



Safety and protection installations

Surge protection



Our products for your project Towards the future with OBO

Reliable, safe and of the highest quality: Product features such as installation speed, load capacity, functionality and availability are at the forefront of each of our innovations. Discover the whole range of OBO products – in a new structure, allowing us to deal in a more targeted manner with the needs of you, our customers.

It is our aim to be the first port of call for the best and most innovative connections for electrical and data technology infrastructure. Thus, when looking towards the future, we have asked ourselves what we can do to be the best possible partner you could ever imagine, also in the long term. Against this backdrop, we have optimised our structure once again, sharpened our profile and defined our services more clearly. The result: Three new areas of application, which replace our previous seven product units, in order to provide you with a contemporary and user-orientated visual identity and structure, for both products and communication. This helps you to find exactly the products you are looking for in an even faster and simpler manner.

In this catalogue, we will present to you the variety of the entire product range of the safety and protection installations application area. Here, one thing – above all else – is in the spotlight: Safety. Besides our expert knowledge in this field, we place particular emphasis on innovations in product development and comprehensive quality testing, in order to offer you maximum protection at all times.

Our products for surge and lightning protection provide reliable protection against the impacts of thunderstorms and remote switching operations. These can cause not only significant damage to property, but also endanger human lives. The unique, wide product range in the field of fire protection makes OBO one of the few providers who cover all three protection aims and help you to protect people and property as best as possible in case of fire.

OBO – simply better.

OBO Product Worlds



Safety and protection installations

- Surge protection
- Explosion protection
- Lightning protection
- Earthing
- Equipotential bonding
- Insulation
- Cable bandages – prevention of the spread of fire
- Escape route installations – false ceiling mounting
- Fire protection ducts
- Systems for the maintenance of electrical functionality – cable-specific routing variants
- Systems for the maintenance of electrical functionality – standard support structures and routing systems
- Systems for the maintenance of electrical functionality – FireBox T series junction boxes
- Anchoring

You can find additional products in our new Industrial installations and Building installations catalogues



Industrial installations

Cable support systems and connection and fastening systems for industry and construction project infrastructure

- Cable trays
- Mesh cable trays
- Cable ladders
- Industrial ducts
- Support structures
- Electrical installation pipes
- Wiring ducts
- Power supply units
- Distributors
- Junction boxes
- Concealed and cavity wall installations
- Terminals
- Cable glands
- Installation and fastening clips
- Anchors and fastening systems



Building installations

Cable routing and underfloor systems for administrative and functional buildings including architectural solutions

- Electrical installation ducts and trunking
- Device installation ducts and trunking
- Skirting trunking
- Service poles
- Underfloor applications, in screed
- Underfloor applications, in concrete
- Underfloor applications, on-floor
- Service outlets for underfloor applications
- Floor sockets and floor boxes
- Installation housing and support
- Tabletop sockets
- Sockets, switches, data and multimedia technology

Contents

Surge protection

Page 10



Explosion protection

Page 220



Directories

Page 242



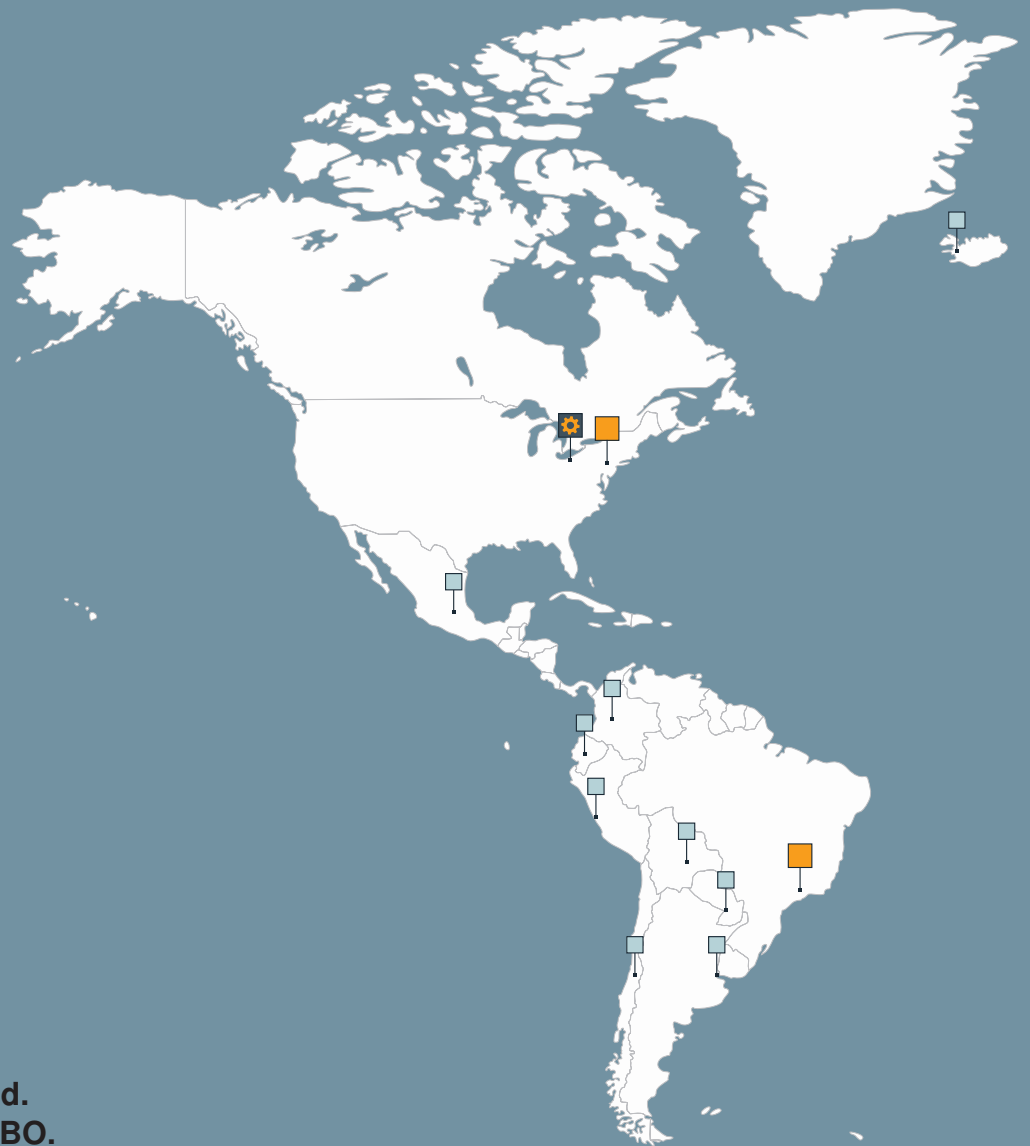

**Welcome world.
Welcome to OBO.**

New solutions to improve functionality and the ease of installation – OBO employees all around the world use their abilities and creativity to make this happen. Because we know that each individual market has its special characteristics and that the requirements for our products change within each market, we have paid particular attention to the compatibility of products in their place of use. We always offer our customers intelligent, well-thought-out solutions. Our brands always keep this promise. The OBO global team wishes to make the work of electrical planners and operatives around the world as easy as possible.

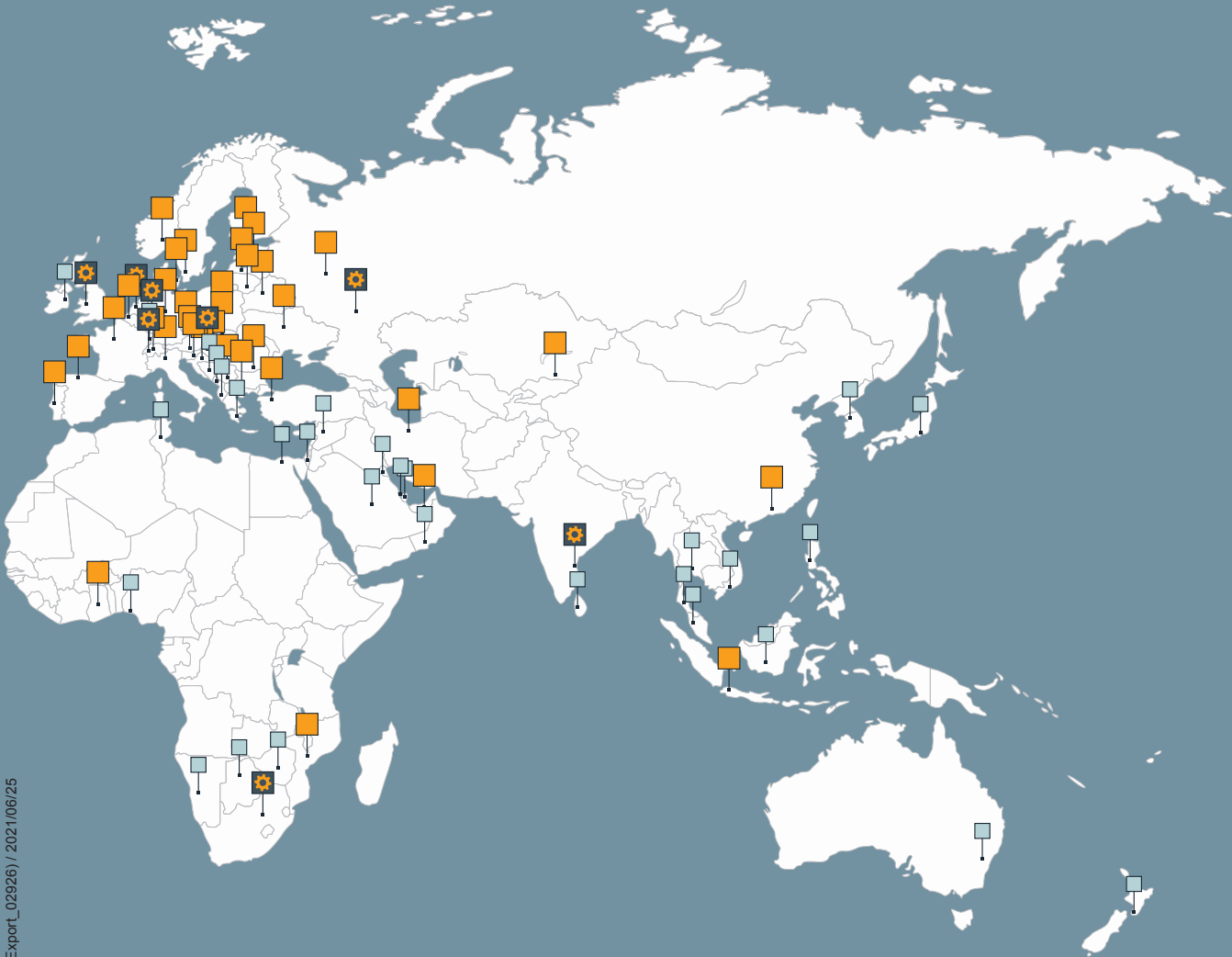

Schutzanlagen Überspannungsschutz und Explosionsschutz / en / 2021/06/25 09:52:32 09:52:32 (LLExpert_02926) / 2021/06/25



Production location



Subsidiary



Representative office

OBO Support & *contact*

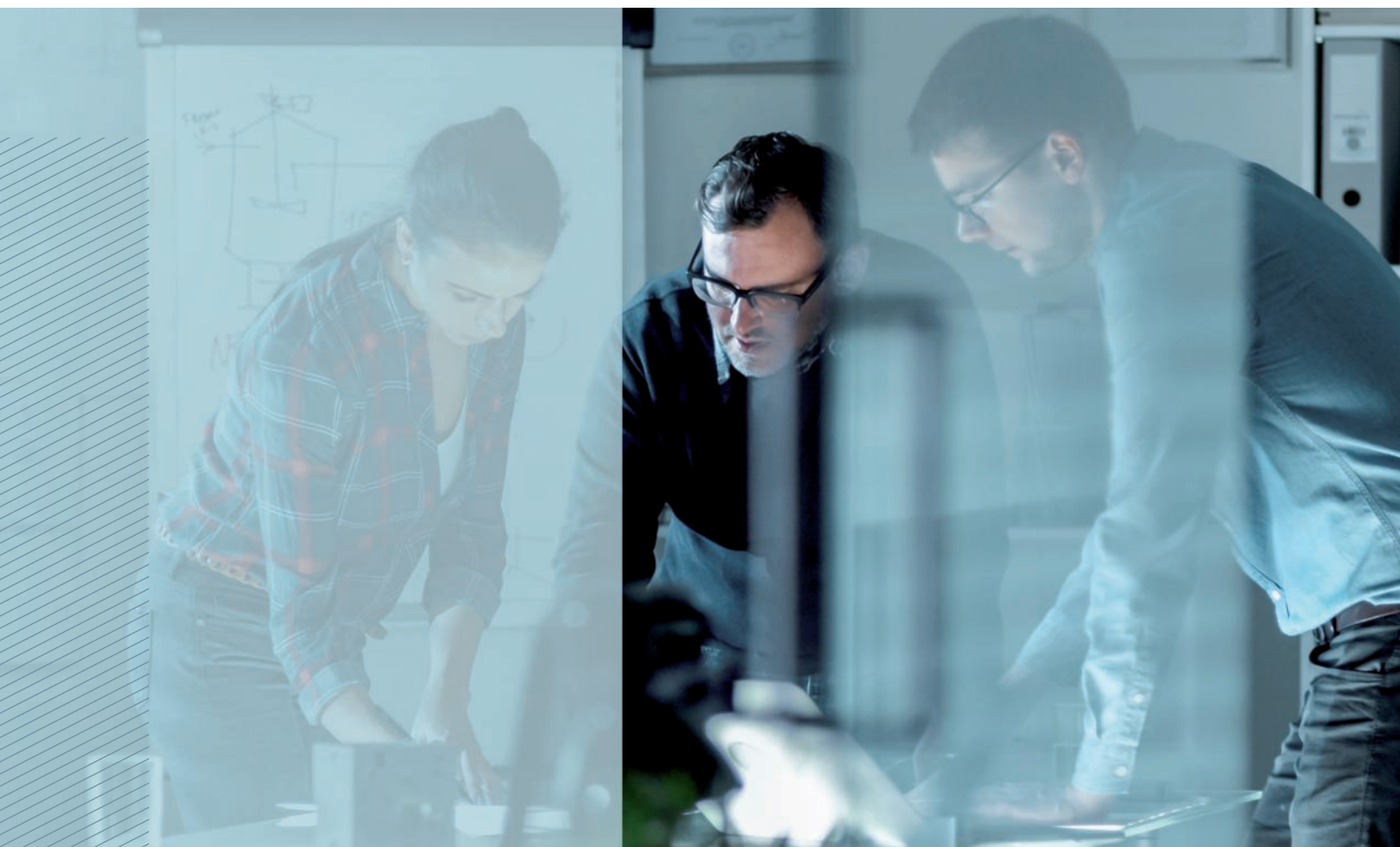

***You have a
problem?
We have the
solution!***

OBO Bettermann is more than the sum of its products. In any situation, we are the reliable partner right by your side. You have a problem? We have the solution!

It doesn't matter in which area of industry our support is needed - from industrial and plant engineering to private, public and administrative buildings, as well as in the areas of mobility and renewable energies - we have all that you need.

OBO can not only provide the entire electro-technical infrastructure with the best possible products. We can also support you with sound expert knowledge and more than 100 years of experience, right from the planning phase through to the realisation of your projects. OBO - solutions you can rely on.

You can contact our Customer Service department on:

+49 2373 89 1700

Monday–Thursday
07.30–17.00

Friday
07.30–15.00

export@obo.de



Service



Training



Handling



Certification

Service – OBO can help

Everywhere and in every project phase:

- Competent hotline
- Product and system information, digitally or printed
- Selection and planning aids on the web, as an app, as a CAD application or in printed form
- 2D and 3D product data for planning
- Field service, branch offices and subsidiaries in 60 countries
- Engineering services for major projects

Training courses from OBO

- Seminars and workshops
- Local consultation and training courses
- Planner days

Handling – OBO delivers reliably

With optimised delivery processes:

- Reliable logistics
- Practical transport systems and packaging
- Loading gear handling and disposal concepts

Certification and guarantee





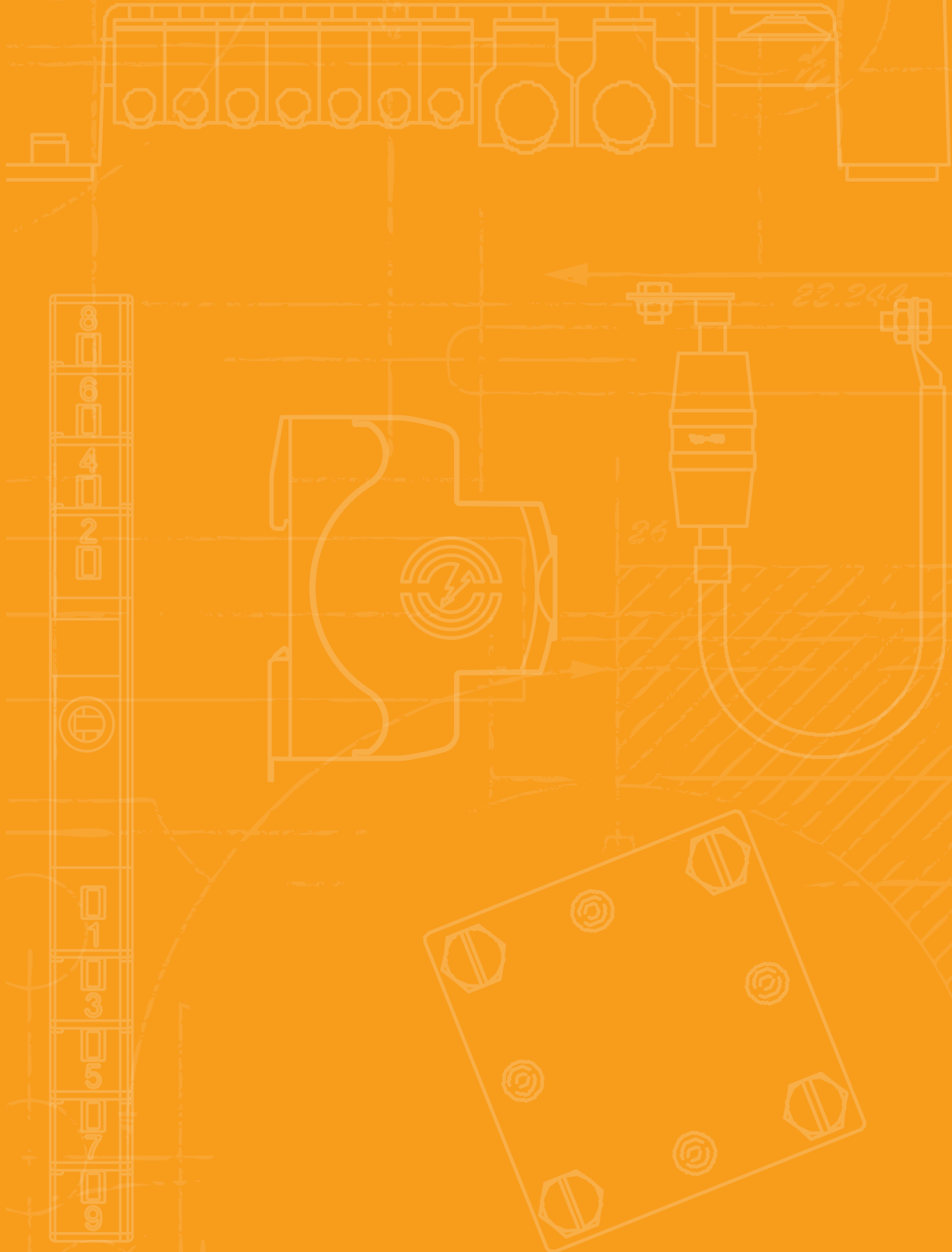

OBO offers safety. Our products fulfil the most important country-specific regulations:

- Conformity (e.g. IEC, VDE, CE, KEMA, KEUR, UL)
- Certification (e.g. DIN EN, DGNB)
- 5-year guarantee for surge protection products
- Guarantee management

Surge protection



Surge protection

| | | |
|---|----------------------------------|-----|
|  | AC power supplies | 12 |
|  | MCR technology | 94 |
|  | Data technology | 134 |
|  | Transmission and reception units | 158 |
|  | PV systems | 174 |
|  | Measuring technology | 210 |
|  | Accessories | 214 |



On the safe side with OBO

With surge protection in the power-side connection compartment (NAR)



According to the IEC/EN standards
IEC 60364-4-44
IEC 60364-5-53
 surge protection is frequently mandatory.



Only 50 mm wide, optionally with FS contact

Solutions from housing to the highest lightning protection class (FPC I)

Type 1+2 surge protection for mounting on 40 mm busbar system

Visual display without power consumption

Screw fastening secures permanent contact to the busbar



LightningController - MCF25-NAR-TNC

| Type | Max. continuous voltage AC V | Pole version | Protection rating | Pack Piece | Weight kg/100 pc. | Item no. |
|---------------|------------------------------|--------------|-------------------|------------|-------------------|----------|
| MCF25-NAR-TNC | 255 | 3 | IP20 | 1 | 100.800 | 5096950 |

Combination arrester, type 1+2, for mounting on 40 mm busbars, for TN-C systems

- Protection level ≤ 1.5 kV to protect the terminals
- Lightning protection equipotential bonding according to VDE 0185-305 (IEC 62305)
- Lightning current arresting capacity up to 25 kA (10/350) 3-pole
- Fulfils the requirements of VDE 0100-534 (IEC 60364-5-53)
- Line follow current quenching up to 50 kA and max. backup fuse up to 160 A gL/gG
- Spark gaps for use in the pre-meter area according to VDE-AR-N 4100

Application: Building with outside cable infeed.

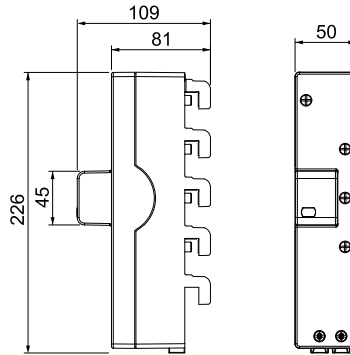

| MCF25-NAR-TNC | | Type 1+2 |
|--|----------------------|-------------------------|
| SPD to EN 61643-11 | | Class II-II |
| SPD to IEC 61643-11 | | |
| Nominal voltage AC (50/60 Hz) | U_n | 230 V |
| Maximum continuous voltage AC | U_C | 255 V |
| Nominal discharge current (8/20 μ s) | $I_n / L-N$ | 20 kA |
| Maximum discharge current (8/20 μ s) | I_{max} | 50 kA |
| Lightning surge current (10/350 μ s) | I_{imp} | 8.5 kA |
| Lightning surge current (10/350) | I_{total} | 25 kA |
| Arrester surge current (8/20 μ s) [total] | I_{total} | 60 kA |
| Combined voltage protection level [L-PEN] | $U_{d/L-PEN}$ | 1.5 kV |
| TOV voltage [L-N] – fail safe mode – 120 min. | $U_{T/L-N, 120 min}$ | 442 V |
| Max. mains-side overcurrent protection | | 160 A |
| Short-circuit withstand for max. mains-side overcurrent protection | | 50 kA eff |
| Operating temperature range | T_u | -40 - +80 °C |
| Protection rating | | IP20 |
| Approvals | | VDE |
| Conductor cross-section, flexible (fine-wire) | | 10 - 35 mm ² |
| Conductor cross-section, rigid (single wire/multi-wire) | | 10 - 35 mm ² |

Connection options

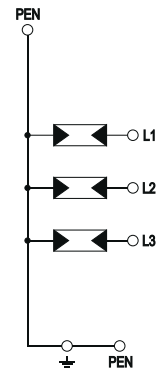

LightningController - MCF25-NAR-TNC+FS

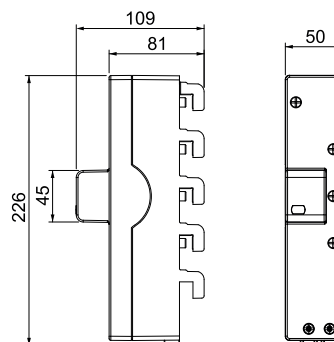
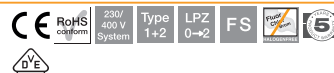

| Type | Max. continuous voltage AC V | Pole version | Protection rating | Pack Piece | Weight kg/100 pc. | Item no. |
|------------------|------------------------------|--------------|-------------------|------------|-------------------|----------|
| MCF25-NAR-TNC+FS | 255 | 3 | IP20 | 1 | 102.000 | 5096953 |

Combination arrester, type 1+2, for mounting on 40 mm busbars, for TN-C systems

- Protection level ≤ 1.5 kV to protect the terminals
- Lightning protection equipotential bonding according to VDE 0185-305 (IEC 62305)
- Lightning current arresting capacity up to 25 kA (10/350) 3-pole
- Fulfills the requirements of VDE 0100-534 (IEC 60364-5-53)
- Line follow current quenching up to 50 kA and max. backup fuse up to 160 A gL/gG
- Spark gaps for use in the pre-meter area according to VDE-AR-N 4100
- With potential-free changeover contact for remote signalling

Application: Building with outside cable infeed.

| MCF25-NAR-TNC+FS | | |
|--|----------------------|---------------------------|
| SPD to EN 61643-11 | | Type 1+2 |
| SPD to IEC 61643-11 | | Class II-II |
| Nominal voltage AC (50/60 Hz) | U_n | 230 V |
| Maximum continuous voltage AC | U_c | 255 V |
| Nominal discharge current (8/20 μ s) | $I_n / L-N$ | 20 kA |
| Maximum discharge current (8/20 μ s) | I_{max} | 50 kA |
| Lightning surge current (10/350 μ s) | I_{imp} | 8.5 kA |
| Lightning surge current (10/350) | I_{total} | 25 kA |
| Arrester surge current (8/20 μ s) [total] | I_{total} | 60 kA |
| Combined voltage protection level [L-PEN] | $U_{p/L-PEN}$ | 1.5 kV |
| TOV voltage [L-N] – fail safe mode – 120 min. | $U_{T/L-N, 120 min}$ | 442 V |
| Max. mains-side overcurrent protection | | 160 A |
| Short-circuit withstand for max. mains-side overcurrent protection | | 50 kA eff |
| Operating temperature range | T_u | -40 - +80 °C |
| Protection rating | | IP20 |
| Approvals | | VDE |
| Conductor cross-section, flexible (fine-wire) | | 10 - 35 mm ² |
| Conductor cross-section, rigid (single wire/multi-wire) | | 10 - 35 mm ² |
| FM contacts | | Changeover |
| Switching power AC | | 250V/ 2A |
| Switching power DC | | 250V/ 0,1A |
| Connection cross-section, FM terminals | | 0,5 - 1,5 mm ² |

Connection options

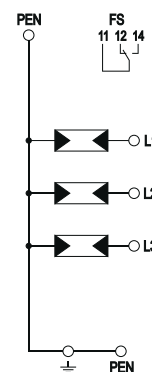



LightningController - MCF30-NAR-TT

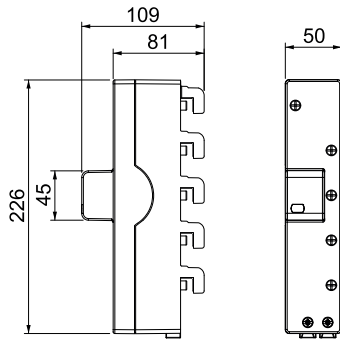

Combination arrester, type 1+2, for mounting on 40 mm busbars, for TN-S and TT systems

- Protection level ≤ 1.5 kV to protect the terminals
- Lightning protection equipotential bonding according to VDE 0185-305 (IEC 62305)
- Lightning current arresting capacity up to 30 kA (10/350) 3+NPE
- Fulfills the requirements of VDE 0100-534 (IEC 60364-5-53)
- Line follow current quenching up to 50 kA and max. backup fuse up to 160 A gL/gG
- Spark gaps for use in the pre-meter area according to VDE-AR-N 4100

Application: Building with outside cable infeed.

| Type | Max. continuous voltage AC V | Pole version | Protection rating | Pack Piece | Weight kg/100 pc. | Item no. |
|--------------|------------------------------|--------------|-------------------|------------|-------------------|----------|
| MCF30-NAR-TT | 255 | 3+N/PE | IP20 | 1 | 107.504 | 5096961 |

Connection options

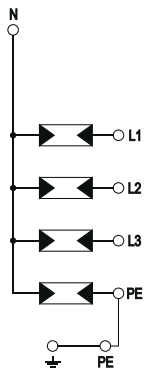

| MCF30-NAR-TT | | |
|--|----------------------|-------------------------|
| SPD to EN 61643-11 | | Type 1+2 |
| SPD to IEC 61643-11 | | Class I+II |
| Nominal voltage AC (50/60 Hz) | U_n | 230 V |
| Maximum continuous voltage AC | U_c | 255 V |
| Nominal discharge current (8/20 μ s) | I_n / L-N | 20 kA |
| Maximum discharge current (8/20 μ s) | I_{max} | 50 kA |
| Lightning surge current (10/350 μ s) | I_{imp} | 7.5 kA |
| Lightning surge current (10/350) | I_{total} | 30 kA |
| Arrester surge current (8/20 μ s) [total] | I_{total} | 80 kA |
| Protection level [L-N] | U_p | 1.5 kV |
| Protection level [N-PE] | U_p / N-PE | 1.5 kV |
| Combined voltage protection level [L-PE] | U_p / L-PE | 2.5 kV |
| TOV voltage [L-N] – fail safe mode – 120 min. | U_T / L-N, 120 min | 442 V |
| TOV voltage [N-PE] – withstand mode – 200 ms | U_T / N-PE, 200 ms | 1200 V |
| Max. mains-side overcurrent protection | | 160 A |
| Short-circuit withstand for max. mains-side overcurrent protection | | 50 kA eff |
| Operating temperature range | T_u | -40 - +80 °C |
| Protection rating | | IP20 |
| Approvals | | VDE |
| Conductor cross-section, flexible (fine-wire) | | 10 - 35 mm ² |
| Conductor cross-section, rigid (single wire/multi-wire) | | 10 - 35 mm ² |



LightningController - MCF30-NAR-TT+FS

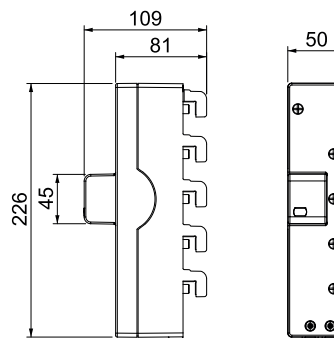
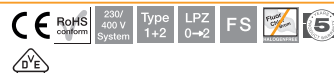

| Type | Max. continuous voltage AC V | Pole version | Protection rating | Pack Piece | Weight kg/100 pc. | Item no. |
|-----------------|------------------------------|--------------|-------------------|------------|-------------------|----------|
| MCF30-NAR-TT+FS | 255 | 3+N/PE | IP20 | 1 | 107.600 | 5096963 |

Combination arrester, type 1+2, for mounting on 40 mm busbars, for TN-S and TT systems

- Protection level ≤ 1.5 kV to protect the terminals
- Lightning protection equipotential bonding according to VDE 0185-305 (IEC 62305)
- Lightning current arresting capacity up to 30 kA (10/350) 3+NPE
- Fulfills the requirements of VDE 0100-534 (IEC 60364-5-53)
- Line follow current quenching up to 50 kA and max. backup fuse up to 160 A gL/gG
- Spark gaps for use in the pre-meter area according to VDE-AR-N 4100
- With potential-free changeover contact for remote signalling

Application: Building with outside cable infeed.

| MCF30-NAR-TT+FS | |
|--|-------------------------------------|
| SPD to EN 61643-11 | Type 1+2 |
| SPD to IEC 61643-11 | Class I+II |
| Nominal voltage AC (50/60 Hz) | U_n 230 V |
| Maximum continuous voltage AC | U_c 255 V |
| Nominal discharge current (8/20 μ s) | $I_n / L-N$ 20 kA |
| Maximum discharge current (8/20 μ s) | I_{max} 50 kA |
| Lightning surge current (10/350 μ s) | I_{imp} 7.5 kA |
| Lightning surge current (10/350) | I_{total} 30 kA |
| Arrester surge current (8/20 μ s) [total] | I_{total} 80 kA |
| Protection level [L-N] | U_p 1.5 kV |
| Protection level [N-PE] | $U_p / N-PE$ 1.5 kV |
| Combined voltage protection level [L-PE] | $U_p / L-PE$ 2.5 kV |
| TOV voltage [L-N] – fail safe mode – 120 min. | $U_T / L-N, 120 \text{ min}$ 442 V |
| TOV voltage [N-PE] – withstand mode – 200 ms | $U_{1/N-PE, 200 \text{ ms}}$ 1200 V |
| Max. mains-side overcurrent protection | 160 A |
| Short-circuit withstand for max. mains-side overcurrent protection | 50 kA eff |
| Operating temperature range | T_u -40 - +80 °C |
| Protection rating | IP20 |
| Approvals | VDE |
| Conductor cross-section, flexible (fine-wire) | 10 - 35 mm ² |
| Conductor cross-section, rigid (single wire/multi-wire) | 10 - 35 mm ² |
| FM contacts | Changeover |
| Switching power AC | 250V/ 2A |
| Switching power DC | 250V/ 0,1A |
| Connection cross-section, FM terminals | 0,5 - 1,5 mm ² |

Connection options

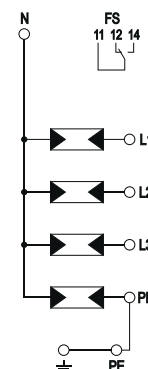



LightningController - MCF38-NAR-TNC

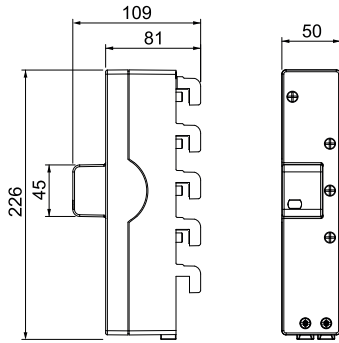

Combination arrester, type 1+2, for mounting on 40 mm busbars, for TN-C systems

- Protection level ≤ 1.5 kV to protect the terminals
- Lightning protection equipotential bonding according to VDE 0185-305 (IEC 62305)
- Lightning current arresting capacity up to 38 kA (10/350) 3-pole
- Fulfills the requirements of VDE 0100-534 (IEC 60364-5-53)
- Line follow current quenching up to 50 kA and max. backup fuse up to 160 A gL/gG
- Spark gaps for use in the pre-meter area according to VDE-AR-N 4100

Application: Building with lightning protection or outside cable infeed.

| Type | Max. continuous voltage AC V | Pole version | Protection rating | Pack Piece | Weight kg/100 pc. | Item no. |
|---------------|------------------------------|--------------|-------------------|------------|-------------------|----------|
| MCF38-NAR-TNC | 255 | 3 | IP20 | 1 | 100.800 | 5096971 |

Connection options

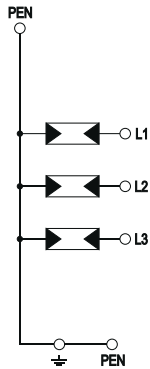

MCF38-NAR-TNC

| | | |
|--|------------------------------|-------------------------|
| SPD to EN 61643-11 | | Type 1+2 |
| SPD to IEC 61643-11 | | Class I+II |
| Nominal voltage AC (50/60 Hz) | U_n | 230 V |
| Maximum continuous voltage AC | U_C | 255 V |
| Nominal discharge current (8/20 μ s) | $I_n / L-N$ | 20 kA |
| Maximum discharge current (8/20 μ s) | I_{max} | 50 kA |
| Lightning surge current (10/350 μ s) | I_{imp} | 12.5 kA |
| Lightning surge current (10/350) | I_{total} | 38 kA |
| Arrester surge current (8/20 μ s) [total] | I_{total} | 60 kA |
| Combined voltage protection level [L-PEN] | $U_d / L-PEN$ | 1.5 kV |
| TOV voltage [L-N] – fail safe mode – 120 min. | $U_T / L-N, 120 \text{ min}$ | 442 V |
| Max. mains-side overcurrent protection | | 160 A |
| Short-circuit withstand for max. mains-side overcurrent protection | | 50 kA eff |
| Operating temperature range | T_u | -40 - +80 °C |
| Protection rating | | IP20 |
| Approvals | | VDE |
| Conductor cross-section, flexible (fine-wire) | | 10 - 35 mm ² |
| Conductor cross-section, rigid (single wire/multi-wire) | | 10 - 35 mm ² |



LightningController – MCF38-NAR-TNC+FS

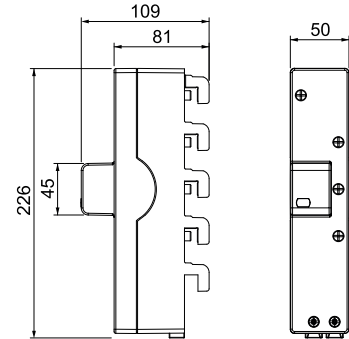
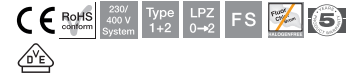

| Type | Max. continuous voltage AC V | Pole version | Protection rating | Pack Piece | Weight kg/100 pc. | Item no. |
|------------------|------------------------------|--------------|-------------------|------------|-------------------|----------|
| MCF38-NAR-TNC+FS | 255 | 3 | IP20 | 1 | 102.000 | 5096973 |

Combination arrester, type 1+2, for mounting on 40 mm busbars, for TN-C systems

- Protection level ≤ 1.5 kV to protect the terminals
- Lightning protection equipotential bonding according to VDE 0185-305 (IEC 62305)
- Lightning current arresting capacity up to 38 kA (10/350) 3-pole
- Fulfills the requirements of VDE 0100-534 (IEC 60364-5-53)
- Line follow current quenching up to 50 kA and max. backup fuse up to 160 A gL/gG
- Spark gaps for use in the pre-meter area according to VDE-AR-N 4100
- With potential-free changeover contact for remote signalling

Application: Buildings with lightning protection or outside cable infeed.

| MCF38-NAR-TNC+FS | | Type 1+2 |
|--|----------------------|---------------------------|
| SPD to EN 61643-11 | | Class II-II |
| Nominal voltage AC (50/60 Hz) | U_n | 230 V |
| Maximum continuous voltage AC | U_c | 255 V |
| Nominal discharge current (8/20 μ s) | $I_n / L-N$ | 20 kA |
| Maximum discharge current (8/20 μ s) | I_{max} | 50 kA |
| Lightning surge current (10/350 μ s) | I_{imp} | 12.5 kA |
| Lightning surge current (10/350) | I_{total} | 38 kA |
| Arrester surge current (8/20 μ s) [total] | I_{total} | 60 kA |
| Combined voltage protection level [L-PEN] | $U_{p/L-PEN}$ | 1.5 kV |
| TOV voltage [L-N] – fail safe mode – 120 min. | $U_{T/L-N, 120 min}$ | 442 V |
| Max. mains-side overcurrent protection | | 160 A |
| Short-circuit withstand for max. mains-side overcurrent protection | | 50 kA eff |
| Operating temperature range | T_u | -40 - +80 °C |
| Protection rating | | IP20 |
| Approvals | | VDE |
| Conductor cross-section, flexible (fine-wire) | | 10 - 35 mm ² |
| Conductor cross-section, rigid (single wire/multi-wire) | | 10 - 35 mm ² |
| FM contacts | | Changeover |
| Switching power AC | | 250V/ 2A |
| Switching power DC | | 250V/ 0,1A |
| Connection cross-section, FM terminals | | 0,5 - 1,5 mm ² |

Connection options

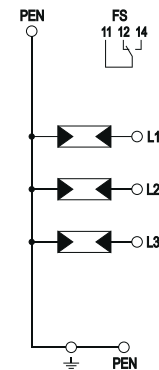



LightningController - MCF50-NAR-TT

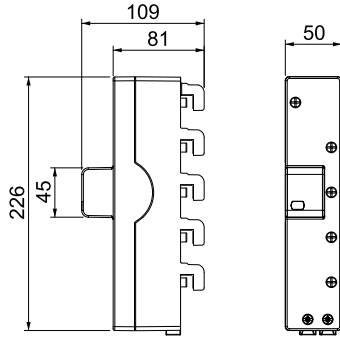

Combination arrester, type 1+2, for mounting on 40 mm busbars, for TN-S and TT systems

- Protection level ≤ 1.5 kV to protect the terminals
- Lightning protection equipotential bonding according to VDE 0185-305 (IEC 62305)
- Lightning current arresting capacity up to 50 kA (10/350) 3+NPE
- Fulfills the requirements of VDE 0100-534 (IEC 60364-5-53)
- Line follow current quenching up to 50 kA and max. backup fuse up to 160 A gL/gG
- Spark gaps for use in the pre-meter area according to VDE-AR-N 4100

Application: Building with lightning protection or outside cable infeed.

| Type | Max. continuous voltage AC V | Pole version | Protection rating | Pack Piece | Weight kg/100 pc. | Item no. |
|--------------|------------------------------|--------------|-------------------|------------|-------------------|----------|
| MCF50-NAR-TT | 255 | 3+N/PE | IP20 | 1 | 106.700 | 5096975 |

Connection options

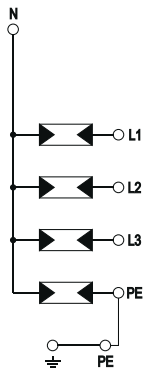

| MCF50-NAR-TT | | Type 1+2 |
|--|------------------------------|-------------------------|
| SPD to EN 61643-11 | | Class I+II |
| SPD to IEC 61643-11 | | |
| Nominal voltage AC (50/60 Hz) | U_n | 230 V |
| Maximum continuous voltage AC | U_C | 255 V |
| Nominal discharge current (8/20 μ s) | $I_n / L-N$ | 20 kA |
| Maximum discharge current (8/20 μ s) | I_{max} | 50 kA |
| Lightning surge current (10/350 μ s) | I_{imp} | 12.5 kA |
| Lightning surge current (10/350) | I_{total} | 50 kA |
| Arrester surge current (8/20 μ s) [total] | I_{total} | 80 kA |
| Protection level [L-N] | U_p | 1.5 kV |
| Protection level [N-PE] | $U_p / N-PE$ | 1.5 kV |
| Combined voltage protection level [L-PE] | $U_p / L-PE$ | 2.5 kV |
| TOV voltage [L-N] – fail safe mode – 120 min. | $U_T / L-N, 120 \text{ min}$ | 442 V |
| TOV voltage [N-PE] – withstand mode – 200 ms | $U_t / N-PE, 200 \text{ ms}$ | 1200 V |
| Max. mains-side overcurrent protection | | 160 A |
| Short-circuit withstand for max. mains-side overcurrent protection | | 50 kA eff |
| Operating temperature range | T_u | -40 - +80 °C |
| Protection rating | | IP20 |
| Approvals | | VDE |
| Conductor cross-section, flexible (fine-wire) | | 10 - 35 mm ² |
| Conductor cross-section, rigid (single wire/multi-wire) | | 10 - 35 mm ² |



LightningController - MCF50-NAR-TT+FS

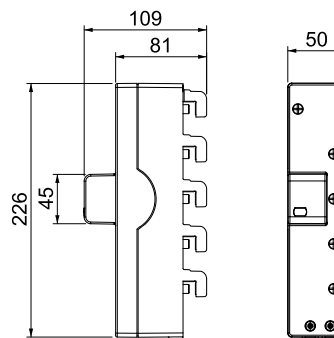
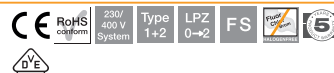

| Type | Max. continuous voltage AC V | Pole version | Protection rating | Pack Piece | Weight kg/100 pc. | Item no. |
|-----------------|------------------------------|--------------|-------------------|------------|-------------------|----------|
| MCF50-NAR-TT+FS | 255 | 3+N/PE | IP20 | 1 | 107.500 | 5096977 |

Combination arrester, type 1+2, for mounting on 40 mm busbars, for TN-S and TT systems

- Protection level ≤ 1.5 kV to protect the terminals
- Lightning protection equipotential bonding according to VDE 0185-305 (IEC 62305)
- Lightning current arresting capacity up to 50 kA (10/350) 3+NPE
- Fulfills the requirements of VDE 0100-534 (IEC 60364-5-53)
- Line follow current quenching up to 50 kA and max. backup fuse up to 160 A gL/gG
- Spark gaps for use in the pre-meter area according to VDE-AR-N 4100
- With potential-free changeover contact for remote signalling

Application: Building with lightning protection or outside cable infeed.

| MCF50-NAR-TT+FS | |
|--|-------------------------------------|
| SPD to EN 61643-11 | Type 1+2 |
| SPD to IEC 61643-11 | Class I+II |
| Nominal voltage AC (50/60 Hz) | U_n 230 V |
| Maximum continuous voltage AC | U_c 255 V |
| Nominal discharge current (8/20 μ s) | $I_n / L-N$ 20 kA |
| Maximum discharge current (8/20 μ s) | I_{max} 50 kA |
| Lightning surge current (10/350 μ s) | I_{imp} 12.5 kA |
| Lightning surge current (10/350) | I_{total} 50 kA |
| Arrester surge current (8/20 μ s) [total] | I_{total} 80 kA |
| Protection level [L-N] | U_p 1.5 kV |
| Protection level [N-PE] | $U_p / N-PE$ 1.5 kV |
| Combined voltage protection level [L-PE] | $U_p / L-PE$ 2.5 kV |
| TOV voltage [L-N] – fail safe mode – 120 min. | $U_T / L-N, 120 \text{ min}$ 442 V |
| TOV voltage [N-PE] – withstand mode – 200 ms | $U_{1/N-PE, 200 \text{ ms}}$ 1200 V |
| Max. mains-side overcurrent protection | 160 A |
| Short-circuit withstand for max. mains-side overcurrent protection | 50 kA eff |
| Operating temperature range | T_u -40 - +80 °C |
| Protection rating | IP20 |
| Approvals | VDE |
| Conductor cross-section, flexible (fine-wire) | 10 - 35 mm ² |
| Conductor cross-section, rigid (single wire/multi-wire) | 10 - 35 mm ² |
| FM contacts | Changeover |
| Switching power AC | 250V/ 2A |
| Switching power DC | 250V/ 0,1A |
| Connection cross-section, FM terminals | 0,5 - 1,5 mm ² |

Connection options

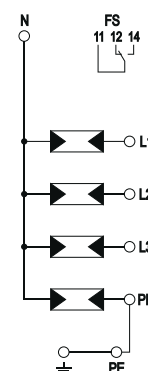



LightningController – MCF75-NAR-TNC

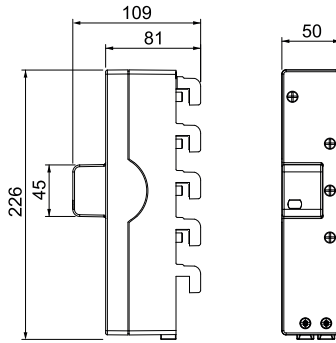

Combination arrester, type 1+2, for mounting on 40 mm busbars, for TN-C systems

- Protection level ≤ 1.5 kV to protect the terminals
- Lightning protection equipotential bonding according to VDE 0185-305 (IEC 62305)
- Lightning current arresting capacity up to 75 kA (10/350) 3-pole
- Fulfills the requirements of VDE 0100-534 (IEC 60364-5-53)
- Line follow current quenching up to 50 kA and max. backup fuse up to 315 A gL/gG
- Spark gaps for use in the pre-meter area according to VDE-AR-N 4100

Application: Building with lightning protection or outside cable infeed.

| Type | Max. continuous voltage AC V | Pole version | Protection rating | Pack Piece | Weight kg/100 pc. | Item no. |
|---------------|------------------------------|--------------|-------------------|------------|-------------------|----------|
| MCF75-NAR-TNC | 255 | 3 | IP20 | 1 | 100.800 | 5096982 |

Connection options

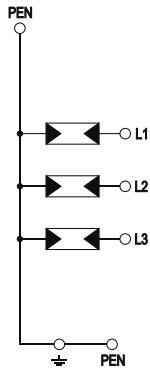

| MCF75-NAR-TNC | | Type 1+2 |
|--|------------------------------|-------------------------|
| SPD to EN 61643-11 | | Class I+II |
| SPD to IEC 61643-11 | | |
| Nominal voltage AC (50/60 Hz) | U_n | 230 V |
| Maximum continuous voltage AC | U_C | 255 V |
| Nominal discharge current (8/20 μ s) | $I_n / L-N$ | 25 kA |
| Maximum discharge current (8/20 μ s) | I_{max} | 50 kA |
| Lightning surge current (10/350 μ s) | I_{imp} | 25 kA |
| Lightning surge current (10/350) | I_{total} | 75 kA |
| Arrester surge current (8/20 μ s) [total] | I_{total} | 75 kA |
| Combined voltage protection level [L-PEN] | $U_d / L-PEN$ | 1.5 kV |
| TOV voltage [L-N] – fail safe mode – 120 min. | $U_T / L-N, 120 \text{ min}$ | 442 V |
| Max. mains-side overcurrent protection | | 315 A |
| Short-circuit withstand for max. mains-side overcurrent protection | | 50 kA eff |
| Operating temperature range | T_u | -40 - +80 °C |
| Protection rating | | IP20 |
| Approvals | | VDE |
| Conductor cross-section, flexible (fine-wire) | | 10 - 35 mm ² |
| Conductor cross-section, rigid (single wire/multi-wire) | | 10 - 35 mm ² |



LightningController - MCF75-NAR-TNC+FS

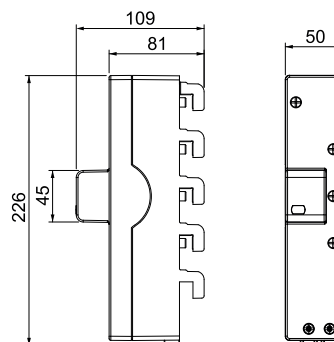
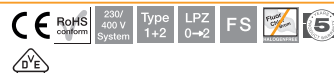

| Type | Max. continuous voltage AC V | Pole version | Protection rating | Pack Piece | Weight kg/100 pc. | Item no. |
|------------------|------------------------------|--------------|-------------------|------------|-------------------|----------|
| MCF75-NAR-TNC+FS | 255 | 3 | IP20 | 1 | 102.000 | 5096983 |

Combination arrester, type 1+2, for mounting on 40 mm busbars, for TN-C systems

- Protection level ≤ 1.5 kV to protect the terminals
- Lightning protection equipotential bonding according to VDE 0185-305 (IEC 62305)
- Lightning current arresting capacity up to 75 kA (10/350) 3-pole
- Fulfills the requirements of VDE 0100-534 (IEC 60364-5-53)
- Line follow current quenching up to 50 kA and max. backup fuse up to 315 A gL/gG
- Spark gaps for use in the pre-meter area according to VDE-AR-N 4100
- With potential-free changeover contact for remote signalling

Application: Buildings with lightning protection or outside cable infeed.

| MCF75-NAR-TNC+FS | | |
|--|----------------------|---------------------------|
| SPD to EN 61643-11 | | Type 1+2 |
| SPD to IEC 61643-11 | | Class II-II |
| Nominal voltage AC (50/60 Hz) | U_n | 230 V |
| Maximum continuous voltage AC | U_c | 255 V |
| Nominal discharge current (8/20 μ s) | $I_n / L-N$ | 25 kA |
| Maximum discharge current (8/20 μ s) | I_{max} | 50 kA |
| Lightning surge current (10/350 μ s) | I_{imp} | 25 kA |
| Lightning surge current (10/350) | I_{total} | 75 kA |
| Arrester surge current (8/20 μ s) [total] | I_{total} | 75 kA |
| Combined voltage protection level [L-PEN] | $U_{p/L-PEN}$ | 1.5 kV |
| TOV voltage [L-N] – fail safe mode – 120 min. | $U_{T/L-N, 120 min}$ | 442 V |
| Max. mains-side overcurrent protection | | 315 A |
| Short-circuit withstand for max. mains-side overcurrent protection | | 50 kA eff |
| Operating temperature range | T_u | -40 - +80 °C |
| Protection rating | | IP20 |
| Approvals | | VDE |
| Conductor cross-section, flexible (fine-wire) | | 10 - 35 mm ² |
| Conductor cross-section, rigid (single wire/multi-wire) | | 10 - 35 mm ² |
| FM contacts | | Changeover |
| Switching power AC | | 250V/ 2A |
| Switching power DC | | 250V/ 0,1A |
| Connection cross-section, FM terminals | | 0,5 - 1,5 mm ² |

Connection options

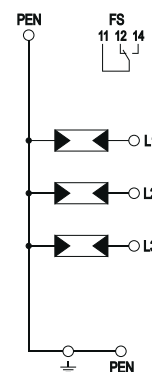



LightningController - MCF100-NAR-TT

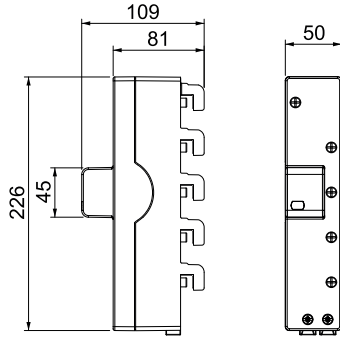

Combination arrester, type 1+2, for mounting on 40 mm busbars, for TN-S and TT systems

- Protection level ≤ 1.5 kV to protect the terminals
- Lightning protection equipotential bonding according to VDE 0185-305 (IEC 62305)
- Lightning current arresting capacity up to 100 kA (10/350) 3+NPE
- Fulfills the requirements of VDE 0100-534 (IEC 60364-5-53)
- Line follow current quenching up to 50 kA and max. backup fuse up to 315 A gL/gG
- Spark gaps for use in the pre-meter area according to VDE-AR-N 4100

Application: Building with lightning protection or outside cable infeed.

| Type | Max. continuous voltage AC V | Pole version | Protection rating | Pack Piece | Weight kg/100 pc. | Item no. |
|---------------|------------------------------|--------------|-------------------|------------|-------------------|----------|
| MCF100-NAR-TT | 255 | 3+N/PE | IP20 | 1 | 107.200 | 5096985 |

Connection options

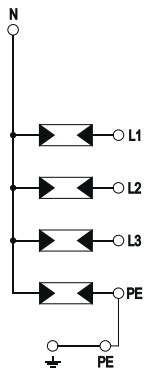

| MCF100-NAR-TT | | Type 1+2 |
|--|------------------------------|-------------------------|
| SPD to EN 61643-11 | | Class I-II |
| SPD to IEC 61643-11 | | |
| Nominal voltage AC (50/60 Hz) | U_n | 230 V |
| Maximum continuous voltage AC | U_C | 255 V |
| Nominal discharge current (8/20 μ s) | $I_n / L-N$ | 25 kA |
| Maximum discharge current (8/20 μ s) | I_{max} | 50 kA |
| Lightning surge current (10/350 μ s) | I_{imp} | 25 kA |
| Lightning surge current (10/350) | I_{total} | 100 kA |
| Arrester surge current (8/20 μ s) [total] | I_{total} | 100 kA |
| Protection level [L-N] | U_p | 1.5 kV |
| Protection level [N-PE] | $U_p / N-PE$ | 1.5 kV |
| Combined voltage protection level [L-PE] | $U_p / L-PE$ | 2.5 kV |
| TOV voltage [L-N] – fail safe mode – 120 min. | $U_T / L-N, 120 \text{ min}$ | 442 V |
| TOV voltage [N-PE] – withstand mode – 200 ms | $U_T / N-PE, 200 \text{ ms}$ | 1200 V |
| Max. mains-side overcurrent protection | | 315 A |
| Short-circuit withstand for max. mains-side overcurrent protection | | 50 kA eff |
| Operating temperature range | T_u | -40 - +80 °C |
| Protection rating | | IP20 |
| Approvals | | VDE |
| Conductor cross-section, flexible (fine-wire) | | 10 - 35 mm ² |
| Conductor cross-section, rigid (single wire/multi-wire) | | 10 - 35 mm ² |



LightningController - MCF100-NAR-TT+FS

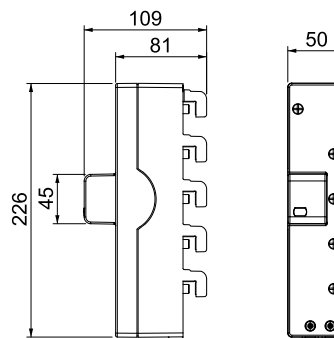
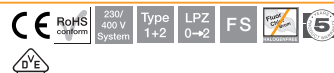

| Type | Max. continuous voltage AC V | Pole version | Protection rating | Pack Piece | Weight kg/100 pc. | Item no. |
|------------------|------------------------------|--------------|-------------------|------------|-------------------|----------|
| MCF100-NAR-TT+FS | 255 | 3+N/PE | IP20 | 1 | 107.600 | 5096988 |

Combination arrester, type 1+2, for mounting on 40 mm busbars, for TN-S and TT systems

- Protection level ≤ 1.5 kV to protect the terminals
- Lightning protection equipotential bonding according to VDE 0185-305 (IEC 62305)
- Lightning current arresting capacity up to 100 kA (10/350) 3+NPE
- Fulfills the requirements of VDE 0100-534 (IEC 60364-5-53)
- Line follow current quenching up to 50 kA and max. backup fuse up to 315 A gL/gG
- Spark gaps for use in the pre-meter area according to VDE-AR-N 4100
- With potential-free changeover contact for remote signalling

Application: Building with lightning protection or outside cable infeed.

| MCF100-NAR-TT+FS | |
|--|-----------------------------|
| SPD to EN 61643-11 | Type 1+2 |
| SPD to IEC 61643-11 | Class I+II |
| Nominal voltage AC (50/60 Hz) | U_n 230 V |
| Maximum continuous voltage AC | U_c 255 V |
| Nominal discharge current (8/20 μ s) | I_n / L-N 25 kA |
| Maximum discharge current (8/20 μ s) | I_{max} 50 kA |
| Lightning surge current (10/350 μ s) | I_{imp} 25 kA |
| Lightning surge current (10/350) | I_{total} 100 kA |
| Arrester surge current (8/20 μ s) [total] | I_{total} 100 kA |
| Protection level [L-N] | U_p 1.5 kV |
| Protection level [N-PE] | U_p / N-PE 1.5 kV |
| Combined voltage protection level [L-PE] | U_p / L-PE 2.5 kV |
| TOV voltage [L-N] – fail safe mode – 120 min. | U_T / L-N, 120 min 442 V |
| TOV voltage [N-PE] – withstand mode – 200 ms | U_1 / N-PE, 200 ms 1200 V |
| Max. mains-side overcurrent protection | 315 A |
| Short-circuit withstand for max. mains-side overcurrent protection | 50 kA eff |
| Operating temperature range | T_u -40 - +80 °C |
| Protection rating | IP20 |
| Approvals | VDE |
| Conductor cross-section, flexible (fine-wire) | 10 - 35 mm ² |
| Conductor cross-section, rigid (single wire/multi-wire) | 10 - 35 mm ² |
| FM contacts | Changeover |
| Switching power AC | 250V/ 2A |
| Switching power DC | 250V/ 0,1A |
| Connection cross-section, FM terminals | 0,5 - 1,5 mm ² |

Connection options

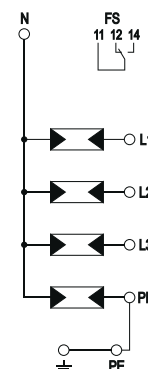



LightningController Compact - MCF75

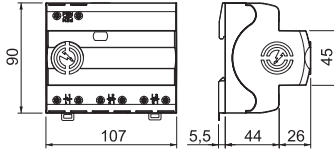

Combination arrester, lightning current and surge arrester, type 1+2

- Protection level ≤ 1.5 kV
- For lightning protection equipotential bonding to VDE 0185-305 (IEC 62305)
- Lightning current arresting capacity to 75 kA (10/350), 3-pole
- Line following current quenching 50 kA I_{peak}, arrester backup fuse to 315 A gL/gG
- Fulfills the requirements of VDE-AR-N 4100 for use in pre-meter area
- Encapsulated, non-extinguishing spark gap arrester for use in distributor housings

Application: Industrial systems and buildings with external lightning protection of the highest class I to IV.

| Type | Max. continuous voltage AC V | Pole version | Protection rating | Pack Piece | Weight kg/100 pc. | Item no. |
|------------|------------------------------|--------------|-------------------|------------|-------------------|----------|
| MCF75-3+FS | 255 | 3 | IP20 | 1 | 75.000 | 5096981 |

Connection options

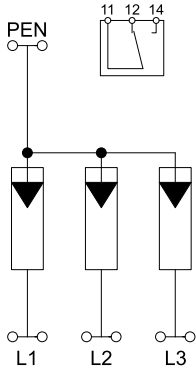

MCF75-3+FS

| | | |
|--|------------------------|--------------------------|
| SPD to EN 61643-11 | | Type 1+2 |
| SPD to IEC 61643-11 | | Class I+II |
| SPD to UL 1449 | | Type 4 |
| Nominal voltage AC (50/60 Hz) | U _n | 230 V |
| Maximum continuous voltage AC | U _c | 255 V |
| Nominal discharge current (8/20 μ s) | I _n / L-N | 35 kA |
| Maximum discharge current (8/20 μ s) | I _{max} | 50 kA |
| Lightning surge current (10/350 μ s) | I _{imp} | 25 kA |
| Lightning surge current (10/350) | I _{total} | 75 kA |
| Arrester surge current (8/20 μ s) [total] | I _{total} | 75 kA |
| Combined voltage protection level [L-PEN] | U _p / L-PEN | 1.5 kV |
| Max. mains-side overcurrent protection | | 315 A |
| Short-circuit withstand for max. mains-side overcurrent protection | | 50 kA eff |
| Operating temperature range | T _u | -40 - +80 °C |
| Protection rating | | IP20 |
| Approvals | | VDE, UL |
| Conductor cross-section, flexible (fine-wire) | | 1.5 - 25 mm ² |
| Conductor cross-section, rigid (single wire/multi-wire) | | 1.5 - 35 mm ² |
| Conductor cross-section, flexible (fine-wire) | | 16 - 3 AWG |
| Conductor cross-section, rigid (single wire/multi-wire) | | 16 - 2 AWG |



LightningController Compact - MCF100

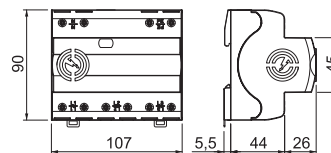

| Type | Max. continuous voltage AC V | Pole version | Protection rating | Pack Piece | Weight kg/100 pc. | Item no. |
|-----------------|------------------------------|--------------|-------------------|------------|-------------------|----------|
| MCF100-3+NPE+FS | 255 | 3+N/PE | IP20 | 1 | 93.500 | 5096987 |

Combination arrester, lightning current and surge arrester, type 1+2

- Protection level ≤ 1.5 kV
- For lightning protection equipotential bonding to VDE 0185-305 (IEC 62305)
- Lightning current arresting capacity up to 100 kA (10/350), 3+NPE
- Line following current quenching 50 kA Ipeak, arrester backup fuse to 315 A gL/gG
- Fulfills the requirements of VDE-AR-N 4100 for use in pre-meter area
- Encapsulated, non-extinguishing spark gap arrester for use in distributor housings

Application: Industrial systems and buildings with external lightning protection of the highest class I to IV.

| MCF100-3+NPE+FS | |
|--|--------------------------|
| SPD to EN 61643-11 | Type 1+2 |
| SPD to IEC 61643-11 | Class I+II |
| SPD to UL 1449 | Type 4 |
| Nominal voltage AC (50/60 Hz) | U_n 230 V |
| Maximum continuous voltage AC | U_c 255 V |
| Nominal discharge current (8/20 μ s) | $I_{n/L-N}$ 35 kA |
| Maximum discharge current (8/20 μ s) | I_{max} 50 kA |
| Lightning surge current (10/350 μ s) | I_{imp} 25 kA |
| Lightning surge current (10/350) | I_{total} 100 kA |
| Arrester surge current (8/20 μ s) [total] | I_{total} 100 kA |
| Protection level [L-N] | U_p 1.5 kV |
| Max. mains-side overcurrent protection | 315 A |
| Short-circuit withstand for max. mains-side overcurrent protection | 50 kA eff |
| Operating temperature range | T_u -40 - +80 °C |
| Protection rating | IP20 |
| Approvals | VDE, UL |
| Conductor cross-section, flexible (fine-wire) | 1.5 - 25 mm ² |
| Conductor cross-section, rigid (single wire/multi-wire) | 1.5 - 35 mm ² |
| Conductor cross-section, flexible (fine-wire) | 16 - 3 AWG |
| Conductor cross-section, rigid (single wire/multi-wire) | 16 - 2 AWG |

Connection options

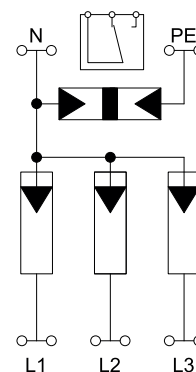



Combination arrester, 1-pole

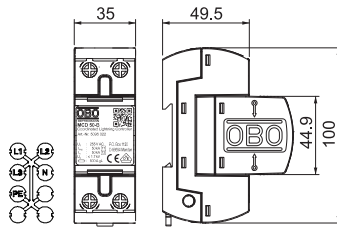

Combination arrester, type 1+2, for use in TN and TT networks

- Lightning protection equipotential bonding to VDE 0185-305 (IEC 62305)
- Lightning current arresting capacity to 50 kA (10/350) per pole and up to 150 kA (10/350) in total
- Protection level < 1.7 kV allows device protection
- Short-circuit resistance 10 kA, arrester backup fuse to 500 A gL/gG
- Suitable for use in pre-meter area
- Encapsulated, non-extinguishing spark gaps

Application: Industrial systems and buildings with external lightning protection of the highest class I to IV.

| Type | Highest continuous voltage V | Version | Pack | Weight | Item no. |
|----------|------------------------------|---------|-------|------------|----------|
| | | | Piece | kg/100 pc. | |
| MCD 50-B | 255 | 1-pole | 1 | 34.400 | 5096849 |

Connection options

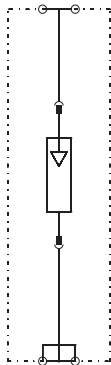

| MCD 50-B | | |
|--|------------------|-------------------------|
| Nominal voltage | U_N | 230 V |
| Max. continuous operating voltage | U_C | 255 V |
| SPD to EN 61643-11 | | Type 1+2 |
| SPD to IEC 61643-11 | | Class I+II |
| Lightning protection zone LPZ | | 0-2 |
| Impulse discharge current (10/350) | I_{imp} | 50 kA |
| Lightning surge current (10/350) | I_{total} | 50 kA |
| Nominal discharge current (8/20) | I_n | 50 kA |
| Arrester surge current (8/20) [total] | $I_{Total 8/20}$ | 50 kA |
| Protection level | U_p | < 1,7 kV |
| Response time | t_A | <100 ns |
| Follow current quenching capacity leff | $I_{fi\ eff}$ | 10 kA |
| Maximum back-up fuse | | 500 A |
| Temperature range | ϑ | -40 - +85 °C |
| Division unit TE (17.5 mm) | | 2 |
| Protection rating | | IP20 |
| Approvals | | VDE |
| Connection cross-section, rigid | | 10 - 50 mm ² |
| Connection cross-section, multi-wire | | 10 - 35 mm ² |
| Connection cross-section, flexible | | 10 - 25 mm ² |



Combination arrester, 1-pole with function display

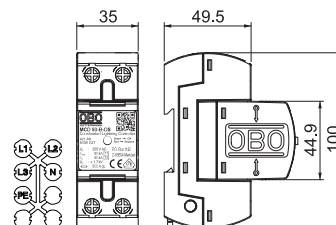

| Type | Highest continuous voltage V | Version | Pack Piece | Weight kg/100 pc. | Item no. |
|-------------|------------------------------|---------|------------|-------------------|----------|
| MCD 50-B-OS | 255 | 1-pole | 1 | 34.800 | 5096852 |

Combination arrester, type 1+2, 1-pole, for use in TN and TT networks:

MCD 50-B-OS: Coordinated lightning current arrester, type 1+2 to EN 61643-11 with visual function display. For interface 0 to 2 (LPZ) in accordance with lightning protection zone concept to IEC 61312-1 and/or DIN VDE 0185-305.

- Arresting capacity 50 kA (10/350 μs) per pole
- Power consumption < 26 mW/pole
- Protection level < 1.7 kV, allows device protection
- Line follow current quenching 25 kA Ipeak
- Incl. plug caps for labelling the connections
- Encapsulated, non-extinguishing spark gap
- Can be used in standard distributor housings.

Application: Compact surge protection concepts and installations in a distributor.

| MCD 50-B-OS | | | |
|--|------------------|--|-------------------------|
| Nominal voltage | U_N | | 230 V |
| Max. continuous operating voltage | U_C | | 255 V |
| SPD to EN 61643-11 | | | Type 1+2 |
| SPD to IEC 61643-11 | | | Class I+II |
| Lightning protection zone LPZ | | | 0→2 |
| Impulse discharge current (10/350) | I_{imp} | | 50 kA |
| Lightning surge current (10/350) | I_{total} | | 50 kA |
| Nominal discharge current (8/20) | I_n | | 50 kA |
| Arrestor surge current (8/20) [total] | $I_{Total 8/20}$ | | 50 kA |
| Protection level | U_p | | < 1,7 kV |
| Response time | t_A | | <100 ns |
| Follow current quenching capacity Ieff | $I_{fi eff}$ | | 10 kA |
| Maximum back-up fuse | | | 500 A |
| Temperature range | ϑ | | -40 - +85 °C |
| Division unit TE (17.5 mm) | | | 2 |
| Protection rating | | | IP20 |
| Approvals | | | VDE |
| Connection cross-section, rigid | | | 10 - 50 mm ² |
| Connection cross-section, multi-wire | | | 10 - 35 mm ² |
| Connection cross-section, flexible | | | 10 - 25 mm ² |

Connection options

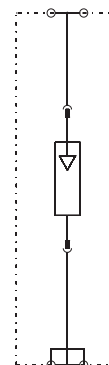

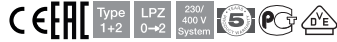

Combination arrester, 1-pole NPE

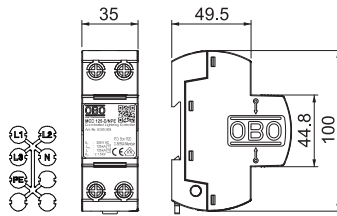

Combination arrester, type 1+2, N+PE for use in TN-S and TT networks.

MCD 125-B/NPE: Coordinated N-PE spark gap, type 1+2 to EN 61643-11. For interface 0 to 2 (LPZ) in accordance with lightning protection zone concept to IEC 61312-1 and/or VDE 0185-305.

- Arresting capacity 125 kA (10/350 μ s)
- Conforms to VDE-AR-N 4100
- Incl. plug caps for labelling the connections
- Protection level < 1.5 kV, allows device protection
- Encapsulated, non-extinguishing spark gap

Application: Industrial systems and buildings with external lightning protection of Classes I to IV.

| Type | Highest continuous voltage V | Version | Pack Piece | Weight kg/100 pc. | Item no. |
|---------------|------------------------------|---------|------------|-------------------|----------|
| MCD 125-B NPE | 255 | NPE | 1 | 46.500 | 5096865 |

Connection options

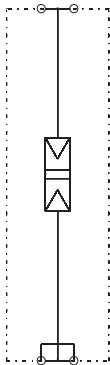

MCD 125-B NPE

| | | |
|--|-------------------|-------------------------|
| Nominal voltage | U_N | 230 V |
| Max. continuous operating voltage | U_C | 255 V |
| SPD to EN 61643-11 | | Type 1+2 |
| SPD to IEC 61643-11 | | Class I+II |
| Lightning protection zone LPZ | | 0→2 |
| Impulse discharge current (10/350) | I_{imp} | 125 kA |
| Lightning surge current (10/350) | I_{total} | 125 kA |
| Nominal discharge current (8/20) | I_n | 125 kA |
| Arrestor surge current (8/20) [total] | $I_{Total\ 8/20}$ | 125 kA |
| Protection level (N-PE) | | < 1,5 kV |
| Response time | t_A | <100 ns |
| Follow current quenching capacity (eff) [N-PE] | I_{fi} | 0.1 kA |
| Temperature range | ϑ | -40 - +85 °C |
| Division unit TE (17.5 mm) | | 2 |
| Protection rating | | IP20 |
| Approvals | | VDE |
| Connection cross-section, rigid | | 10 - 50 mm ² |
| Connection cross-section, multi-wire | | 10 - 35 mm ² |
| Connection cross-section, flexible | | 10 - 25 mm ² |



Combination arrester, 3-pole

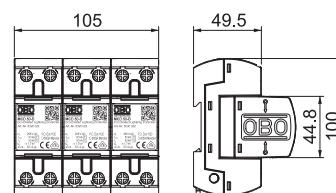

| Type | Highest continuous voltage V | Version | Pack Piece | Weight kg/100 pc. | Item no. |
|------------|------------------------------|---------|------------|-------------------|----------|
| MCD 50-B 3 | 255 | 3-pole | 1 | 117.000 | 5096877 |

Combination arrester, type 1+2, 3-pole, for use in TN-C networks.

Completely pre-terminated and ready for connection, consisting of: 3x MCD 50-B: Type 1+2 (Class B) coordinated lightning current arrester EN 61643-11. For interface 0 to 2 (LPZ) in accordance with lightning protection zone concept to IEC 61312-1 and/or VDE 0185-305.

- Lightning protection equipotential bonding to VDE 0185-305 (IEC 62305)
- Lightning current arresting capacity to 50 kA (10/350) per pole and up to 150 kA (10/350) in total
- Protection level < 1.7 kV allows device protection
- Short-circuit resistance 10 kA, arrester backup fuse to 500 A gL/gG
- Suitable for use in pre-meter area according to VDE-AR-N 4100
- Encapsulated, non-extinguishing spark gaps

Application: Industrial systems and buildings with external lightning protection of the Classes I to IV.

| MCD 50-B 3 | | |
|---|------------------|-------------------------|
| Nominal voltage | U_N | 230 V |
| Max. continuous operating voltage | U_C | 255 V |
| SPD to EN 61643-11 | | Type 1+2 |
| SPD to IEC 61643-11 | | Class I+II |
| Lightning protection zone LPZ | | 0→2 |
| Impulse discharge current (10/350) | I_{imp} | 50 kA |
| Lightning surge current (10/350) | I_{total} | 150 kA |
| Nominal discharge current (8/20) | I_n | 50 kA |
| Arrester surge current (8/20) [total] | $I_{Total 8/20}$ | 150 kA |
| Protection level | U_p | < 1,7 kV |
| Response time | t_A | <100 ns |
| Follow current quenching capacity I_{eff} | $I_{fi eff}$ | 10 kA |
| Maximum back-up fuse | | 500 A |
| Temperature range | ϑ | -40 - +85 °C |
| Division unit TE (17.5 mm) | | 6 |
| Protection rating | | IP20 |
| Approvals | | VDE |
| Connection cross-section, rigid | | 10 - 50 mm ² |
| Connection cross-section, multi-wire | | 10 - 35 mm ² |
| Connection cross-section, flexible | | 10 - 25 mm ² |

Connection options

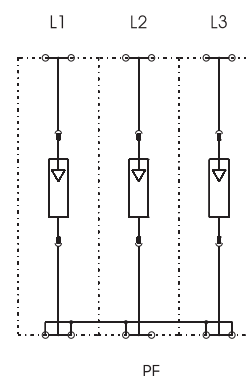



Combination arrester, 3-pole with function display

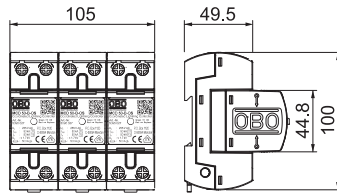

Combination arrester set, type 1+2, 3-pole, with visual function display, for use in TN-C networks:

Completely pre-terminated and ready for connection, consisting of:
3 x MCD 50-B-OS: Type 1+2 coordinated lightning current arresters to DIN EN 61643-11. For interface 0 to 2 (LPZ) in accordance with lightning protection zone concept to IEC 61312-1 and/or VDE 0185-305.

- Lightning protection equipotential bonding to VDE 0185-305 (IEC 62305)
- Lightning current arresting capacity to 50 kA (10/350) per pole and up to 150 kA (10/350) in total
- Protection level < 1.7 kV allows device protection
- Short-circuit resistance 10 kA, arrester backup fuse to 500 A gL/gG
- Power consumption < 26 mW/pole
- Encapsulated, non-extinguishing spark gaps

Application: Industrial systems and buildings with external lightning protection of Classes I to IV.

| Type | Highest continuous voltage V | Version | Pack Piece | Weight kg/100 pc. | Item no. |
|---------------|------------------------------|---------|------------|-------------------|----------|
| MCD 50-B 3-OS | 255 | 3-pole | 1 | 118.000 | 5096835 |

Connection options

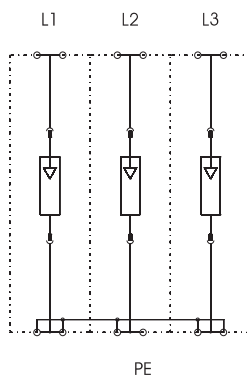

MCD 50-B 3-OS

| | | |
|--|------------------|-------------------------|
| Nominal voltage | U_N | 230 V |
| Max. continuous operating voltage | U_C | 255 V |
| SPD to EN 61643-11 | | Type 1+2 |
| SPD to IEC 61643-11 | | Class I+II |
| Lightning protection zone LPZ | | 0→2 |
| Impulse discharge current (10/350) | I_{imp} | 50 kA |
| Lightning surge current (10/350) | I_{total} | 150 kA |
| Nominal discharge current (8/20) | I_n | 50 kA |
| Arrester surge current (8/20) [total] | $I_{Total 8/20}$ | 150 kA |
| Protection level | U_p | < 1,7 kV |
| Response time | t_A | <100 ns |
| Follow current quenching capacity leff | $I_{fi eff}$ | 10 kA |
| Maximum back-up fuse | | 500 A |
| Temperature range | ϑ | -40 - +85 °C |
| Division unit TE (17.5 mm) | | 6 |
| Protection rating | | IP20 |
| Approvals | | VDE |
| Connection cross-section, rigid | | 10 - 50 mm ² |
| Connection cross-section, multi-wire | | 10 - 35 mm ² |
| Connection cross-section, flexible | | 10 - 25 mm ² |



Combination arrester, 3-pole + NPE

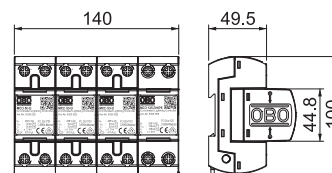

| Type | Highest continuous voltage V | Version | Pack Piece | Weight kg/100 pc. | Item no. |
|--------------|------------------------------|---------|------------|-------------------|----------|
| MCD 50-B 3+1 | 255 | 3 + NPE | 1 | 168.000 | 5096879 |

Combination arrester, type 1+2, 4-pole, for use in TT and TN-S networks.

Completely pre-terminated and ready for connection, consisting of:
 3x MCD 50-B: Coordinated lightning current arrester, type 1+2 to EN 61643-11 and
 1x MCD 125-B/NPE: Coordinated N-PE spark gap, type 1+2 to EN 61643-11. For interface 0 to 2 (LPZ) in accordance with lightning protection zone concept to IEC 61312-1 and/or VDE 0185-305.

- Lightning protection equipotential bonding to VDE 0185-305 (IEC 62305)
- Lightning current arresting capacity to 50 kA (10/350) per pole and up to 125 kA (10/350) in total
- Protection level < 1.7 kV allows device protection
- Short-circuit resistance 10 kA, arrester backup fuse to 500 A gL/gG
- Suitable for use in pre-meter area according to VDE-AR-N 4100
- Encapsulated, non-extinguishing spark gaps

Application: Industrial systems and buildings with external lightning protection of the classes I to IV.

| MCD 50-B 3+1 | | |
|--|------------------|-------------------------|
| Nominal voltage | U_N | 230 V |
| Max. continuous operating voltage | U_C | 255 V |
| SPD to EN 61643-11 | | Type 1+2 |
| SPD to IEC 61643-11 | | Class I+II |
| Lightning protection zone LPZ | | 0→2 |
| Impulse discharge current (10/350) | I_{imp} | 50 kA |
| Lightning surge current (10/350) | I_{total} | 125 kA |
| Nominal discharge current (8/20) | I_n | 50 kA |
| Arrester surge current (8/20) [total] | $I_{Total 8/20}$ | 125 kA |
| Protection level | U_p | < 1,7 kV |
| Protection level (N-PE) | | < 1,5 kV |
| Response time | t_A | <100 ns |
| Follow current quenching capacity I_{eff} | $I_{fi eff}$ | 10 kA |
| Follow current quenching capacity (eff) [N-PE] | I_{fi} | 0.1 kA |
| Maximum back-up fuse | | 500 A |
| Temperature range | ϑ | -40 - +85 °C |
| Division unit TE (17.5 mm) | | 8 |
| Protection rating | | IP20 |
| Approvals | | VDE |
| Connection cross-section, rigid | | 10 - 50 mm ² |
| Connection cross-section, multi-wire | | 10 - 35 mm ² |
| Connection cross-section, flexible | | 10 - 25 mm ² |

Connection options

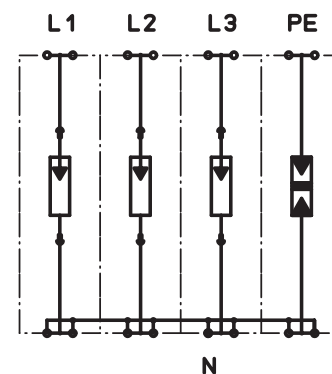

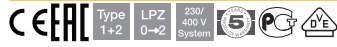

Combination arrester, 3-pole + NPE with function display

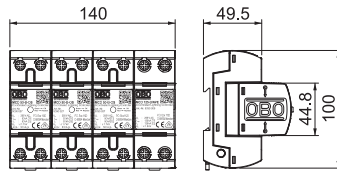

Combination arrester, type 1+2, 4-pole, with visual function display, for use in TN-S and TT networks.

Completely pre-terminated and ready for connection, consisting of:
 3x MCD 50-B-OS: Type 1+2 (Class B) coordinated lightning current arrester EN 61643-11.
 1x MCD 125-B/NPE: Coordinated N-PE spark gap, type 1+2 EN 61643-11 for use in TN-S and TT systems.
 Interface 0 to 1 according to lightning protection zone concept according to IEC 61312-1 and VDE 0185-305.

- Lightning protection equipotential bonding to VDE 0185-305 (IEC 62305)
- Lightning current arresting capacity to 50 kA (10/350) per pole and up to 125 kA (10/350) in total
- Protection level < 1.7 kV allows device protection
- Short-circuit resistance 10 kA, arrester backup fuse to 500 A gL/gG
- Power consumption < 26 mW/pole
- Encapsulated, non-extinguishing spark gap

Application: Industrial systems and buildings with external lightning protection of Classes I to IV.

| Type | Highest continuous voltage V | Version | Pack Piece | Weight kg/100 pc. | Item no. |
|-----------------|------------------------------|---------|------------|-------------------|----------|
| MCD 50-B 3+1-OS | 255 | 3+ NPE | 1 | 172.000 | 5096836 |

Connection options

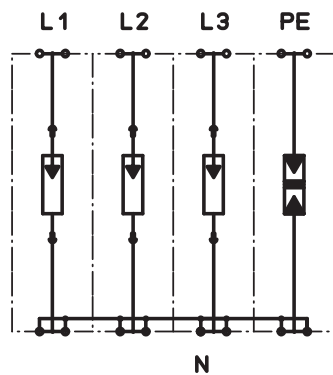

MCD 50-B 3+1-OS

| | | |
|--|------------------|-------------------------|
| Nominal voltage | U_N | 230 V |
| Max. continuous operating voltage | U_C | 255 V |
| SPD to EN 61643-11 | | Type 1+2 |
| SPD to IEC 61643-11 | | Class I+II |
| Lightning protection zone LPZ | | 0→2 |
| Impulse discharge current (10/350) | I_{imp} | 50 kA |
| Lightning surge current (10/350) | I_{total} | 125 kA |
| Nominal discharge current (8/20) | I_n | 50 kA |
| Arrester surge current (8/20) [total] | $I_{Total 8/20}$ | 125 kA |
| Protection level | U_p | < 1,7 kV |
| Protection level (N-PE) | | < 1,5 kV |
| Response time | t_A | <100 ns |
| Follow current quenching capacity leff | $I_{fi eff}$ | 10 kA |
| Follow current quenching capacity (eff) [N-PE] | I_{fi} | 0.1 kA |
| Maximum back-up fuse | | 500 A |
| Temperature range | ϑ | -40 - +85 °C |
| Division unit TE (17.5 mm) | | 8 |
| Protection rating | | IP20 |
| Approvals | | VDE |
| Connection cross-section, rigid | | 10 - 50 mm ² |
| Connection cross-section, multi-wire | | 10 - 35 mm ² |
| Connection cross-section, flexible | | 10 - 25 mm ² |

Combination arrester MCF Compact

Surge protection energy technology, arrester, type 1+2



- Type 1 + 2 SPD: $I_{imp} = 25$ kA per pole and up to 100 kA in total
- Protection level: < 1.5 kV, usable in coordination with type 3 SPD
- Usable in buildings with lightning protection class 1–4
- Quality according to EN 61643-11 certified by an external testing institute
- Universally usable for industry, offices, commercial and residential buildings
- System protection up to 315 A usable without separate fusing
- Remote signalling, potential-free changeover (RS)
- Variants in three to three-pole+NPE versions
- Operating instructions always available online via QR code
- Space savings of up to 25% (compared to MCD variant)

PA

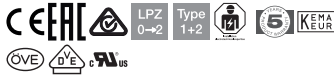

Combination arrester V50, 1-pole 280 V

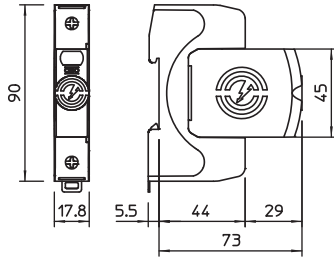

Lightning current combination arrester, type 1+2

- For lightning current equipotential bonding to VDE 0185-305 (IEC 62305)
- Lightning current arresting capacity of 12.5 kA (10/350) per pole and up to 50 kA (10/350) in total
- Modular, plug-in arrester with cut-off unit and visual status display
- Locking mechanism with vibration protection and voltage keying
- Plastic to UL 94 V-0
- The remote signalling (FS) variants have a potential-free changeover contact for remote signalling

Application: Lightning current equipotential bonding for buildings of class III and IV.

| Type | Max. continuous voltage AC V | Pole version | Protection rating | Pack Piece | Weight kg/100 pc. | Item no. |
|-----------|------------------------------|--------------|-------------------|------------|-------------------|----------|
| V50-1-280 | 280 | 1 | IP20 | 1 | 16.400 | 5093500 |

Connection options

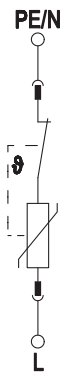

| V50-1-280 | |
|--|--------------------------|
| SPD to EN 61643-11 | Type 1+2 |
| SPD to IEC 61643-11 | Class I+II |
| SPD to UL 1449 | Type 4 |
| Nominal voltage AC (50/60 Hz) | U_n 230 V |
| Maximum continuous voltage AC | U_C 280 V |
| Nominal discharge current (8/20 μ s) | $I_{n/L-N}$ 30 kA |
| Maximum discharge current (8/20 μ s) | I_{max} 50 kA |
| Lightning surge current (10/350 μ s) | I_{imp} 12.5 kA |
| Protection level [L-N] | U_p 1.3 kV |
| Residual voltage [L-N] @ 1 kA | U_{res} 0,7 kV |
| Residual voltage [L-N] @ 5 kA | U_{res} 0,8 kV |
| Max. mains-side overcurrent protection | 160 A gL/gG |
| Short-circuit withstand for max. mains-side overcurrent protection | 50 kA eff |
| Operating temperature range | T_u -40 - +80 °C |
| Protection rating | IP20 |
| Approvals | UL, KEMA, ÖVE, VDE |
| Conductor cross-section, flexible (fine-wire) | 1.5 - 35 mm ² |
| Conductor cross-section, rigid (single wire/multi-wire) | 1.5 - 35 mm ² |
| Conductor cross-section, flexible (fine-wire) | 16 - 2 AWG |
| Conductor cross-section, rigid (single wire/multi-wire) | 16 - 2 AWG |



Combination arrester V50, 1-pole + NPE 280 V

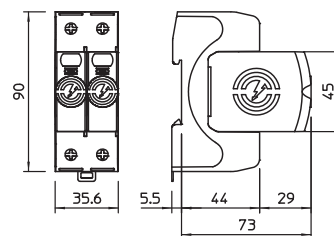

| Type | Max. continuous voltage AC V | Pole version | Protection rating | Pack Piece | Weight kg/100 pc. | Item no. |
|---------------|------------------------------|--------------|-------------------|------------|-------------------|----------|
| V50-1+NPE-280 | 280 | 1+N/PE | IP20 | 1 | 32.929 | 5093522 |

Lightning current combination arrester, type 1+2

- For lightning current equipotential bonding to VDE 0185-305 (IEC 62305)
- Lightning current arresting capacity of 12.5 kA (10/350) per pole and up to 50 kA (10/350) in total
- Modular, plug-in arrester with cut-off unit and visual status display
- Locking mechanism with vibration protection and voltage keying
- Plastic to UL 94 V-0
- The remote signalling (FS) variants have a potential-free change-over contact for remote signalling

Application: Lightning current equipotential bonding for buildings of class III and IV.

| V50-1+NPE-280 | |
|--|--------------------------|
| SPD to EN 61643-11 | Type 1+2 |
| SPD to IEC 61643-11 | Class I+II |
| SPD to UL 1449 | Type 4 |
| Nominal voltage AC (50/60 Hz) | U_n 230 V |
| Maximum continuous voltage AC | U_c 280 V |
| Nominal discharge current (8/20 μ s) | $I_n / L-N$ 30 kA |
| Maximum discharge current (8/20 μ s) | I_{max} 50 kA |
| Lightning surge current (10/350 μ s) | I_{imp} 12.5 kA |
| Lightning surge current (10/350) | I_{total} 25 kA |
| Arrester surge current (8/20 μ s) [total] | I_{total} 80 kA |
| Protection level [L-N] | U_p 1.3 kV |
| Combined voltage protection level [L-PE] | $U_{p/L-PE}$ 2.5 kV |
| Residual voltage [L-N] @ 1 kA | U_{res} 0,7 kV |
| Residual voltage [L-N] @ 5 kA | U_{res} 0,8 kV |
| Max. mains-side overcurrent protection | 160 A gL/gG |
| Short-circuit withstand for max. mains-side overcurrent protection | 50 kA eff |
| Operating temperature range | T_u -40 - +80 °C |
| Protection rating | IP20 |
| Approvals | UL, KEMA, ÖVE, VDE |
| Conductor cross-section, flexible (fine-wire) | 1.5 - 35 mm ² |
| Conductor cross-section, rigid (single wire/multi-wire) | 1.5 - 35 mm ² |
| Conductor cross-section, flexible (fine-wire) | 16 - 2 AWG |
| Conductor cross-section, rigid (single wire/multi-wire) | 16 - 2 AWG |

Connection options

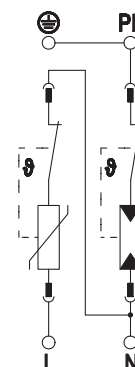

PA



Combination arrester V50, 1-pole with FS 280 V

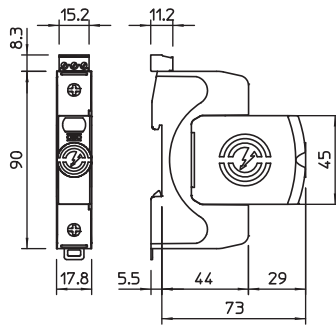

Lightning current combination arrester, type 1+2

- For lightning current equipotential bonding to VDE 0185-305 (IEC 62305)
- Lightning current arresting capacity of 12.5 kA (10/350) per pole and up to 50 kA (10/350) in total
- Modular, plug-in arrester with cut-off unit and visual status display
- Locking mechanism with vibration protection and voltage keying
- Plastic to UL 94 V-0
- The remote signalling (FS) variants have a potential-free changeover contact for remote signalling

Application: Lightning current equipotential bonding for buildings of class III and IV.

| Type | Max. continuous voltage AC V | Pole version | Protection rating | Pack Piece | Weight kg/100 pc. | Item no. |
|---------------------|------------------------------|--------------|-------------------|------------|-------------------|----------------|
| V50-1+FS-280 | 280 | 1 | IP20 | 1 | 16.600 | 5093502 |

Connection options

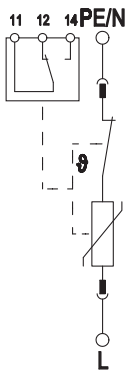

V50-1+FS-280

| | |
|--|----------------------------|
| SPD to EN 61643-11 | Type 1+2 |
| SPD to IEC 61643-11 | Class I+II |
| SPD to UL 1449 | Type 4 |
| Nominal voltage AC (50/60 Hz) | U_n 230 V |
| Maximum continuous voltage AC | U_C 280 V |
| Nominal discharge current (8/20 μ s) | $I_{n/L-N}$ 30 kA |
| Maximum discharge current (8/20 μ s) | I_{max} 50 kA |
| Lightning surge current (10/350 μ s) | I_{imp} 12.5 kA |
| Protection level [L-N] | U_p 1.3 kV |
| Residual voltage [L-N] @ 1 kA | U_{res} 0,7 kV |
| Residual voltage [L-N] @ 5 kA | U_{res} 0,8 kV |
| Max. mains-side overcurrent protection | 160 A gL/gG |
| Short-circuit withstand for max. mains-side overcurrent protection | 50 kA eff |
| Operating temperature range | T_u -40 - +80 °C |
| Protection rating | IP20 |
| Approvals | UL, KEMA, ÖVE, VDE |
| FM contacts | Changeover |
| Switching power AC | 230 V; 0,5 A |
| Switching power DC | 230 V; 0,1 A / 75 V; 0,5 A |
| Connection cross-section, FM terminals | 0,5 - 1,5 mm ² |
| Connection cross-section, FM terminals | 21 - 16 AWG |
| Conductor cross-section, flexible (fine-wire) | 1,5 - 35 mm ² |
| Conductor cross-section, rigid (single wire/multi-wire) | 1,5 - 35 mm ² |
| Conductor cross-section, flexible (fine-wire) | 16 - 2 AWG |
| Conductor cross-section, rigid (single wire/multi-wire) | 16 - 2 AWG |



Combination arrester V50, 1-pole + NPE with FS 280 V

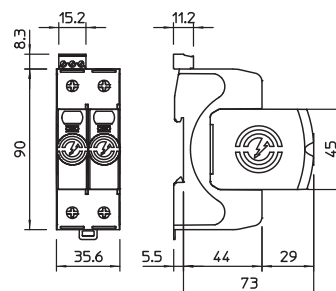

| Type | Max. continuous voltage AC V | Pole version | Protection rating | Pack Piece | Weight kg/100 pc. | Item no. |
|------------------|------------------------------|--------------|-------------------|------------|-------------------|----------|
| V50-1+NPE+FS-280 | 280 | 1+N/PE | IP20 | 1 | 30.600 | 5093531 |

Lightning current combination arrester, type 1+2

- For lightning current equipotential bonding to VDE 0185-305 (IEC 62305)
- Lightning current arresting capacity of 12.5 kA (10/350) per pole and up to 50 kA (10/350) in total
- Modular, plug-in arrester with cut-off unit and visual status display
- Locking mechanism with vibration protection and voltage keying
- Plastic to UL 94 V-0
- The remote signalling (FS) variants have a potential-free changeover contact for remote signalling

Application: Lightning current equipotential bonding for buildings of class III and IV.

| V50-1+NPE+FS-280 | |
|--|----------------------------|
| SPD to EN 61643-11 | Type 1+2 |
| SPD to IEC 61643-11 | Class I+II |
| SPD to UL 1449 | Type 4 |
| Nominal voltage AC (50/60 Hz) | U_n 230 V |
| Maximum continuous voltage AC | U_c 280 V |
| Nominal discharge current (8/20 μ s) | $I_n / L-N$ 30 kA |
| Maximum discharge current (8/20 μ s) | I_{max} 50 kA |
| Lightning surge current (10/350 μ s) | I_{imp} 12.5 kA |
| Lightning surge current (10/350) | I_{total} 25 kA |
| Arrester surge current (8/20 μ s) [total] | I_{total} 80 kA |
| Protection level [L-N] | U_d 1.3 kV |
| Combined voltage protection level [L-PE] | $U_{d/L-PE}$ 2.5 kV |
| Residual voltage [L-N] @ 1 kA | U_{res} 0,7 kV |
| Residual voltage [L-N] @ 5 kA | U_{res} 0,8 kV |
| Max. mains-side overcurrent protection | 160 A gL/gG |
| Short-circuit withstand for max. mains-side overcurrent protection | 50 kA eff |
| Operating temperature range | T_u -40 - +80 °C |
| Protection rating | IP20 |
| Approvals | UL, KEMA, ÖVE, VDE |
| FM contacts | Changeover |
| Switching power AC | 230 V; 0,5 A |
| Switching power DC | 230 V; 0,1 A / 75 V; 0,5 A |
| Connection cross-section, FM terminals | 0,5 - 1,5 mm ² |
| Connection cross-section, FM terminals | 21 - 16 AWG |
| Conductor cross-section, flexible (fine-wire) | 1.5 - 35 mm ² |
| Conductor cross-section, rigid (single wire/multi-wire) | 1.5 - 35 mm ² |
| Conductor cross-section, flexible (fine-wire) | 16 - 2 AWG |
| Conductor cross-section, rigid (single wire/multi-wire) | 16 - 2 AWG |

Connection options

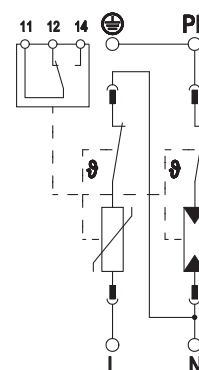

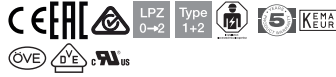

Combination arrester V50, 2-pole + NPE 280 V

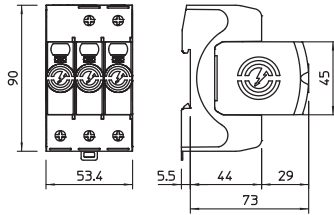

Lightning current combination arrester, type 1+2

- For lightning current equipotential bonding to VDE 0185-305 (IEC 62305)
- Lightning current arresting capacity of 12.5 kA (10/350) per pole and up to 50 kA (10/350) in total
- Modular, plug-in arrester with cut-off unit and visual status display
- Locking mechanism with vibration protection and voltage keying
- Plastic to UL 94 V-0
- The remote signalling (FS) variants have a potential-free change-over contact for remote signalling

Application: Lightning current equipotential bonding for buildings of class III and IV.

| Type | Max. continuous voltage AC V | Pole version | Protection rating | Pack Piece | Weight kg/100 pc. | Item no. |
|---------------|------------------------------|--------------|-------------------|------------|-------------------|----------|
| V50-2+NPE-280 | 280 | 2+N/PE | IP20 | 1 | 44.300 | 5093524 |

Connection options

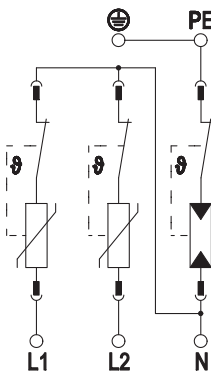

| V50-2+NPE-280 | |
|--|--------------------------|
| SPD to EN 61643-11 | Type 1+2 |
| SPD to IEC 61643-11 | Class I-II |
| SPD to UL 1449 | Type 4 |
| Nominal voltage AC (50/60 Hz) | U_n 230 V |
| Maximum continuous voltage AC | U_c 280 V |
| Nominal discharge current (8/20 μ s) | $I_n / L-N$ 30 kA |
| Maximum discharge current (8/20 μ s) | I_{max} 50 kA |
| Lightning surge current (10/350 μ s) | I_{imp} 12.5 kA |
| Lightning surge current (10/350) | I_{total} 37.5 kA |
| Arrester surge current (8/20 μ s) [total] | I_{total} 80 kA |
| Protection level [L-N] | U_o 1.3 kV |
| Combined voltage protection level [L-PE] | $U_{p/L-PE}$ 2.5 kV |
| Residual voltage [L-N] @ 1 kA | U_{res} 0,7 kV |
| Residual voltage [L-N] @ 5 kA | U_{res} 0,8 kV |
| Max. mains-side overcurrent protection | 160 A gL/gG |
| Short-circuit withstand for max. mains-side overcurrent protection | 50 kA eff |
| Operating temperature range | T_u -40 - +80 °C |
| Protection rating | IP20 |
| Approvals | UL, KEMA, ÖVE, VDE |
| Conductor cross-section, flexible (fine-wire) | 1.5 - 35 mm ² |
| Conductor cross-section, rigid (single wire/multi-wire) | 1.5 - 35 mm ² |
| Conductor cross-section, flexible (fine-wire) | 16 - 2 AWG |
| Conductor cross-section, rigid (single wire/multi-wire) | 16 - 2 AWG |



Combination arrester V50, 3-pole 280 V

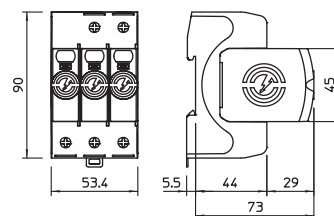

| Type | Max. continuous voltage AC V | Pole version | Protection rating | Pack Piece | Weight kg/100 pc. | Item no. |
|-----------|------------------------------|--------------|-------------------|------------|-------------------|----------|
| V50-3-280 | 280 | 3 | IP20 | 1 | 46.500 | 5093511 |

Lightning current combination arrester, type 1+2

- For lightning current equipotential bonding to VDE 0185-305 (IEC 62305)
- Lightning current arresting capacity of 12.5 kA (10/350) per pole and up to 50 kA (10/350) in total
- Modular, plug-in arrester with cut-off unit and visual status display
- Locking mechanism with vibration protection and voltage keying
- Plastic to UL 94 V-0
- The remote signalling (FS) variants have a potential-free change-over contact for remote signalling

Application: Lightning current equipotential bonding for buildings of class III and IV.

| V50-3-280 | |
|--|--------------------------|
| SPD to EN 61643-11 | Type 1+2 |
| SPD to IEC 61643-11 | Class I+II |
| SPD to UL 1449 | Type 4 |
| Nominal voltage AC (50/60 Hz) | U_n 230 V |
| Maximum continuous voltage AC | U_C 280 V |
| Nominal discharge current (8/20 μ s) | $I_n / L-N$ 30 kA |
| Maximum discharge current (8/20 μ s) | I_{max} 50 kA |
| Lightning surge current (10/350 μ s) | I_{limp} 12.5 kA |
| Lightning surge current (10/350) | I_{total} 37.5 kA |
| Arrester surge current (8/20 μ s) [total] | I_{total} 120 kA |
| Protection level [L-N] | U_p 1.3 kV |
| Residual voltage [L-N] @ 1 kA | U_{res} 0,7 kV |
| Residual voltage [L-N] @ 5 kA | U_{res} 0,8 kV |
| Max. mains-side overcurrent protection | 160 A gL/gG |
| Short-circuit withstand for max. mains-side overcurrent protection | 50 kA eff |
| Operating temperature range | T_u -40 - +80 °C |
| Protection rating | IP20 |
| Approvals | UL, KEMA, ÖVE, VDE |
| Conductor cross-section, flexible (fine-wire) | 1.5 - 35 mm ² |
| Conductor cross-section, rigid (single wire/multi-wire) | 1.5 - 35 mm ² |
| Conductor cross-section, flexible (fine-wire) | 16 - 2 AWG |
| Conductor cross-section, rigid (single wire/multi-wire) | 16 - 2 AWG |

Connection options

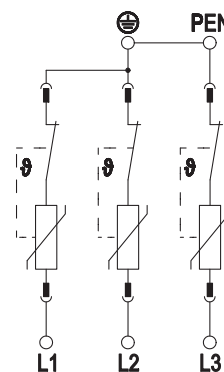



Combination arrester V50, 3-pole with FS 280 V

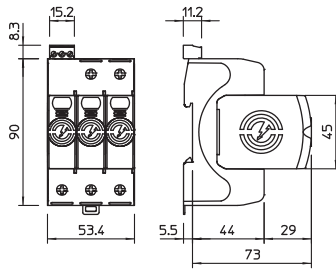

Lightning current combination arrester, type 1+2

- For lightning current equipotential bonding to VDE 0185-305 (IEC 62305)
- Lightning current arresting capacity of 12.5 kA (10/350) per pole and up to 50 kA (10/350) in total
- Modular, plug-in arrester with cut-off unit and visual status display
- Locking mechanism with vibration protection and voltage keying
- Plastic to UL 94 V-0
- The remote signalling (FS) variants have a potential-free changeover contact for remote signalling

Application: Lightning current equipotential bonding for buildings of class III and IV.

| Type | Max. continuous voltage AC V | Pole version | Protection rating | Pack Piece | Weight kg/100 pc. | Item no. |
|--------------|------------------------------|--------------|-------------------|------------|-------------------|----------|
| V50-3+FS-280 | 280 | 3 | IP20 | 1 | 46.900 | 5093516 |

Connection options

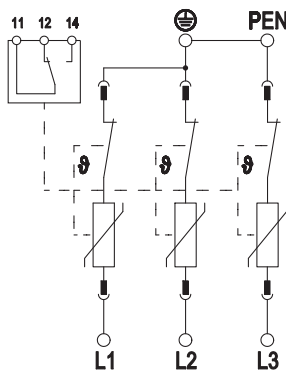

| V50-3+FS-280 | |
|--|----------------------------|
| SPD to EN 61643-11 | Type 1+2 |
| SPD to IEC 61643-11 | Class I+II |
| SPD to UL 1449 | Type 4 |
| Nominal voltage AC (50/60 Hz) | U_n 230 V |
| Maximum continuous voltage AC | U_c 280 V |
| Nominal discharge current (8/20 μ s) | $I_n / L-N$ 30 kA |
| Maximum discharge current (8/20 μ s) | I_{max} 50 kA |
| Lightning surge current (10/350 μ s) | I_{imp} 12.5 kA |
| Lightning surge current (10/350) | I_{total} 37.5 kA |
| Arrester surge current (8/20 μ s) [total] | I_{total} 120 kA |
| Protection level [L-N] | U_o 1.3 kV |
| Residual voltage [L-N] @ 1 kA | U_{res} 0,7 kV |
| Residual voltage [L-N] @ 5 kA | U_{res} 0,8 kV |
| Max. mains-side overcurrent protection | 160 A gL/gG |
| Short-circuit withstand for max. mains-side overcurrent protection | 50 kA eff |
| Operating temperature range | T_u -40 - +80 °C |
| Protection rating | IP20 |
| Approvals | UL, KEMA, ÖVE, VDE |
| FM contacts | Changeover |
| Switching power AC | 230 V; 0,5 A |
| Switching power DC | 230 V; 0,1 A / 75 V; 0,5 A |
| Connection cross-section, FM terminals | 0,5 - 1,5 mm ² |
| Connection cross-section, FM terminals | 21 - 16 AWG |
| Conductor cross-section, flexible (fine-wire) | 1,5 - 35 mm ² |
| Conductor cross-section, rigid (single wire/multi-wire) | 1,5 - 35 mm ² |
| Conductor cross-section, flexible (fine-wire) | 16 - 2 AWG |
| Conductor cross-section, rigid (single wire/multi-wire) | 16 - 2 AWG |



Combination arrester V50, 3-pole + NPE 280 V

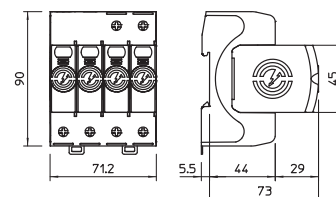

| Type | Max. continuous voltage AC V | Pole version | Protection rating | Pack Piece | Weight kg/100 pc. | Item no. |
|---------------|------------------------------|--------------|-------------------|------------|-------------------|----------|
| V50-3+NPE-280 | 280 | 3+N/PE | IP20 | 1 | 58.800 | 5093526 |

Lightning current combination arrester, type 1+2

- For lightning current equipotential bonding to VDE 0185-305 (IEC 62305)
- Lightning current arresting capacity of 12.5 kA (10/350) per pole and up to 50 kA (10/350) in total
- Modular, plug-in arrester with cut-off unit and visual status display
- Locking mechanism with vibration protection and voltage keying
- Plastic to UL 94 V-0
- The remote signalling (FS) variants have a potential-free change-over contact for remote signalling

Application: Lightning current equipotential bonding for buildings of class III and IV.

| V50-3+NPE-280 | |
|--|--------------------------|
| SPD to EN 61643-11 | Type 1+2 |
| SPD to IEC 61643-11 | Class I+II |
| SPD to UL 1449 | Type 4 |
| Nominal voltage AC (50/60 Hz) | U_n 230 V |
| Maximum continuous voltage AC | U_c 280 V |
| Nominal discharge current (8/20 μ s) | $I_n / L-N$ 30 kA |
| Maximum discharge current (8/20 μ s) | I_{max} 50 kA |
| Lightning surge current (10/350 μ s) | I_{limp} 12.5 kA |
| Lightning surge current (10/350) | I_{total} 50 kA |
| Arrester surge current (8/20 μ s) [total] | I_{total} 80 kA |
| Protection level [L-N] | U_p 1.3 kV |
| Combined voltage protection level [L-PE] | $U_{p/L-PE}$ 2.5 kV |
| Residual voltage [L-N] @ 1 kA | U_{res} 0,7 kV |
| Residual voltage [L-N] @ 5 kA | U_{res} 0,8 kV |
| Max. mains-side overcurrent protection | 160 A gL/gG |
| Short-circuit withstand for max. mains-side overcurrent protection | 50 kA eff |
| Operating temperature range | T_u -40 - +80 °C |
| Protection rating | IP20 |
| Approvals | UL, KEMA, ÖVE, VDE |
| Conductor cross-section, flexible (fine-wire) | 1.5 - 35 mm ² |
| Conductor cross-section, rigid (single wire/multi-wire) | 1.5 - 35 mm ² |
| Conductor cross-section, flexible (fine-wire) | 16 - 2 AWG |
| Conductor cross-section, rigid (single wire/multi-wire) | 16 - 2 AWG |

Connection options

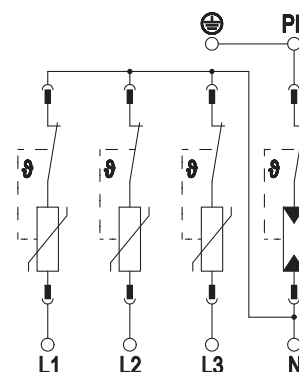



Combination arrester V50, 3-pole + NPE with FS 280 V

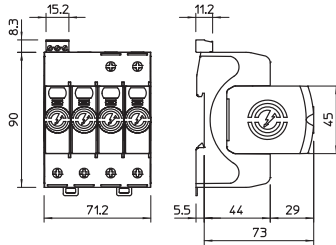

Lightning current combination arrester, type 1+2

- For lightning current equipotential bonding to VDE 0185-305 (IEC 62305)
- Lightning current arresting capacity of 12.5 kA (10/350) per pole and up to 50 kA (10/350) in total
- Modular, plug-in arrester with cut-off unit and visual status display
- Locking mechanism with vibration protection and voltage keying
- Plastic to UL 94 V-0
- The remote signalling (FS) variants have a potential-free changeover contact for remote signalling

Application: Lightning current equipotential bonding for buildings of class III and IV.

| Type | Max. continuous voltage AC V | Pole version | Protection rating | Pack Piece | Weight kg/100 pc. | Item no. |
|------------------|------------------------------|--------------|-------------------|------------|-------------------|----------|
| V50-3+NPE+FS-280 | 280 | 3+N/PE | IP20 | 1 | 59.300 | 5093533 |

Connection options

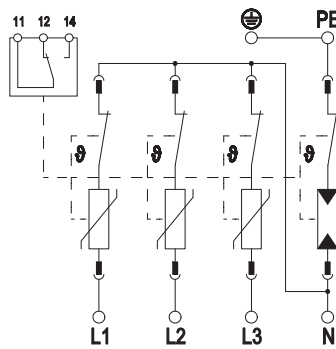

V50-3+NPE+FS-280

| | |
|--|----------------------------|
| SPD to EN 61643-11 | Type 1+2 |
| SPD to IEC 61643-11 | Class II-II |
| SPD to UL 1449 | Type 4 |
| Nominal voltage AC (50/60 Hz) | U_n 230 V |
| Maximum continuous voltage AC | U_c 280 V |
| Nominal discharge current (8/20 μ s) | $I_n / L-N$ 30 kA |
| Maximum discharge current (8/20 μ s) | I_{max} 50 kA |
| Lightning surge current (10/350 μ s) | I_{imp} 12.5 kA |
| Lightning surge current (10/350) | I_{total} 50 kA |
| Arrester surge current (8/20 μ s) [total] | I_{total} 80 kA |
| Protection level [L-N] | U_d 1.3 kV |
| Combined voltage protection level [L-PE] | $U_{d/L-PE}$ 2.5 kV |
| Residual voltage [L-N] @ 1 kA | U_{res} 0,7 kV |
| Residual voltage [L-N] @ 5 kA | U_{res} 0,8 kV |
| Max. mains-side overcurrent protection | 160 A gL/gG |
| Short-circuit withstand for max. mains-side overcurrent protection | 50 kA eff |
| Operating temperature range | T_u -40 - +80 °C |
| Protection rating | IP20 |
| Approvals | UL, KEMA, ÖVE, VDE |
| FM contacts | Changeover |
| Switching power AC | 230 V; 0,5 A |
| Switching power DC | 230 V; 0,1 A / 75 V; 0,5 A |
| Connection cross-section, FM terminals | 0,5 - 1,5 mm ² |
| Connection cross-section, FM terminals | 21 - 16 AWG |
| Conductor cross-section, flexible (fine-wire) | 1.5 - 35 mm ² |
| Conductor cross-section, rigid (single wire/multi-wire) | 1.5 - 35 mm ² |
| Conductor cross-section, flexible (fine-wire) | 16 - 2 AWG |
| Conductor cross-section, rigid (single wire/multi-wire) | 16 - 2 AWG |



Combination arrester V50, 4-pole 280 V

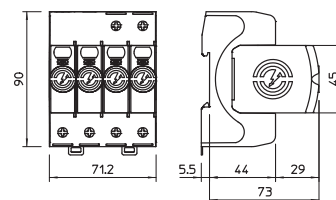

| Type | Max. continuous voltage AC V | Pole version | Protection rating | Pack Piece | Weight kg/100 pc. | Item no. |
|-----------|------------------------------|--------------|-------------------|------------|-------------------|----------|
| V50-4-280 | 280 | 4 | IP20 | 1 | 61.000 | 5093513 |

Lightning current combination arrester, type 1+2

- For lightning current equipotential bonding to VDE 0185-305 (IEC 62305)
- Lightning current arresting capacity of 12.5 kA (10/350) per pole and up to 50 kA (10/350) in total
- Modular, plug-in arrester with cut-off unit and visual status display
- Locking mechanism with vibration protection and voltage keying
- Plastic to UL 94 V-0
- The remote signalling (FS) variants have a potential-free change-over contact for remote signalling

Application: Lightning current equipotential bonding for buildings of class III and IV.

| V50-4-280 | |
|--|--------------------------|
| SPD to EN 61643-11 | Type 1+2 |
| SPD to IEC 61643-11 | Class I+II |
| SPD to UL 1449 | Type 4 |
| Nominal voltage AC (50/60 Hz) | U_n 230 V |
| Maximum continuous voltage AC | U_c 280 V |
| Nominal discharge current (8/20 μ s) | $I_n / L-N$ 30 kA |
| Maximum discharge current (8/20 μ s) | I_{max} 50 kA |
| Lightning surge current (10/350 μ s) | I_{limp} 12.5 kA |
| Lightning surge current (10/350) | I_{total} 50 kA |
| Arrester surge current (8/20 μ s) [total] | I_{total} 160 kA |
| Protection level [L-N] | U_p 1.3 kV |
| Residual voltage [L-N] @ 1 kA | U_{res} 0,7 kV |
| Residual voltage [L-N] @ 5 kA | U_{res} 0,8 kV |
| Max. mains-side overcurrent protection | 160 A gL/gG |
| Short-circuit withstand for max. mains-side overcurrent protection | 50 kA eff |
| Operating temperature range | T_u -40 - +80 °C |
| Protection rating | IP20 |
| Approvals | UL, KEMA, ÖVE, VDE |
| Conductor cross-section, flexible (fine-wire) | 1.5 - 35 mm ² |
| Conductor cross-section, rigid (single wire/multi-wire) | 1.5 - 35 mm ² |
| Conductor cross-section, flexible (fine-wire) | 16 - 2 AWG |
| Conductor cross-section, rigid (single wire/multi-wire) | 16 - 2 AWG |

Connection options

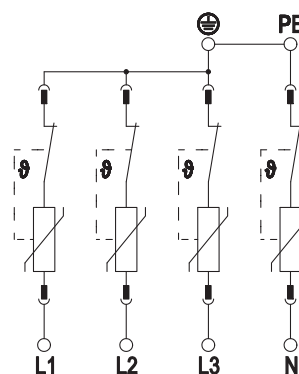



Combination arrester V50, 4-pole with FS 280 V

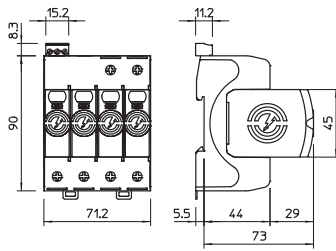

Lightning current combination arrester, type 1+2

- For lightning current equipotential bonding to VDE 0185-305 (IEC 62305)
- Lightning current arresting capacity of 12.5 kA (10/350) per pole and up to 50 kA (10/350) in total
- Modular, plug-in arrester with cut-off unit and visual status display
- Locking mechanism with vibration protection and voltage keying
- Plastic to UL 94 V-0
- The remote signalling (FS) variants have a potential-free changeover contact for remote signalling

Application: Lightning current equipotential bonding for buildings of class III and IV.

| Type | Max. continuous voltage AC V | Pole version | Protection rating | Pack Piece | Weight kg/100 pc. | Item no. |
|---------------------|------------------------------|--------------|-------------------|------------|-------------------|----------------|
| V50-4+FS-280 | 280 | 4 | IP20 | 1 | 61.500 | 5093518 |

Connection options

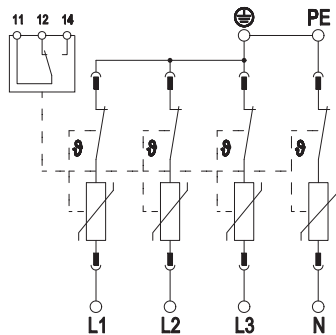

V50-4+FS-280

| | |
|--|----------------------------|
| SPD to EN 61643-11 | Type 1+2 |
| SPD to IEC 61643-11 | Class I+II |
| SPD to UL 1449 | Type 4 |
| Nominal voltage AC (50/60 Hz) | U_n 230 V |
| Maximum continuous voltage AC | U_c 280 V |
| Nominal discharge current (8/20 μ s) | $I_n / L-N$ 30 kA |
| Maximum discharge current (8/20 μ s) | I_{max} 50 kA |
| Lightning surge current (10/350 μ s) | I_{imp} 12.5 kA |
| Lightning surge current (10/350) | I_{total} 50 kA |
| Arrester surge current (8/20 μ s) [total] | I_{total} 160 kA |
| Protection level [L-N] | U_o 1.3 kV |
| Residual voltage [L-N] @ 1 kA | U_{res} 0,7 kV |
| Residual voltage [L-N] @ 5 kA | U_{res} 0,8 kV |
| Max. mains-side overcurrent protection | 160 A gL/gG |
| Short-circuit withstand for max. mains-side overcurrent protection | 50 kA eff |
| Operating temperature range | T_u -40 - +80 °C |
| Protection rating | IP20 |
| Approvals | UL, KEMA, ÖVE, VDE |
| FM contacts | Changeover |
| Switching power AC | 230 V; 0,5 A |
| Switching power DC | 230 V; 0,1 A / 75 V; 0,5 A |
| Connection cross-section, FM terminals | 0,5 - 1,5 mm ² |
| Connection cross-section, FM terminals | 21 - 16 AWG |
| Conductor cross-section, flexible (fine-wire) | 1,5 - 35 mm ² |
| Conductor cross-section, rigid (single wire/multi-wire) | 1,5 - 35 mm ² |
| Conductor cross-section, flexible (fine-wire) | 16 - 2 AWG |
| Conductor cross-section, rigid (single wire/multi-wire) | 16 - 2 AWG |



Lightning current and surge arrester MCF 35

Surge protective device for energy technology, arrester, type 1 (industry)



- Lightning current and surge arresters
- High arresting capacity up to 35 kA (10/350) per pin
- Arresters for buildings with lightning protection system
- Visual status display
- With remote signalling
- Simple standard DIN rail mounting
- Labelled connections
- Usable in systems with lightning protection class I-V

The MCF lightning current arresters meet the type 1 requirement class according to IEC 61643-11. These devices protect low-voltage and consumer systems against any type of surges. Several benefits are achieved through the use of the voltage-limiting carbon spark gap. A short response time, a

low protection level and high current leakage capability with long service life. In addition, the devices do not produce any line follow current. If circumstances are uncertain and there is a risk of fire from overloads, the cut-off unit disconnects the arrester safely from the mains.

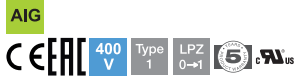

Lightning arrester MCF 35, 400/690 V, 1-pole with IR

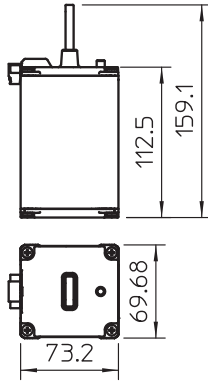

Lightning arrester type 1

- For lightning protection equipotential bonding to DIN EN 62305 (IEC 62305)
- Lightning current arresting capacity 35 kA (10/350) per pole
- Follow current extinguishing 50 kA_{eff}, arrester back-up fuse up to 400 A gL/gG
- Encapsulated, non-extinguishing spark gap arrester for use in distributor housings
- Cut-off unit with visual indicator
- Remote signalling with potential-free changeover contact

Application: Without exception for 400/690 V network systems

| Type | Highest continuous voltage V | Version | Pack Piece | Weight kg/100 pc. | Item no. |
|-----------------|------------------------------|---------|------------|-------------------|----------|
| MCF 35-1+FS-440 | 440 | 1-pole | 1 | 98.000 | 5096974 |

Connection options



| MCF 35-1+FS-440 | |
|--|--------------------------|
| Nominal voltage | U_N 400 V |
| Max. continuous operating voltage | U_C 440 V |
| SPD to EN 61643-11 | Type 1 |
| SPD to IEC 61643-11 | Class I |
| Impulse discharge current (10/350) | I_{imp} 35 kA |
| Nominal discharge current (8/20) | I_n 35 kA |
| Protection level | U_p 2,5 kV |
| Follow current quenching capacity leff | $I_{fi\,eff}$ 50 kA |
| Maximum back-up fuse | 400 A |
| Protection rating | IP20 |
| Response time | t_A < 100 ns |
| Temperature range | ϑ -40 - +85 °C |



Lightning arrester MCF 35, 400/690 V, 3-pole with IR

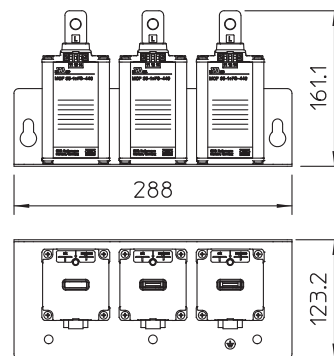
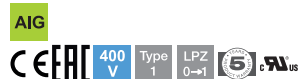

| Type | Highest continuous voltage V | Version | Pack Piece | Weight kg/100 pc. | Item no. |
|------------------|------------------------------|---------|------------|-------------------|----------|
| MCF 35-P3+FS-440 | 440 | 3-pole | 1 | 400.000 | 5096976 |

- Lightning arrester type 1
- Fully assembled 3-pole connection unit
 - For lightning protection equipotential bonding according to DIN EN 62305 (IEC 62305)
 - Lightning current arresting capacity 35 kA (10/350) per pole
 - Line following current quenching 50 kA_{eff}, arrester back-up fuse up to 400 A gL/gG
 - Encapsulated, non-extinguishing spark gap arrester for use in distributor housings
 - Cut-off unit with visual indicator
 - Remote signalling with potential-free changeover contact
 - For finished mounting on busbars and walls
- Application: Without exception for 400/690 V power systems

| MCF 35-P3+FS-440 | |
|---|-----------------------|
| Nominal voltage | U_N 400 V |
| Max. continuous operating voltage | U_C 440 V |
| SPD to EN 61643-11 | Type 1 |
| SPD to IEC 61643-11 | Class I |
| Impulse discharge current (10/350) | I_{imp} 35 kA |
| Nominal discharge current (8/20) | I_n 35 kA |
| Protection level | U_p 2,5 kV |
| Follow current quenching capacity $I_{fi\ eff}$ | 50 kA |
| Maximum back-up fuse | 400 A |
| Protection rating | IP20 |
| Response time | t_A < 100 ns |
| Temperature range | θ -40 - +85 °C |

Connection options

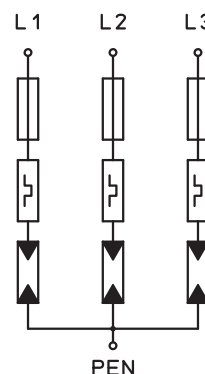

Surge arrester V20

Surge protection energy technology, type 2 arrester



Schutzinstallationen Überspannungsschutz und Explosionsschutz / en / 2021/06/25 09:52:32 (LLExpert_02926) / 2021/06/25

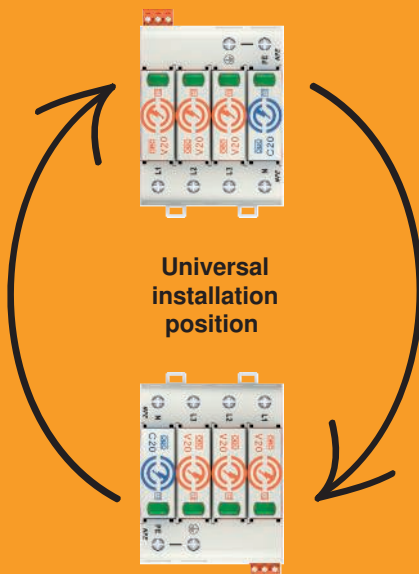

- Type 2 SPD: $I_n = 20 \text{ kA (L-N) / 40 \text{ kA (N-PE)}$, up to 60 kA
- Protection level: $< 1.5 \text{ kV}$, usable in coordination with type 3 SPD
- Exceeds the increased requirements according to VDE 0100-443
- Quality according to EN 61643-11 certified by an external testing institute
- Universally usable for industry, offices, commercial and residential buildings
- Locking function with vibration protection
- System protection up to 160 A usable without separate fusing
- Can be installed universally through 90° labelling
- Voltage variants: 75 V, 150 V, 280 V, 320 V, 385 V, 440 V, 550 V
- Optional remote signalling, potential-free changeover contact
- Variants in one to four-pole versions
- Operating instructions always available online via QR code

Surge arrester V20, 1-pole, 280 V

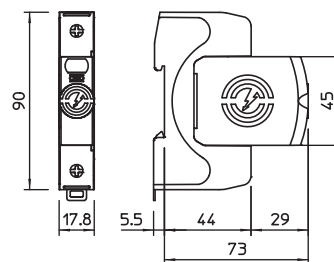
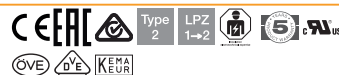

| Type | Max. continuous voltage AC V | Pole version | Protection rating | Pack Piece | Weight kg/100 pc. | Item no. |
|-----------|------------------------------|--------------|-------------------|------------|-------------------|----------|
| V20-1-280 | 280 | 1 | IP20 | 1 | 12.900 | 5095161 |

Surge arrester, type 2

- For surge voltage protection equipotential bonding to VDE 0100-443 (IEC 60364-4-44)
- Discharge capacity to 40 kA (8/20) per pole through high-performance varistors
- Modular connectable arrester with cut-off unit and visual status display
- Locking mechanism with vibration protection and voltage keying
- Plastic to UL 94 V-0
- The remote signalling variants (FS) have a potential-free changeover contact for remote signalling

Application: Equipotential bonding in main and sub-distributions.

V20-1-280

| | |
|--|--------------------------|
| SPD to EN 61643-11 | Type 2 |
| SPD to IEC 61643-11 | Class II |
| SPD to UL 1449 | Type 4 |
| Nominal voltage AC (50/60 Hz) | U_n 230 V |
| Maximum continuous voltage AC | U_c 280 V |
| Nominal discharge current (8/20 μ s) | $I_n / L-N$ 20 kA |
| Maximum discharge current (8/20 μ s) | I_{max} 40 kA |
| Arrester surge current (8/20 μ s) [total] | I_{total} 40 kA |
| Protection level [L-N] | U_p 1.3 kV |
| Residual voltage [L-N] @ 1 kA | U_{res} 0,8 kV |
| Residual voltage [L-N] @ 5 kA | U_{res} 1,0 kV |
| Max. mains-side overcurrent protection | 160 A gL/gG |
| Short-circuit withstand for max. mains-side overcurrent protection | 50 kA eff |
| Operating temperature range | T_u -40 - +80 °C |
| Protection rating | IP20 |
| Approvals | UL, ÖVE, VDE, KEMA |
| Conductor cross-section, flexible (fine-wire) | 1.5 - 35 mm ² |
| Conductor cross-section, rigid (single wire/multi-wire) | 1.5 - 35 mm ² |
| Conductor cross-section, flexible (fine-wire) | 16 - 2 AWG |
| Conductor cross-section, rigid (single wire/multi-wire) | 16 - 2 AWG |

Connection options



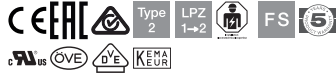

Surge arrester V20, 1-pole with remote signaling, 280 V

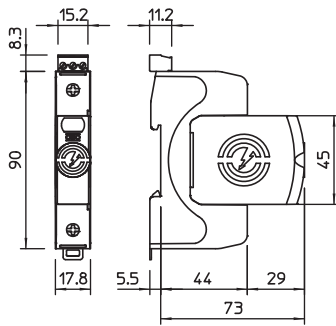

Surge arrester, type 2

- For surge voltage protection equipotential bonding to VDE 0100-443 (IEC 60364-4-44)
- Discharge capacity to 40 kA (8/20) per pole through high-performance varistors
- Modular connectable arrester with cut-off unit and visual status display
- Locking mechanism with vibration protection and voltage keying
- Plastic to UL 94 V-0
- The remote signalling variants (FS) have a potential-free changeover contact for remote signalling

Application: Equipotential bonding in main and sub-distributions.

| Type | Max. continuous voltage AC V | Pole version | Protection rating | Pack Piece | Weight kg/100 pc. | Item no. |
|--------------|------------------------------|--------------|-------------------|------------|-------------------|----------|
| V20-1+FS-280 | 280 | 1 | IP20 | 1 | 13.100 | 5095281 |

Connection options

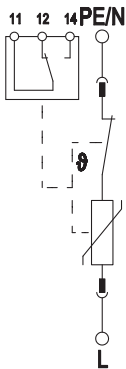

| V20-1+FS-280 | |
|--|----------------------------|
| SPD to EN 61643-11 | Type 2 |
| SPD to IEC 61643-11 | Class II |
| SPD to UL 1449 | Type 4 |
| Nominal voltage AC (50/60 Hz) | U_n 230 V |
| Maximum continuous voltage AC | U_c 280 V |
| Nominal discharge current (8/20 μ s) | $I_n / L-N$ 20 kA |
| Maximum discharge current (8/20 μ s) | I_{max} 40 kA |
| Arrester surge current (8/20 μ s) [total] | I_{total} 40 kA |
| Protection level [L-N] | U_b 1.3 kV |
| Residual voltage [L-N] @ 1 kA | U_{res} 0,8 kV |
| Residual voltage [L-N] @ 5 kA | U_{res} 1,0 kV |
| Max. mains-side overcurrent protection | 160 A gL/gG |
| Short-circuit withstand for max. mains-side overcurrent protection | 50 kA eff |
| Operating temperature range | T_u -40 - +80 °C |
| Protection rating | IP20 |
| Approvals | UL, ÖVE, VDE, KEMA |
| FM contacts | Changeover |
| Switching power AC | 230 V; 0,5 A |
| Switching power DC | 230 V; 0,1 A / 75 V; 0,5 A |
| Connection cross-section, FM terminals | 0,5 - 1,5 mm ² |
| Connection cross-section, FM terminals | 21 - 16 AWG |
| Conductor cross-section, flexible (fine-wire) | 1,5 - 35 mm ² |
| Conductor cross-section, rigid (single wire/multi-wire) | 1,5 - 35 mm ² |
| Conductor cross-section, flexible (fine-wire) | 16 - 2 AWG |
| Conductor cross-section, rigid (single wire/multi-wire) | 16 - 2 AWG |



Surge arrester V20, 1-pole + NPE, 280 V

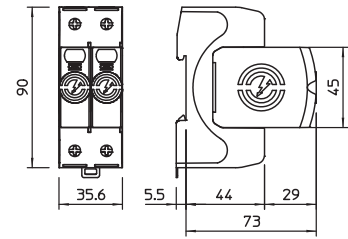

| Type | Max. continuous voltage AC V | Pole version | Protection rating | Pack Piece | Weight kg/100 pc. | Item no. |
|---------------|------------------------------|--------------|-------------------|------------|-------------------|----------|
| V20-1+NPE-280 | 280 | 1+N/PE | IP20 | 1 | 24.300 | 5095251 |

Surge arrester, type 2

- For surge voltage protection equipotential bonding to VDE 0100-443 (IEC 60364-4-44)
- Discharge capacity to 40 kA (8/20) per pole through high-performance varistors
- Modular connectable arrester with cut-off unit and visual status display
- Locking mechanism with vibration protection and voltage keying
- Plastic to UL 94 V-0
- The remote signalling variants (FS) have a potential-free changeover contact for remote signalling

Application: Equipotential bonding in main and sub-distributions.

V20-1+NPE-280

| | |
|--|--------------------------|
| SPD to EN 61643-11 | Type 2 |
| SPD to IEC 61643-11 | Class II |
| SPD to UL 1449 | Type 4 |
| Nominal voltage AC (50/60 Hz) | U_n 230 V |
| Maximum continuous voltage AC | U_c 280 V |
| Nominal discharge current (8/20 μ s) | $I_n / L-N$ 20 kA |
| Maximum discharge current (8/20 μ s) | I_{max} 40 kA |
| Arrester surge current (8/20 μ s) [total] | I_{total} 60 kA |
| Protection level [L-N] | U_p 1.3 kV |
| Combined voltage protection level [L-PE] | $U_{p/L-PE}$ 1.5 kV |
| Residual voltage [L-N] @ 1 kA | U_{res} 0,8 kV |
| Residual voltage [L-N] @ 5 kA | U_{res} 1,0 kV |
| Max. mains-side overcurrent protection | 160 A gL/gG |
| Short-circuit withstand for max. mains-side overcurrent protection | 50 kA eff |
| Operating temperature range | T_u -40 - +80 °C |
| Protection rating | IP20 |
| Approvals | UL, ÖVE, VDE, KEMA |
| Conductor cross-section, flexible (fine-wire) | 1.5 - 35 mm ² |
| Conductor cross-section, rigid (single wire/multi-wire) | 1.5 - 35 mm ² |
| Conductor cross-section, flexible (fine-wire) | 16 - 2 AWG |
| Conductor cross-section, rigid (single wire/multi-wire) | 16 - 2 AWG |

Connection options

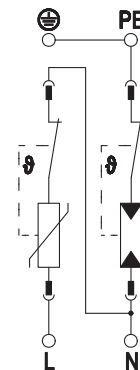

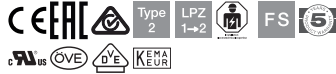

Surge arrester V20, 1-pole + NPE and remote signalling, 280 V

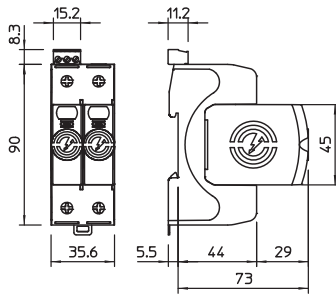

Surge arrester, type 2

- For surge voltage protection equipotential bonding to VDE 0100-443 (IEC 60364-4-44)
- Discharge capacity to 40 kA (8/20) per pole through high-performance varistors
- Modular connectable arrester with cut-off unit and visual status display
- Locking mechanism with vibration protection and voltage keying
- Plastic to UL 94 V-0
- The remote signalling variants (FS) have a potential-free changeover contact for remote signalling

Application: Equipotential bonding in main and sub-distributions.

| Type | Max. continuous voltage AC V | Pole version | Protection rating | Pack Piece | Weight kg/100 pc. | Item no. |
|------------------|------------------------------|--------------|-------------------|------------|-------------------|----------|
| V20-1+NPE+FS-280 | 280 | 1+N/PE | IP20 | 1 | 24.600 | 5095331 |

Connection options

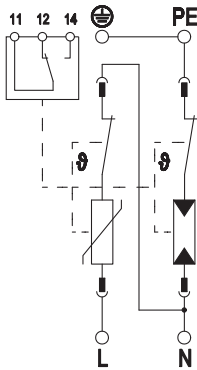

| V20-1+NPE+FS-280 | |
|--|----------------------------|
| SPD to EN 61643-11 | Type 2 |
| SPD to IEC 61643-11 | Class II |
| SPD to UL 1449 | Type 4 |
| Nominal voltage AC (50/60 Hz) | U_n 230 V |
| Maximum continuous voltage AC | U_c 280 V |
| Nominal discharge current (8/20 μ s) | $I_n / L-N$ 20 kA |
| Maximum discharge current (8/20 μ s) | I_{max} 40 kA |
| Arrester surge current (8/20 μ s) [total] | I_{total} 60 kA |
| Protection level [L-N] | U_b 1.3 kV |
| Combined voltage protection level [L-PE] | $U_{D / L-PE}$ 1.5 kV |
| Residual voltage [L-N] @ 1 kA | U_{res} 0,8 kV |
| Residual voltage [L-N] @ 5 kA | U_{res} 1,0 kV |
| Max. mains-side overcurrent protection | 160 A gL/gG |
| Short-circuit withstand for max. mains-side overcurrent protection | 50 kA eff |
| Operating temperature range | T_u -40 - +80 °C |
| Protection rating | IP20 |
| Approvals | UL, ÖVE, VDE, KEMA |
| FM contacts | Changeover |
| Switching power AC | 230 V; 0,5 A |
| Switching power DC | 230 V; 0,1 A / 75 V; 0,5 A |
| Connection cross-section, FM terminals | 0,5 - 1,5 mm ² |
| Connection cross-section, FM terminals | 21 - 16 AWG |
| Conductor cross-section, flexible (fine-wire) | 1,5 - 35 mm ² |
| Conductor cross-section, rigid (single wire/multi-wire) | 1,5 - 35 mm ² |
| Conductor cross-section, flexible (fine-wire) | 16 - 2 AWG |
| Conductor cross-section, rigid (single wire/multi-wire) | 16 - 2 AWG |



Surge arrester V20, 2-pole, 280 V

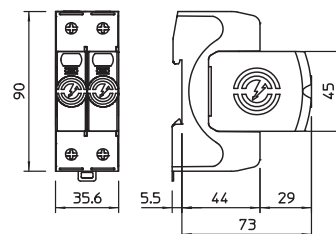
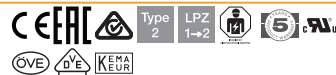

| Type | Max. continuous voltage AC V | Pole version | Protection rating | Pack Piece | Weight kg/100 pc. | Item no. |
|-----------|------------------------------|--------------|-------------------|------------|-------------------|----------|
| V20-2-280 | 280 | 2 | IP20 | 1 | 25.600 | 5095162 |

Surge arrester, type 2

- For surge voltage protection equipotential bonding to VDE 0100-443 (IEC 60364-4-44)
- Discharge capacity to 40 kA (8/20) per pole through high-performance varistors
- Modular connectable arrester with cut-off unit and visual status display
- Locking mechanism with vibration protection and voltage keying
- Plastic to UL 94 V-0
- The remote signalling variants (FS) have a potential-free changeover contact for remote signalling

Application: Equipotential bonding in main and sub-distributions.

V20-2-280

| | |
|--|--------------------------|
| SPD to EN 61643-11 | Type 2 |
| SPD to IEC 61643-11 | Class II |
| SPD to UL 1449 | Type 4 |
| Nominal voltage AC (50/60 Hz) | U_n 230 V |
| Maximum continuous voltage AC | U_c 280 V |
| Nominal discharge current (8/20 μ s) | $I_n / L-N$ 20 kA |
| Maximum discharge current (8/20 μ s) | I_{max} 40 kA |
| Arrester surge current (8/20 μ s) [total] | I_{total} 80 kA |
| Protection level [L-N] | U_p 1.3 kV |
| Residual voltage [L-N] @ 1 kA | U_{res} 0,8 kV |
| Residual voltage [L-N] @ 5 kA | U_{res} 1,0 kV |
| Max. mains-side overcurrent protection | 160 A gL/gG |
| Short-circuit withstand for max. mains-side overcurrent protection | 50 kA eff |
| Operating temperature range | T_u -40 - +80 °C |
| Protection rating | IP20 |
| Approvals | UL, ÖVE, VDE, KEMA |
| Conductor cross-section, flexible (fine-wire) | 1.5 - 35 mm ² |
| Conductor cross-section, rigid (single wire/multi-wire) | 1.5 - 35 mm ² |
| Conductor cross-section, flexible (fine-wire) | 16 - 2 AWG |
| Conductor cross-section, rigid (single wire/multi-wire) | 16 - 2 AWG |

Connection options

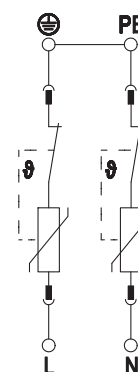

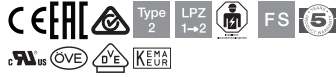

Surge arrester V20, 2-pole with remote signaling, 280 V

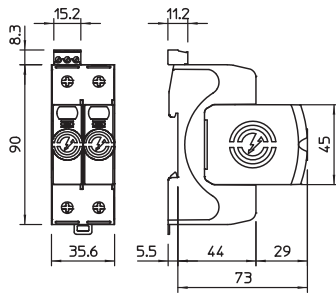

Surge arrester, type 2

- For surge voltage protection equipotential bonding to VDE 0100-443 (IEC 60364-4-44)
- Discharge capacity to 40 kA (8/20) per pole through high-performance varistors
- Modular connectable arrester with cut-off unit and visual status display
- Locking mechanism with vibration protection and voltage keying
- Plastic to UL 94 V-0
- The remote signalling variants (FS) have a potential-free changeover contact for remote signalling

Application: Equipotential bonding in main and sub-distributions.

| Type | Max. continuous voltage AC V | Pole version | Protection rating | Pack Piece | Weight kg/100 pc. | Item no. |
|--------------|------------------------------|--------------|-------------------|------------|-------------------|----------|
| V20-2+FS-280 | 280 | 2 | IP20 | 1 | 25.900 | 5095282 |

Connection options

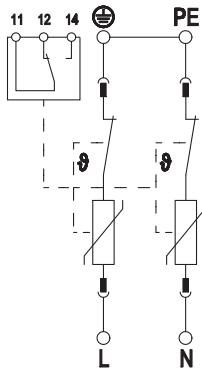

| V20-2+FS-280 | |
|--|----------------------------|
| SPD to EN 61643-11 | Type 2 |
| SPD to IEC 61643-11 | Class II |
| SPD to UL 1449 | Type 4 |
| Nominal voltage AC (50/60 Hz) | U_n 230 V |
| Maximum continuous voltage AC | U_c 280 V |
| Nominal discharge current (8/20 μ s) | $I_n / L-N$ 20 kA |
| Maximum discharge current (8/20 μ s) | I_{max} 40 kA |
| Arrester surge current (8/20 μ s) [total] | I_{total} 80 kA |
| Protection level [L-N] | U_b 1.3 kV |
| Residual voltage [L-N] @ 1 kA | U_{res} 0,8 kV |
| Residual voltage [L-N] @ 5 kA | U_{res} 1,0 kV |
| Max. mains-side overcurrent protection | 160 A gL/gG |
| Short-circuit withstand for max. mains-side overcurrent protection | 50 kA eff |
| Operating temperature range | T_u -40 - +80 °C |
| Protection rating | IP20 |
| Approvals | UL, ÖVE, VDE, KEMA |
| FM contacts | Changeover |
| Switching power AC | 230 V; 0,5 A |
| Switching power DC | 230 V; 0,1 A / 75 V; 0,5 A |
| Connection cross-section, FM terminals | 0,5 - 1,5 mm ² |
| Connection cross-section, FM terminals | 21 - 16 AWG |
| Conductor cross-section, flexible (fine-wire) | 1,5 - 35 mm ² |
| Conductor cross-section, rigid (single wire/multi-wire) | 1,5 - 35 mm ² |
| Conductor cross-section, flexible (fine-wire) | 16 - 2 AWG |
| Conductor cross-section, rigid (single wire/multi-wire) | 16 - 2 AWG |



Surge arrester V20, 2-pole + NPE, 280 V

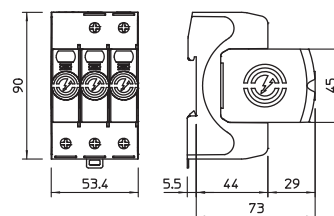
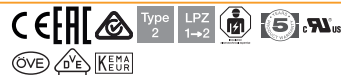

| Type | Max. continuous voltage AC V | Pole version | Protection rating | Pack Piece | Weight kg/100 pc. | Item no. |
|---------------|------------------------------|--------------|-------------------|------------|-------------------|----------|
| V20-2+NPE-280 | 280 | 2+N/PE | IP20 | 1 | 34.600 | 5095252 |

Surge arrester, type 2

- For surge voltage protection equipotential bonding to VDE 0100-443 (IEC 60364-4-44)
- Discharge capacity to 40 kA (8/20) per pole through high-performance varistors
- Modular connectable arrester with cut-off unit and visual status display
- Locking mechanism with vibration protection and voltage keying
- Plastic to UL 94 V-0
- The remote signalling variants (FS) have a potential-free changeover contact for remote signalling

Application: Equipotential bonding in main and sub-distributions.

V20-2+NPE-280

| | |
|--|--------------------------|
| SPD to EN 61643-11 | Type 2 |
| SPD to IEC 61643-11 | Class II |
| SPD to UL 1449 | Type 4 |
| Nominal voltage AC (50/60 Hz) | U_n 230 V |
| Maximum continuous voltage AC | U_c 280 V |
| Nominal discharge current (8/20 μ s) | $I_n / L-N$ 20 kA |
| Maximum discharge current (8/20 μ s) | I_{max} 40 kA |
| Arrester surge current (8/20 μ s) [total] | I_{total} 60 kA |
| Protection level [L-N] | U_p 1.3 kV |
| Combined voltage protection level [L-PE] | $U_{p/L-PE}$ 1.5 kV |
| Residual voltage [L-N] @ 1 kA | U_{res} 0,8 kV |
| Residual voltage [L-N] @ 5 kA | U_{res} 1,0 kV |
| Max. mains-side overcurrent protection | 160 A gL/gG |
| Short-circuit withstand for max. mains-side overcurrent protection | 50 kA eff |
| Operating temperature range | T_u -40 - +80 °C |
| Protection rating | IP20 |
| Approvals | UL, ÖVE, VDE, KEMA |
| Conductor cross-section, flexible (fine-wire) | 1.5 - 35 mm ² |
| Conductor cross-section, rigid (single wire/multi-wire) | 1.5 - 35 mm ² |
| Conductor cross-section, flexible (fine-wire) | 16 - 2 AWG |
| Conductor cross-section, rigid (single wire/multi-wire) | 16 - 2 AWG |

Connection options

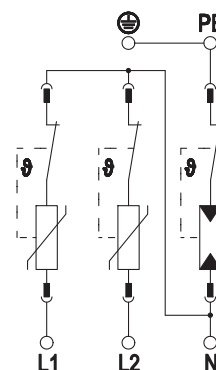

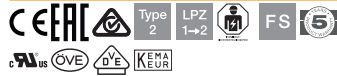

Surge arrester V20, 2-pole + NPE and remote signalling, 280 V

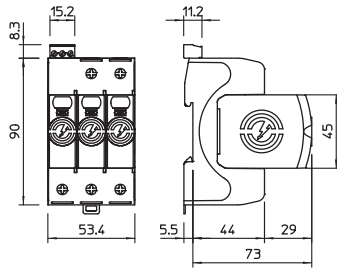

Surge arrester, type 2

- For surge voltage protection equipotential bonding to VDE 0100-443 (IEC 60364-4-44)
- Discharge capacity to 40 kA (8/20) per pole through high-performance varistors
- Modular connectable arrester with cut-off unit and visual status display
- Locking mechanism with vibration protection and voltage keying
- Plastic to UL 94 V-0
- The remote signalling variants (FS) have a potential-free changeover contact for remote signalling

Application: Equipotential bonding in main and sub-distributions.

| Type | Max. continuous voltage AC V | Pole version | Protection rating | Pack Piece | Weight kg/100 pc. | Item no. |
|------------------|------------------------------|--------------|-------------------|------------|-------------------|----------|
| V20-2+NPE+FS-280 | 280 | 2+N/PE | IP20 | 1 | 34.800 | 5095332 |

Connection options

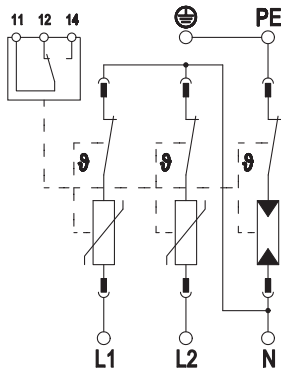

| V20-2+NPE+FS-280 | |
|--|----------------------------|
| SPD to EN 61643-11 | Type 2 |
| SPD to IEC 61643-11 | Class II |
| SPD to UL 1449 | Type 4 |
| Nominal voltage AC (50/60 Hz) | U_n 230 V |
| Maximum continuous voltage AC | U_c 280 V |
| Nominal discharge current (8/20 μ s) | $I_n / L-N$ 20 kA |
| Maximum discharge current (8/20 μ s) | I_{max} 40 kA |
| Arrester surge current (8/20 μ s) [total] | I_{total} 60 kA |
| Protection level [L-N] | U_b 1.3 kV |
| Combined voltage protection level [L-PE] | $U_{D / L-PE}$ 1.5 kV |
| Residual voltage [L-N] @ 1 kA | U_{res} 0,8 kV |
| Residual voltage [L-N] @ 5 kA | U_{res} 1,0 kV |
| Max. mains-side overcurrent protection | 160 A gL/gG |
| Short-circuit withstand for max. mains-side overcurrent protection | 50 kA eff |
| Operating temperature range | T_u -40 - +80 °C |
| Protection rating | IP20 |
| Approvals | UL, ÖVE, VDE, KEMA |
| FM contacts | Changeover |
| Switching power AC | 230 V; 0,5 A |
| Switching power DC | 230 V; 0,1 A / 75 V; 0,5 A |
| Connection cross-section, FM terminals | 0,5 - 1,5 mm ² |
| Connection cross-section, FM terminals | 21 - 16 AWG |
| Conductor cross-section, flexible (fine-wire) | 1,5 - 35 mm ² |
| Conductor cross-section, rigid (single wire/multi-wire) | 1,5 - 35 mm ² |
| Conductor cross-section, flexible (fine-wire) | 16 - 2 AWG |
| Conductor cross-section, rigid (single wire/multi-wire) | 16 - 2 AWG |



Surge arrester V20, 3-pole, 280 V

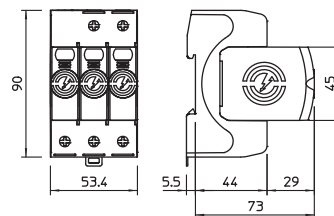
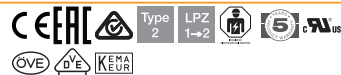

| Type | Max. continuous voltage AC V | Pole version | Protection rating | Pack Piece | Weight kg/100 pc. | Item no. |
|-----------|------------------------------|--------------|-------------------|------------|-------------------|----------|
| V20-3-280 | 280 | 3 | IP20 | 1 | 36.000 | 5095163 |

Surge arrester, type 2

- For surge voltage protection equipotential bonding to VDE 0100-443 (IEC 60364-4-44)
- Discharge capacity to 40 kA (8/20) per pole through high-performance varistors
- Modular connectable arrester with cut-off unit and visual status display
- Locking mechanism with vibration protection and voltage keying
- Plastic to UL 94 V-0
- The remote signalling variants (FS) have a potential-free changeover contact for remote signalling

Application: Equipotential bonding in main and sub-distributions.

V20-3-280

| | |
|--|--------------------------|
| SPD to EN 61643-11 | Type 2 |
| SPD to IEC 61643-11 | Class II |
| SPD to UL 1449 | Type 4 |
| Nominal voltage AC (50/60 Hz) | U_n 230 V |
| Maximum continuous voltage AC | U_c 280 V |
| Nominal discharge current (8/20 μ s) | $I_n / L-N$ 20 kA |
| Maximum discharge current (8/20 μ s) | I_{max} 40 kA |
| Arrester surge current (8/20 μ s) [total] | I_{total} 120 kA |
| Protection level [L-N] | U_p 1.3 kV |
| Residual voltage [L-N] @ 1 kA | U_{res} 0,8 kV |
| Residual voltage [L-N] @ 5 kA | U_{res} 1,0 kV |
| Max. mains-side overcurrent protection | 160 A gL/gG |
| Short-circuit withstand for max. mains-side overcurrent protection | 50 kA eff |
| Operating temperature range | T_u -40 - +80 °C |
| Protection rating | IP20 |
| Approvals | UL, ÖVE, VDE, KEMA |
| Conductor cross-section, flexible (fine-wire) | 1.5 - 35 mm ² |
| Conductor cross-section, rigid (single wire/multi-wire) | 1.5 - 35 mm ² |
| Conductor cross-section, flexible (fine-wire) | 16 - 2 AWG |
| Conductor cross-section, rigid (single wire/multi-wire) | 16 - 2 AWG |

Connection options

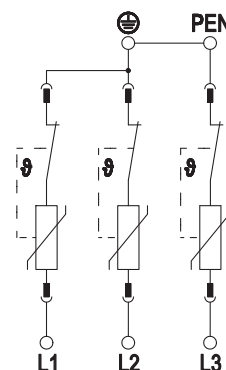

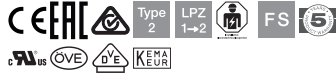

Surge arrester V20, 3-pole with remote signaling, 280 V

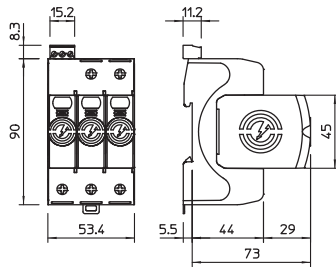

Surge arrester, type 2

- For surge voltage protection equipotential bonding to VDE 0100-443 (IEC 60364-4-44)
- Discharge capacity to 40 kA (8/20) per pole through high-performance varistors
- Modular connectable arrester with cut-off unit and visual status display
- Locking mechanism with vibration protection and voltage keying
- Plastic to UL 94 V-0
- The remote signalling variants (FS) have a potential-free changeover contact for remote signalling

Application: Equipotential bonding in main and sub-distributions.

| Type | Max. continuous voltage AC V | Pole version | Protection rating | Pack Piece | Weight kg/100 pc. | Item no. |
|---------------------|------------------------------|--------------|-------------------|------------|-------------------|----------------|
| V20-3+FS-280 | 280 | 3 | IP20 | 1 | 36.400 | 5095283 |

Connection options

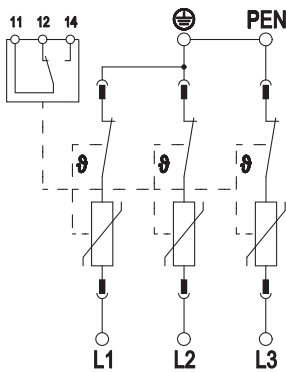

V20-3+FS-280

| | |
|--|----------------------------|
| SPD to EN 61643-11 | Type 2 |
| SPD to IEC 61643-11 | Class II |
| SPD to UL 1449 | Type 4 |
| Nominal voltage AC (50/60 Hz) | U_n 230 V |
| Maximum continuous voltage AC | U_c 280 V |
| Nominal discharge current (8/20 μ s) | $I_n / L-N$ 20 kA |
| Maximum discharge current (8/20 μ s) | I_{max} 40 kA |
| Arrester surge current (8/20 μ s) [total] | I_{total} 120 kA |
| Protection level [L-N] | U_b 1.3 kV |
| Residual voltage [L-N] @ 1 kA | U_{res} 0.8 kV |
| Residual voltage [L-N] @ 5 kA | U_{res} 1.0 kV |
| Max. mains-side overcurrent protection | 160 A gL/gG |
| Short-circuit withstand for max. mains-side overcurrent protection | 50 kA eff |
| Operating temperature range | T_u -40 - +80 °C |
| Protection rating | IP20 |
| Approvals | UL, ÖVE, VDE, KEMA |
| FM contacts | Changeover |
| Switching power AC | 230 V; 0,5 A |
| Switching power DC | 230 V; 0,1 A / 75 V; 0,5 A |
| Connection cross-section, FM terminals | 0,5 - 1,5 mm ² |
| Connection cross-section, FM terminals | 21 - 16 AWG |
| Conductor cross-section, flexible (fine-wire) | 1.5 - 35 mm ² |
| Conductor cross-section, rigid (single wire/multi-wire) | 1.5 - 35 mm ² |
| Conductor cross-section, flexible (fine-wire) | 16 - 2 AWG |
| Conductor cross-section, rigid (single wire/multi-wire) | 16 - 2 AWG |



Surge arrester V20, 3-pole + NPE, 280 V

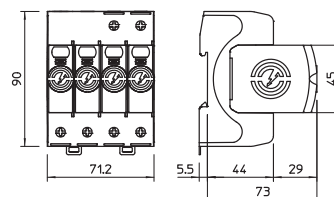
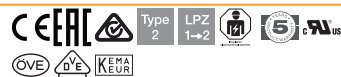

| Type | Max. continuous voltage AC V | Pole version | Protection rating | Pack Piece | Weight kg/100 pc. | Item no. |
|---------------|------------------------------|--------------|-------------------|------------|-------------------|----------|
| V20-3+NPE-280 | 280 | 3+N/PE | IP20 | 1 | 45.800 | 5095253 |

Surge arrester, type 2

- For surge voltage protection equipotential bonding to VDE 0100-443 (IEC 60364-4-44)
- Discharge capacity to 40 kA (8/20) per pole through high-performance varistors
- Modular connectable arrester with cut-off unit and visual status display
- Locking mechanism with vibration protection and voltage keying
- Plastic to UL 94 V-0
- The remote signalling variants (FS) have a potential-free changeover contact for remote signalling

Application: Equipotential bonding in main and sub-distributions.

| V20-3+NPE-280 | |
|--|--------------------------|
| SPD to EN 61643-11 | Type 2 |
| SPD to IEC 61643-11 | Class II |
| SPD to UL 1449 | Type 4 |
| Nominal voltage AC (50/60 Hz) | U_n 230 V |
| Maximum continuous voltage AC | U_c 280 V |
| Nominal discharge current (8/20 μ s) | $I_n / L-N$ 20 kA |
| Maximum discharge current (8/20 μ s) | I_{max} 40 kA |
| Arrester surge current (8/20 μ s) [total] | I_{total} 60 kA |
| Protection level [L-N] | U_p 1.3 kV |
| Combined voltage protection level [L-PE] | $U_{p/L-PE}$ 1.5 kV |
| Residual voltage [L-N] @ 1 kA | U_{res} 0,8 kV |
| Residual voltage [L-N] @ 5 kA | U_{res} 1,0 kV |
| Max. mains-side overcurrent protection | 160 A gL/gG |
| Short-circuit withstand for max. mains-side overcurrent protection | 50 kA eff |
| Operating temperature range | T_u -40 - +80 °C |
| Protection rating | IP20 |
| Approvals | UL, ÖVE, VDE, KEMA |
| Conductor cross-section, flexible (fine-wire) | 1.5 - 35 mm ² |
| Conductor cross-section, rigid (single wire/multi-wire) | 1.5 - 35 mm ² |
| Conductor cross-section, flexible (fine-wire) | 16 - 2 AWG |
| Conductor cross-section, rigid (single wire/multi-wire) | 16 - 2 AWG |

Connection options

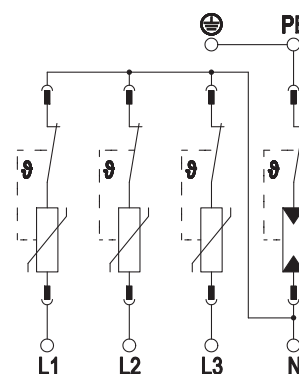

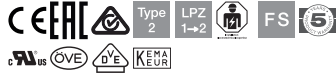

Surge arrester V20, 3-pole + NPE and remote signalling, 280 V

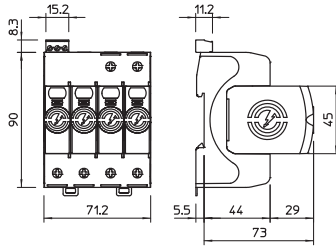

Surge arrester, type 2

- For surge voltage protection equipotential bonding to VDE 0100-443 (IEC 60364-4-44)
- Discharge capacity to 40 kA (8/20) per pole through high-performance varistors
- Modular connectable arrester with cut-off unit and visual status display
- Locking mechanism with vibration protection and voltage keying
- Plastic to UL 94 V-0
- The remote signalling variants (FS) have a potential-free changeover contact for remote signalling

Application: Equipotential bonding in main and sub-distributions.

| Type | Max. continuous voltage AC V | Pole version | Protection rating | Pack Piece | Weight kg/100 pc. | Item no. |
|------------------|------------------------------|--------------|-------------------|------------|-------------------|----------|
| V20-3+NPE+FS-280 | 280 | 3+N/PE | IP20 | 1 | 46.300 | 5095333 |

Connection options

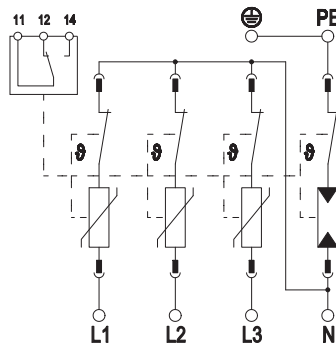

| V20-3+NPE+FS-280 | |
|--|----------------------------|
| SPD to EN 61643-11 | Type 2 |
| SPD to IEC 61643-11 | Class II |
| SPD to UL 1449 | Type 4 |
| Nominal voltage AC (50/60 Hz) | U_n 230 V |
| Maximum continuous voltage AC | U_c 280 V |
| Nominal discharge current (8/20 μ s) | $I_n / L-N$ 20 kA |
| Maximum discharge current (8/20 μ s) | I_{max} 40 kA |
| Arrester surge current (8/20 μ s) [total] | I_{total} 60 kA |
| Protection level [L-N] | U_b 1.3 kV |
| Combined voltage protection level [L-PE] | $U_{D/L-PE}$ 1.5 kV |
| Residual voltage [L-N] @ 1 kA | U_{res} 0,8 kV |
| Residual voltage [L-N] @ 5 kA | U_{res} 1,0 kV |
| Max. mains-side overcurrent protection | 160 A gL/gG |
| Short-circuit withstand for max. mains-side overcurrent protection | 50 kA eff |
| Operating temperature range | T_u -40 - +80 °C |
| Protection rating | IP20 |
| Approvals | UL, ÖVE, VDE, KEMA |
| FM contacts | Changeover |
| Switching power AC | 230 V; 0,5 A |
| Switching power DC | 230 V; 0,1 A / 75 V; 0,5 A |
| Connection cross-section, FM terminals | 0,5 - 1,5 mm ² |
| Connection cross-section, FM terminals | 21 - 16 AWG |
| Conductor cross-section, flexible (fine-wire) | 1,5 - 35 mm ² |
| Conductor cross-section, rigid (single wire/multi-wire) | 1,5 - 35 mm ² |
| Conductor cross-section, flexible (fine-wire) | 16 - 2 AWG |
| Conductor cross-section, rigid (single wire/multi-wire) | 16 - 2 AWG |

Schutzinstallationen Überspannungsschutz und Explosionsschutz / en / 2021/06/25 09:52:32 (LLExpert_02926) / 2021/06/25



Surge arrester V20, 4-pole, 280 V

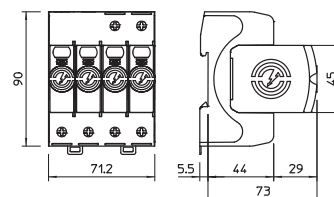
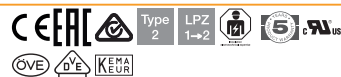

| Type | Max. continuous voltage AC V | Pole version | Protection rating | Pack Piece | Weight kg/100 pc. | Item no. |
|-----------|------------------------------|--------------|-------------------|------------|-------------------|----------|
| V20-4-280 | 280 | 4 | IP20 | 1 | 47.000 | 5095164 |

Surge arrester, type 2

- For surge voltage protection equipotential bonding to VDE 0100-443 (IEC 60364-4-44)
- Discharge capacity to 40 kA (8/20) per pole through high-performance varistors
- Modular connectable arrester with cut-off unit and visual status display
- Locking mechanism with vibration protection and voltage keying
- Plastic to UL 94 V-0
- The remote signalling variants (FS) have a potential-free changeover contact for remote signalling

Application: Equipotential bonding in main and sub-distributions.

V20-4-280

| | |
|--|--------------------------|
| SPD to EN 61643-11 | Type 2 |
| SPD to IEC 61643-11 | Class II |
| SPD to UL 1449 | Type 4 |
| Nominal voltage AC (50/60 Hz) | U_n 230 V |
| Maximum continuous voltage AC | U_c 280 V |
| Nominal discharge current (8/20 μ s) | $I_n / L-N$ 20 kA |
| Maximum discharge current (8/20 μ s) | I_{max} 40 kA |
| Arrester surge current (8/20 μ s) [total] | I_{total} 160 kA |
| Protection level [L-N] | U_p 1.3 kV |
| Residual voltage [L-N] @ 1 kA | U_{res} 0,8 kV |
| Residual voltage [L-N] @ 5 kA | U_{res} 1,0 kV |
| Max. mains-side overcurrent protection | 160 A gL/gG |
| Short-circuit withstand for max. mains-side overcurrent protection | 50 kA eff |
| Operating temperature range | T_u -40 - +80 °C |
| Protection rating | IP20 |
| Approvals | UL, ÖVE, VDE, KEMA |
| Conductor cross-section, flexible (fine-wire) | 1.5 - 35 mm ² |
| Conductor cross-section, rigid (single wire/multi-wire) | 1.5 - 35 mm ² |
| Conductor cross-section, flexible (fine-wire) | 16 - 2 AWG |
| Conductor cross-section, rigid (single wire/multi-wire) | 16 - 2 AWG |

Connection options

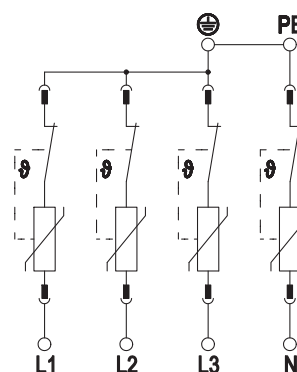

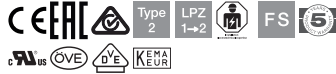

Surge arrester V20, 4-pole with remote signaling, 280 V

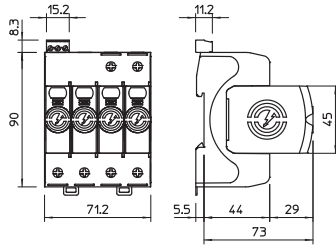

Surge arrester, type 2

- For surge voltage protection equipotential bonding to VDE 0100-443 (IEC 60364-4-44)
- Discharge capacity to 40 kA (8/20) per pole through high-performance varistors
- Modular connectable arrester with cut-off unit and visual status display
- Locking mechanism with vibration protection and voltage keying
- Plastic to UL 94 V-0
- The remote signalling variants (FS) have a potential-free changeover contact for remote signalling

Application: Equipotential bonding in main and sub-distributions.

| Type | Max. continuous voltage AC V | Pole version | Protection rating | Pack Piece | Weight kg/100 pc. | Item no. |
|--------------|------------------------------|--------------|-------------------|------------|-------------------|----------|
| V20-4+FS-280 | 280 | 4 | IP20 | 1 | 47.500 | 5095284 |

Connection options

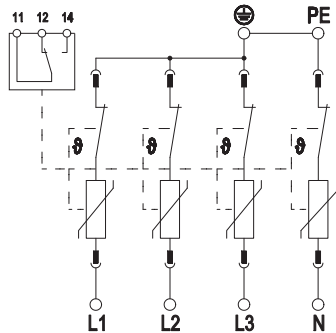

| V20-4+FS-280 | |
|--|----------------------------|
| SPD to EN 61643-11 | Type 2 |
| SPD to IEC 61643-11 | Class II |
| SPD to UL 1449 | Type 4 |
| Nominal voltage AC (50/60 Hz) | U_n 230 V |
| Maximum continuous voltage AC | U_c 280 V |
| Nominal discharge current (8/20 μ s) | $I_{n/L-N}$ 20 kA |
| Maximum discharge current (8/20 μ s) | I_{max} 40 kA |
| Arrester surge current (8/20 μ s) [total] | I_{total} 160 kA |
| Protection level [L-N] | U_b 1.3 kV |
| Residual voltage [L-N] @ 1 kA | U_{res} 0,8 kV |
| Residual voltage [L-N] @ 5 kA | U_{res} 1,0 kV |
| Max. mains-side overcurrent protection | 160 A gL/gG |
| Short-circuit withstand for max. mains-side overcurrent protection | 50 kA eff |
| Operating temperature range | T_u -40 - +80 °C |
| Protection rating | IP20 |
| Approvals | UL, ÖVE, VDE, KEMA |
| FM contacts | Changeover |
| Switching power AC | 230 V; 0,5 A |
| Switching power DC | 230 V; 0,1 A / 75 V; 0,5 A |
| Connection cross-section, FM terminals | 0,5 - 1,5 mm ² |
| Connection cross-section, FM terminals | 21 - 16 AWG |
| Conductor cross-section, flexible (fine-wire) | 1,5 - 35 mm ² |
| Conductor cross-section, rigid (single wire/multi-wire) | 1,5 - 35 mm ² |
| Conductor cross-section, flexible (fine-wire) | 16 - 2 AWG |
| Conductor cross-section, rigid (single wire/multi-wire) | 16 - 2 AWG |





Surge arrester V10 Compact 255 V

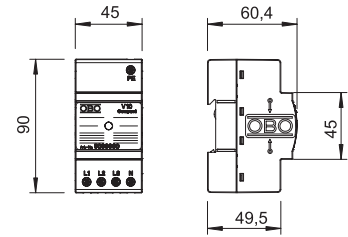

| Type | Highest continuous voltage V | Version | Pack Piece | Weight kg/100 pc. | Item no. |
|-----------------|------------------------------|---------|------------|-------------------|----------|
| V10 COMPACT 255 | 255 | 3 + NPE | 1 | 15.800 | 5093380 |

Surge protection device, compact module, type 2+3

- Surge protection in sub-distributors to VDE 0100-443 (IEC 60364-4-44)
- Arresting capacity up to 60 kA (8/20) in total
- Integrated 3+1 solution for TN and TT network systems on 45 mm module width
- High-performance varistor technology
- Incl. thermal and dynamic cut-off unit and visual function display

Application: Sub/storey distribution as well as device protection in rotational current systems.

V10 COMPACT 255

| | | |
|--|-------------------|--------------------------|
| Nominal voltage | U_N | 230 V |
| Max. continuous operating voltage | U_C | 255 V |
| SPD to EN 61643-11 | | Type 2+3 |
| SPD to IEC 61643-11 | | Class II+III |
| Lightning protection zone LPZ | | 1→3 |
| Nominal discharge current (8/20) | I_n | 10 kA |
| Arrestor surge current (8/20) [total] | $I_{Total\ 8/20}$ | 60 kA |
| Maximum discharge current (8/20 μ s) | I_{max} | 20 kA |
| Protection level | U_d | < 1,1 kV |
| Response time | t_A | < 25 ns |
| Maximum back-up fuse | | 63 A |
| Temperature range | ϑ | -40 - +80 °C |
| Division unit TE (17.5 mm) | | 1.5 |
| Protection rating | | IP20 |
| Connection cross-section, rigid | | 2.5 - 10 mm ² |
| Connection cross-section, multi-wire | | 2.5 - 10 mm ² |
| Connection cross-section, flexible | | 2.5 - 10 mm ² |

Connection options

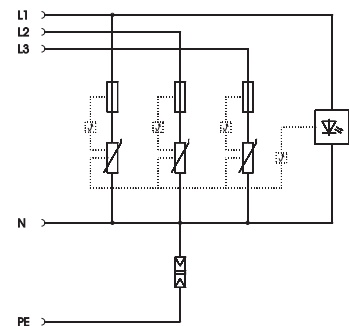



Surge arrester V10 Compact with audible signalling 255 V

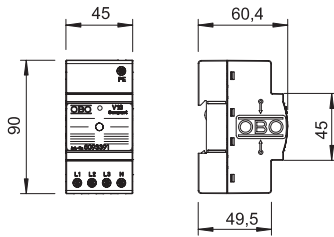

Surge protective device, compact module, type 2+3

- Surge protection in sub-distributors to VDE 0100-443 (IEC 60364-4-44)
- Arresting capacity up to 60 kA (8/20) in total
- Integrated 3+1 solution for TN and TT network systems on 45 mm module width
- High-performance varistor technology
- Including thermic and dynamic cut-off unit and visual function display
- ...-AS version with additional acoustic defect signalling (switchable)

Application: Sub/storey distribution as well as device protection in rotational current systems.

| Type | Highest continuous voltage V | Version | Pack Piece | Weight kg/100 pc. | Item no. |
|----------------|------------------------------|---------|------------|-------------------|----------|
| V10 COMPACT-AS | 255 | 3+NPE | 1 | 15.800 | 5093391 |

Connection options

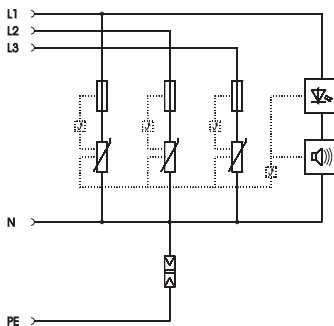

| V10 COMPACT-AS | | |
|--|-------------------|--------------------------|
| Nominal voltage | U_N | 230 V |
| Max. continuous operating voltage | U_C | 255 V |
| SPD to EN 61643-11 | | Type 2+3 |
| SPD to IEC 61643-11 | | Class II+III |
| Lightning protection zone LPZ | | 1→3 |
| Nominal discharge current (8/20) | I_n | 10 kA |
| Arrestor surge current (8/20) [total] | $I_{Total\ 8/20}$ | 60 kA |
| Maximum discharge current (8/20 μ s) | I_{max} | 20 kA |
| Protection level | U_p | < 1,1 kV |
| Response time | t_A | < 25 ns |
| Maximum back-up fuse | | 63 A |
| Temperature range | ϑ | -40 - +80 °C |
| Division unit TE (17.5 mm) | | 1.5 |
| Protection rating | | IP20 |
| Connection cross-section, rigid | | 2.5 - 10 mm ² |
| Connection cross-section, multi-wire | | 2.5 - 10 mm ² |
| Connection cross-section, flexible | | 2.5 - 10 mm ² |



Surge arrester V10 Compact with remote signalling 255 V

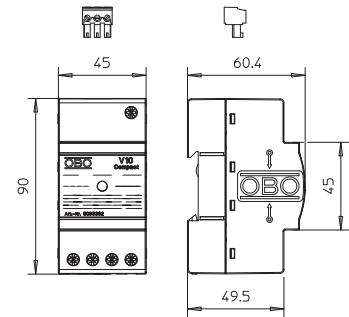

| Type | Highest continuous voltage V | Version | Pack Piece | Weight kg/100 pc. | Item no. |
|----------------|------------------------------|---------|------------|-------------------|----------|
| V10 COMPACT-FS | 255 | 3+NPE | 1 | 17.300 | 5093382 |

Surge protective device, compact module, type 2+3

- Surge protection in sub-distributors to VDE 0100-443 (IEC 60364-4-44)
- Arresting capacity up to 60 kA (8/20) in total
- Integrated 3+1 solution for TN and TT network systems on 45 mm module width
- High-performance varistor technology
- Including thermic and dynamic cut-off unit and visual function display
- ...-FS version with potential-free changeover contact for remote signalling

Application: Sub/storey distribution as well as device protection in rotational current systems.

| V10 COMPACT-FS | | | |
|--|-------------------|--------------------------|--|
| Nominal voltage | U_N | 230 V | |
| Max. continuous operating voltage | U_C | 255 V | |
| SPD to EN 61643-11 | | Type 2+3 | |
| SPD to IEC 61643-11 | | Class II+III | |
| Lightning protection zone LPZ | | 1→3 | |
| Nominal discharge current (8/20) | I_n | 10 kA | |
| Arrestor surge current (8/20) [total] | $I_{Total\ 8/20}$ | 60 kA | |
| Maximum discharge current (8/20 μ s) | I_{max} | 20 kA | |
| Protection level | U_p | < 1,1 kV | |
| Response time | t_A | < 25 ns | |
| Maximum back-up fuse | | 63 A | |
| Temperature range | ϑ | -40 - +80 °C | |
| Division unit TE (17.5 mm) | | 1.5 | |
| Protection rating | | IP20 | |
| Connection cross-section, rigid | | 2.5 - 10 mm ² | |
| Connection cross-section, multi-wire | | 2.5 - 10 mm ² | |
| Connection cross-section, flexible | | 2.5 - 10 mm ² | |

Connection options

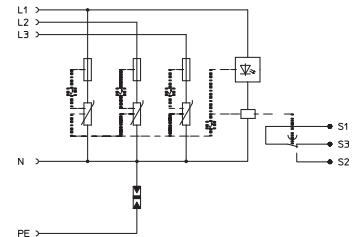



Combination arrester V50, 1-pole + NPE 280 V

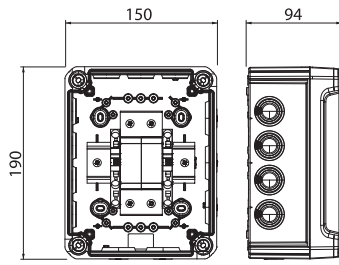

Lightning current combination arrester, type 1+2 to DIN EN 61643-11

- For lightning protection equipotential bonding to VDE 0185-305 (IEC 62305)
- Complete unit, pre-mounted and ready for connection in polycarbonate housing (IP66)
- Lightning current arresting capacity 12.5 kA (10/350) per pole and up to 50 kA (10/350) in total

Application: Lightning protection equipotential bonding for buildings of Class III and IV.
If there is a danger of condensation forming through wind, ice, temperature or sunlight, further measures may be necessary!

| Type | Max. continuous voltage AC V | Pole version | Pack Piece | Weight kg/100 pc. | Item no. |
|------------------|------------------------------|--------------|------------|-------------------|----------|
| VG-V50-1+NPE-280 | 280 | 1+N/PE | 1 | 81.000 | 5093594 |

Connection options

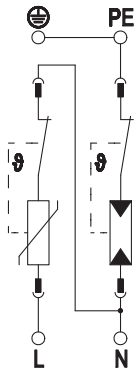

| VG-V50-1+NPE-280 | |
|--|--------------------------|
| SPD to EN 61643-11 | Type 1+2 |
| SPD to IEC 61643-11 | Class I-II |
| SPD to UL 1449 | Type 4 |
| Nominal voltage AC (50/60 Hz) | U_n 230 V |
| Maximum continuous voltage AC | U_c 280 V |
| Nominal discharge current (8/20 μ s) | $I_n / L-N$ 30 kA |
| Maximum discharge current (8/20 μ s) | I_{max} 50 kA |
| Lightning surge current (10/350 μ s) | I_{imp} 12.5 kA |
| Lightning surge current (10/350) | I_{total} 25 kA |
| Arrester surge current (8/20 μ s) [total] | I_{total} 50 kA |
| Protection level [L-N] | U_p 1.3 kV |
| Residual voltage [L-N] @ 1 kA | U_{res} 0,7 kV |
| Residual voltage [L-N] @ 5 kA | U_{res} 0,8 kV |
| Max. mains-side overcurrent protection | 160 A gL/gG |
| Short-circuit withstand for max. mains-side overcurrent protection | 50 kA eff |
| Operating temperature range | T_u -40 - +80 °C |
| Protection rating | IP66 |
| Approvals | UL, ÖVE, VDE |
| Conductor cross-section, flexible (fine-wire) | 1.5 - 35 mm ² |
| Conductor cross-section, rigid (single wire/multi-wire) | 1.5 - 35 mm ² |
| Conductor cross-section, flexible (fine-wire) | 16 - 2 AWG |
| Conductor cross-section, rigid (single wire/multi-wire) | 16 - 2 AWG |



Combination arrester V50, 3-pole + NPE 280 V

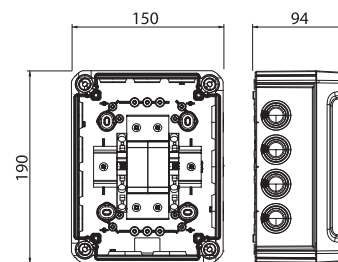

| Type | Max. continuous voltage AC V | Pole version | Pack Piece | Weight kg/100 pc. | Item no. |
|-------------------------|------------------------------|--------------|------------|-------------------|----------------|
| VG-V50-3+NPE-280 | 280 | 3+N/PE | 1 | 110.000 | 5093596 |

Lightning current combination arrester, type 1+2 to DIN EN 61643-11

- For lightning protection equipotential bonding to VDE 0185-305 (IEC 62305)
- Complete unit, pre-mounted and ready for connection in polycarbonate housing (IP66)
- Lightning current arresting capacity 12.5 kA (10/350) per pole and up to 50 kA (10/350) in total

Application: Lightning protection equipotential bonding for buildings of Class III and IV.

If there is a danger of condensation forming through wind, ice, temperature or sunlight, further measures may be necessary!

| VG-V50-3+NPE-280 | |
|--|--------------------------|
| SPD to EN 61643-11 | Type 1+2 |
| SPD to IEC 61643-11 | Class I+II |
| SPD to UL 1449 | Type 4 |
| Nominal voltage AC (50/60 Hz) | U_n 230 V |
| Maximum continuous voltage AC | U_c 280 V |
| Nominal discharge current (8/20 μ s) | $I_n / L-N$ 30 kA |
| Maximum discharge current (8/20 μ s) | I_{max} 50 kA |
| Lightning surge current (10/350 μ s) | I_{imp} 12.5 kA |
| Lightning surge current (10/350) | I_{total} 50 kA |
| Arrester surge current (8/20 μ s) [total] | I_{total} 50 kA |
| Protection level [L-N] | U_p 1.3 kV |
| Residual voltage [L-N] @ 1 kA | U_{res} 0,7 kV |
| Residual voltage [L-N] @ 5 kA | U_{res} 0,8 kV |
| Max. mains-side overcurrent protection | 160 A gL/gG |
| Short-circuit withstand for max. mains-side overcurrent protection | 50 kA eff |
| Operating temperature range | T_u -40 - +80 °C |
| Protection rating | IP66 |
| Approvals | UL, ÖVE, VDE |
| Conductor cross-section, flexible (fine-wire) | 1.5 - 35 mm ² |
| Conductor cross-section, rigid (single wire/multi-wire) | 1.5 - 35 mm ² |
| Conductor cross-section, flexible (fine-wire) | 16 - 2 AWG |
| Conductor cross-section, rigid (single wire/multi-wire) | 16 - 2 AWG |

Connection options

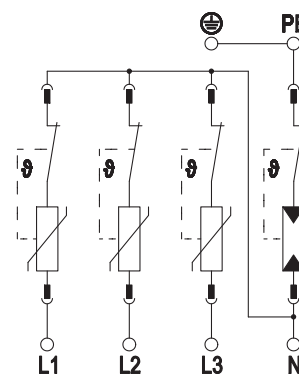



VG housing with MCD 50-B/3+1

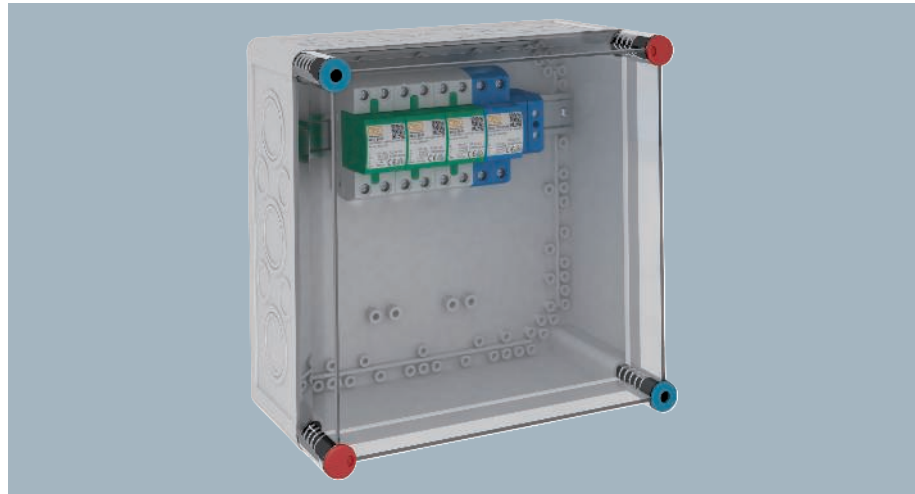
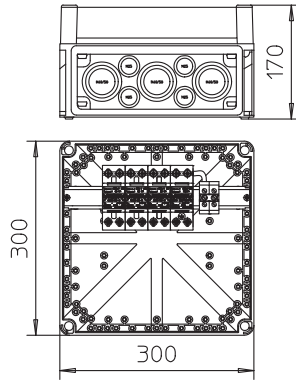

Combination arrester, pre-installed in IP65 housing for use in TN-S and TT networks.

VG...: Lightning arrester system solution type 1+2 according to DIN EN 61643-11.

- LightningController MCD 50-B and MCD 125-B/NPE mounted in insulating housing IP65, sealable housing
- Pulse current 125 kA (10/350 μ s), BET-tested
- Conforms to requirements of VDE-AR-N 4100
- Protection level < 1.7 kV (L-N) and < 1.5 kV (N-PE)
- Encapsulated, non-extinguishing discharge gap
- Suitable for TN-S and TT network systems

Application example: The system solution is used in the pre-meter area according to VDE-AR-N 4100.

| Type | Highest continuous voltage V | Version | Pack Piece | Weight kg/100 pc. | Item no. |
|-----------------|------------------------------|---------|------------|-------------------|----------|
| MCD 50-B 3+1-VG | 255 | 3+NPE | 1 | 290.000 | 5096875 |

Connection options

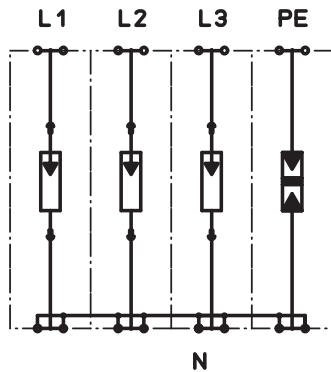

MCD 50-B 3+1-VG

| | | |
|--|------------------|-------------------------|
| Nominal voltage | U_N | 230 V |
| Max. continuous operating voltage | U_C | 255 V |
| SPD to EN 61643-11 | | Type 1+2 |
| SPD to IEC 61643-11 | | Class I+II |
| Lightning protection zone LPZ | | 0-2 |
| Impulse discharge current (10/350) | I_{imp} | 50 kA |
| Lightning surge current (10/350) | I_{total} | 125 kA |
| Nominal discharge current (8/20) | I_n | 50 kA |
| Arrestor surge current (8/20) [total] | $I_{Total 8/20}$ | 125 kA |
| Protection level | U_p | < 1,7 kV |
| Protection level (N-PE) | | < 1,5 kV |
| Response time | t_A | <100 ns |
| Follow current quenching capacity leff | $I_{fi eff}$ | 10 kA |
| Follow current quenching capacity (eff) [N-PE] | I_{fi} | 25 kA |
| Maximum back-up fuse | | 500 A |
| Temperature range | ϑ | -40 - +85 °C |
| Division unit TE (17.5 mm) | | 8 |
| Protection rating | | IP54 |
| Connection cross-section, rigid | | 10 - 50 mm ² |
| Connection cross-section, multi-wire | | 10 - 35 mm ² |
| Connection cross-section, flexible | | 10 - 25 mm ² |



VG housing with MCD 50-B/3

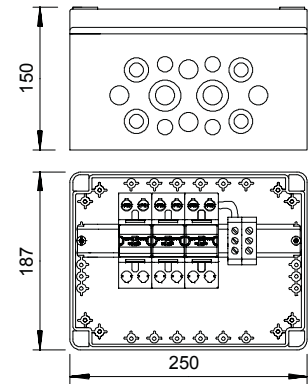
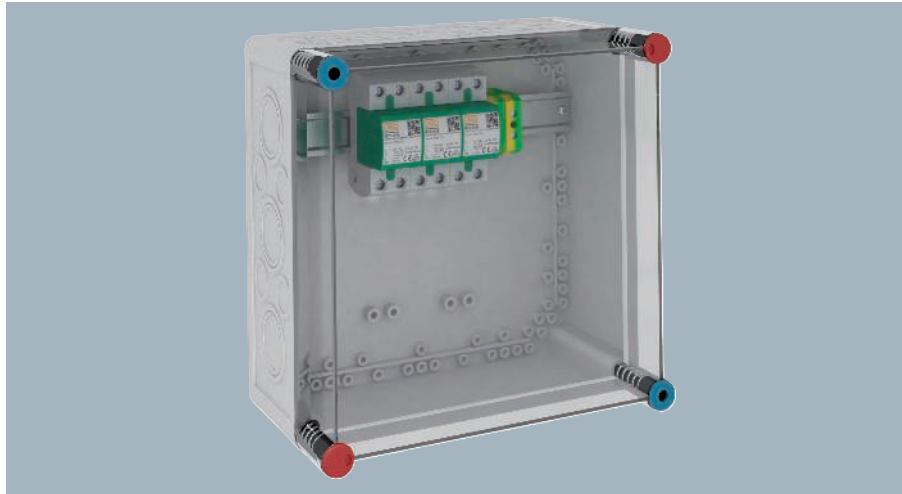

| Type | Highest continuous voltage V | Version | Pack Piece | Weight kg/100 pc. | Item no. |
|---------------|------------------------------|---------|------------|-------------------|----------|
| MCD 50-B 3-VG | 255 | 3-pole | 1 | 315.000 | 5096874 |

Combination arrester, pre-installed in IP65 housing for use in TN-C networks.

VG...: Combination arrester system solution, type 1+2, according to EN 61643-11.

- LightningController MCD 50-B mounted in insulating housing IP 65, sealable housing
- Pulse current 150 kA 10/350 μ s / 50 kA (10/350) per pole, BET-tested
- Protection level < 1.7 kV
- Encapsulated, non-extinguishing spark gaps
- Suitable for TN-C network systems

Application example: The system solution is used in the pre-meter area according to VDE-AR-N 4100.

MCD 50-B 3-VG

| | | |
|--|------------------|-------------------------|
| Nominal voltage | U_N | 230 V |
| Max. continuous operating voltage | U_C | 255 V |
| SPD to EN 61643-11 | | Type 1+2 |
| SPD to IEC 61643-11 | | Class I+II |
| Lightning protection zone LPZ | | 0-2 |
| Impulse discharge current (10/350) | I_{imp} | 50 kA |
| Lightning surge current (10/350) | I_{total} | 150 kA |
| Nominal discharge current (8/20) | I_n | 50 kA |
| Arrestor surge current (8/20) [total] | $I_{Total 8/20}$ | 150 kA |
| Protection level | U_p | < 1,7 kV |
| Response time | t_A | <100 ns |
| Follow current quenching capacity I_{fi} | $I_{fi eff}$ | 10 kA |
| Maximum back-up fuse | | 500 A |
| Temperature range | ϑ | -40 - +85 °C |
| Division unit TE (17.5 mm) | | 6 |
| Protection rating | | IP54 |
| Connection cross-section, rigid | | 10 - 50 mm ² |
| Connection cross-section, multi-wire | | 10 - 35 mm ² |
| Connection cross-section, flexible | | 10 - 25 mm ² |

Connection options

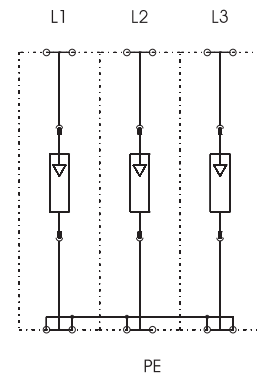



System solution, surge arrester V20 in housing, 1-pole + NPE, 280 V

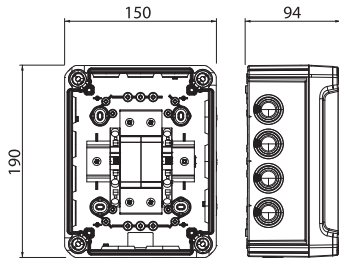

Surge arrester, type 2, according DIN EN 61643-11

- For surge voltage protection equipotential bonding to VDE 0100-443 (IEC 60364-4-44)
- Complete unit, pre-mounted and ready for connection in polycarbonate housing (IP66)
- Arresting capacity to 40 kA (8/20) per pole through high-performance varistors

Application: Equipotential bonding in main and sub-distributors. If there is a danger of condensation forming through wind, ice, temperature or sunlight, further measures may be necessary!

| Type | Max. continuous voltage AC V | Pole version | Pack Piece | Weight kg/100 pc. | Item no. |
|------------------|------------------------------|--------------|------------|-------------------|----------|
| VG-V20-1+NPE-280 | 280 | 1+N/PE | 1 | 74.000 | 5095381 |

Connection options

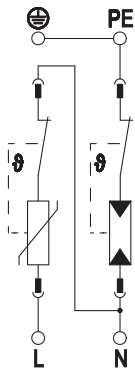

| VG-V20-1+NPE-280 | |
|--|--------------------------|
| SPD to EN 61643-11 | Type 2 |
| SPD to IEC 61643-11 | Class II |
| SPD to UL 1449 | Type 4 |
| Nominal voltage AC (50/60 Hz) | U_n 230 V |
| Maximum continuous voltage AC | U_c 280 V |
| Nominal discharge current (8/20 μ s) | $I_{n/L-N}$ 20 kA |
| Maximum discharge current (8/20 μ s) | I_{max} 40 kA |
| Arrester surge current (8/20 μ s) [total] | I_{total} 60 kA |
| Protection level [L-N] | U_p 1.3 kV |
| Residual voltage [L-N] @ 1 kA | U_{res} 0,7 kV |
| Residual voltage [L-N] @ 5 kA | U_{res} 0,9 kV |
| Max. mains-side overcurrent protection | 160 A gL/gG |
| Short-circuit withstand for max. mains-side overcurrent protection | 50 kA eff |
| Operating temperature range | T_u -40 - +80 °C |
| Protection rating | IP66 |
| Approvals | ÖVE, UL |
| Conductor cross-section, flexible (fine-wire) | 1.5 - 35 mm ² |
| Conductor cross-section, rigid (single wire/multi-wire) | 1.5 - 35 mm ² |
| Conductor cross-section, flexible (fine-wire) | 16 - 2 AWG |
| Conductor cross-section, rigid (single wire/multi-wire) | 16 - 2 AWG |



System solution, surge arrester V20 in housing, 3-pole + NPE, 280 V

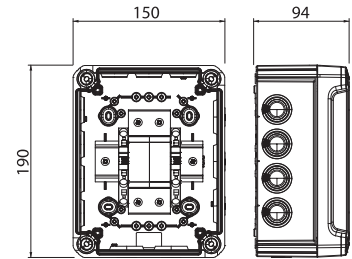

| Type | Max. continuous voltage V | Pole version | Pack Piece | Weight kg/100 pc. | Item no. |
|-------------------------|---------------------------|--------------|------------|-------------------|----------------|
| VG-V20-3+NPE-280 | 280 | 3+N/PE | 1 | 96.000 | 5095383 |

Surge arrester, type 2, according DIN EN 61643-11

- For surge voltage protection equipotential bonding to VDE 0100-443 (IEC 60364-4-44)
- Complete unit, pre-mounted and ready for connection in polycarbonate housing (IP66)
- Arresting capacity to 40 kA (8/20) per pole through high-performance varistors

Application: Equipotential bonding in main and sub-distributors. If there is a danger of condensation forming through wind, ice, temperature or sunlight, further measures may be necessary!

| VG-V20-3+NPE-280 | | Type 2 |
|--|-------------|--------------------------|
| SPD to EN 61643-11 | | Class II |
| SPD to IEC 61643-11 | | Type 4 |
| SPD to UL 1449 | | |
| Nominal voltage AC (50/60 Hz) | U_n | 230 V |
| Maximum continuous voltage AC | U_C | 280 V |
| Nominal discharge current (8/20 μ s) | $I_n / L-N$ | 20 kA |
| Maximum discharge current (8/20 μ s) | I_{max} | 40 kA |
| Arrester surge current (8/20 μ s) [total] | I_{total} | 60 kA |
| Protection level [L-N] | U_D | 1.3 kV |
| Residual voltage [L-N] @ 1 kA | U_{res} | 0,7 kV |
| Residual voltage [L-N] @ 5 kA | U_{res} | 0,9 kV |
| Max. mains-side overcurrent protection | | 160 A gL/gG |
| Short-circuit withstand for max. mains-side overcurrent protection | | 50 kA eff |
| Operating temperature range | T_u | -40 - +80 °C |
| Protection rating | | IP66 |
| Approvals | | ÖVE, UL |
| Conductor cross-section, flexible (fine-wire) | | 1.5 - 35 mm ² |
| Conductor cross-section, rigid (single wire/multi-wire) | | 1.5 - 35 mm ² |
| Conductor cross-section, flexible (fine-wire) | | 16 - 2 AWG |
| Conductor cross-section, rigid (single wire/multi-wire) | | 16 - 2 AWG |

Connection options

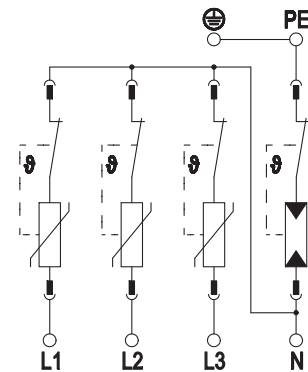

Compact surge protection

Surge protection module type 2+3 to DIN EN 61643-11 for 230/400 V power grids to protect LED lighting and/or the LED driver.

Application in:

- Cable fuse box in the street lighting pole
- Junction boxes
- Cable ducts
- Underfloor systems
- Electrical equipment



Surge protective devices type 2+3

- With function display and switch-off of the load current circuit should the SPD fail
- Small construction size for installation in the pole connection box or in front of the driver
- Reduction of the surge voltage to below 1,300 V (protection level)
- Optionally available as IP65 version



Surge protection for LED systems ÜSM-20-230I1P+PE

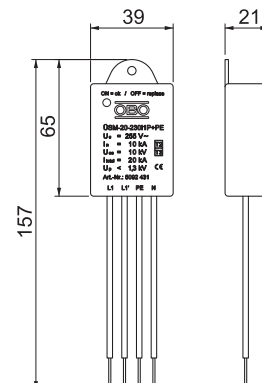

| Type | Highest continuous voltage V | Version | Pack Piece | Weight kg/100 pc. | Item no. |
|-------------------------|------------------------------|----------------------|------------|-------------------|----------------|
| ÜSM-20-230I1P+PE | 255 | 1-pole + NPE for PCI | 1 | 4.100 | 5092431 |

Surge protection module type 2+3 to DIN EN 61643-11 for 230/400 V power grids. Appropriate for the protection of LED lighting.

- With function display and switch-off of the load circuit when an SPD fails
- Small size for the installation in the pole connection box or upstream of the LED driver
- 1+NPE protective circuit with a maximum discharge capacity of 20 kA
- Reduction of overvoltage to under 1,300 V or 1,000 V @ 5 kA
- With or without luminaire switch-off in case of defect

Application: In the cable transition box, junction boxes, cable duct to underfloor systems

| ÜSM-20-230I1P+PE | | | |
|--|-------------------|--|--------------|
| Nominal voltage | U_N | | 230 V |
| Max. continuous operating voltage | U_C | | 255 V |
| SPD to EN 61643-11 | | | Type 2+3 |
| SPD to IEC 61643-11 | | | Class II+III |
| Lightning protection zone LPZ | | | 1→2 |
| Nominal discharge current (8/20) | I_n | | 10 kA |
| Arrestor surge current (8/20) [total] | $I_{Total\ 8/20}$ | | 20 kA |
| Maximum discharge current (8/20 μ s) | I_{max} | | 20 kA |
| Protection level | U_p | | 1,3 kV |
| Response time | t_A | | < 25 ns |
| Maximum back-up fuse | | | 16 A |
| Operating temperature range | T_u | | -40 - +80 °C |
| Protection rating | | | IP20 |
| Connecting cable length | | | 0.09 m |

Connection options

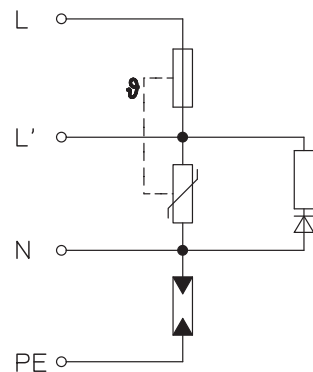



Surge protection for LED systems ÜSM-20-2301PE65

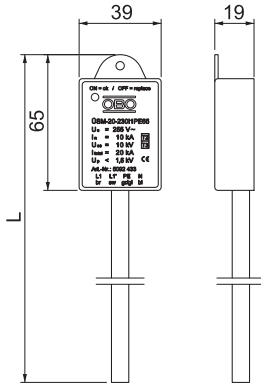

Surge protection module type 2+3 to DIN EN 61643-11 for 230/400 V power grids. Appropriate for the protection of LED lighting.

- With function display and switch-off of the load circuit when an SPD fails
- Small size for the installation in the pole connection box or upstream of the LED driver
- 1+NPE protective circuit with a maximum discharge capacity of 20 kA
- Reduction of overvoltage to under 1,500 V or 1,000 V @ 5 kA
- With or without luminaire switch-off in case of defect

Application: In the cable transition box, junction boxes, cable ducts to underfloor systems

| Type | Highest continuous voltage V | Version | Pack Piece | Weight kg/100 pc. | Item no. |
|------------------------|------------------------------|----------------------|------------|-------------------|----------------|
| ÜSM-20-2301PE65 | 255 | 1-pole + NPE for PCI | 1 | 8.300 | 5092433 |

Connection options

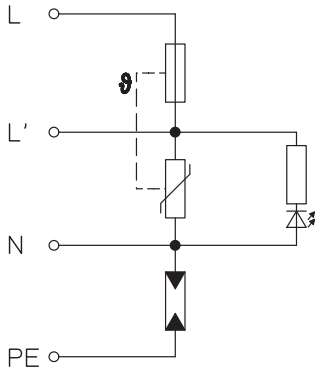

| ÜSM-20-2301PE65 | | |
|--|-------------------|--------------|
| Nominal voltage | U_N | 230 V |
| Max. continuous operating voltage | U_C | 255 V |
| SPD to EN 61643-11 | | Type 2+3 |
| SPD to IEC 61643-11 | | Class II+III |
| Lightning protection zone LPZ | | 1→2 |
| Nominal discharge current (8/20) | I_n | 10 kA |
| Arrestor surge current (8/20) [total] | $I_{Total\ 8/20}$ | 20 kA |
| Maximum discharge current (8/20 μ s) | I_{max} | 20 kA |
| Protection level | U_p | 1,5 kV |
| Response time | t_A | < 25 ns |
| Maximum back-up fuse | | 16 A |
| Operating temperature range | T_u | -40 - +80 °C |
| Protection rating | | IP65 |
| Connecting cable length | | 0.25 m |



Surge protection module ÜSM-10-230I1P+PE

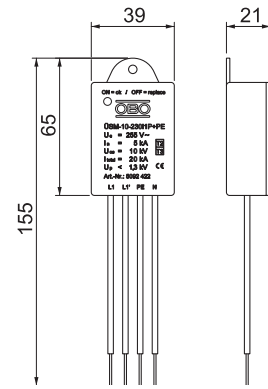

| Type | Highest continuous voltage V | Version | Pack Piece | Weight kg/100 pc. | Item no. |
|------------------|------------------------------|----------------------|------------|-------------------|----------|
| ÜSM-10-230I1P+PE | 255 | 1-pole + NPE for PCI | 1 | 3.500 | 5092422 |

Surge protection module type 2+3 to DIN EN 61643-11 for 230/400 V power grids. Appropriate for the protection of electronic devices and LED drivers.

- With function display and switch-off of the load circuit when an SPD fails
- Small size for the installation in the pole connection box or upstream of the LED driver
- Use in the LED luminaire head upstream of the electronic LED driver
- Protective circuit with a maximum arresting capacity of 10 kA
- Reduction of overvoltage to under 1,300 V (protection level)
- For LED luminaires with PE connection

Application: In the cable transition box, junction boxes, cable duct to underfloor systems

| ÜSM-10-230I1P+PE | | |
|---------------------------------------|-------------------|--------------|
| Nominal voltage | U_N | 230 V |
| Max. continuous operating voltage | U_C | 255 V |
| SPD to EN 61643-11 | | Type 2+3 |
| SPD to IEC 61643-11 | | Class II+III |
| Lightning protection zone LPZ | | 1→2 |
| Nominal discharge current (8/20) | I_n | 5 kA |
| Arrestor surge current (8/20) [total] | $I_{Total\ 8/20}$ | 10 kA |
| Maximum discharge current (8/20 µs) | I_{max} | 10 kA |
| Protection level | U_p | 1,3 kV |
| Response time | t_A | < 25 ns |
| Maximum back-up fuse | | 16 A |
| Operating temperature range | T_u | -40 - +80 °C |
| Protection rating | | IP20 |
| Connecting cable length | | 0.09 m |

Connection options

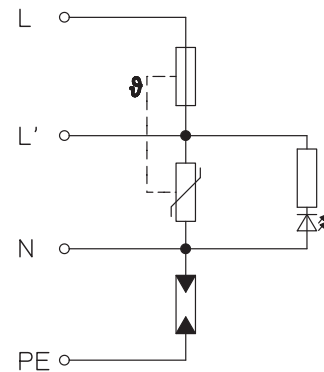



Surge protection module ÜSM-10-230I1P-0

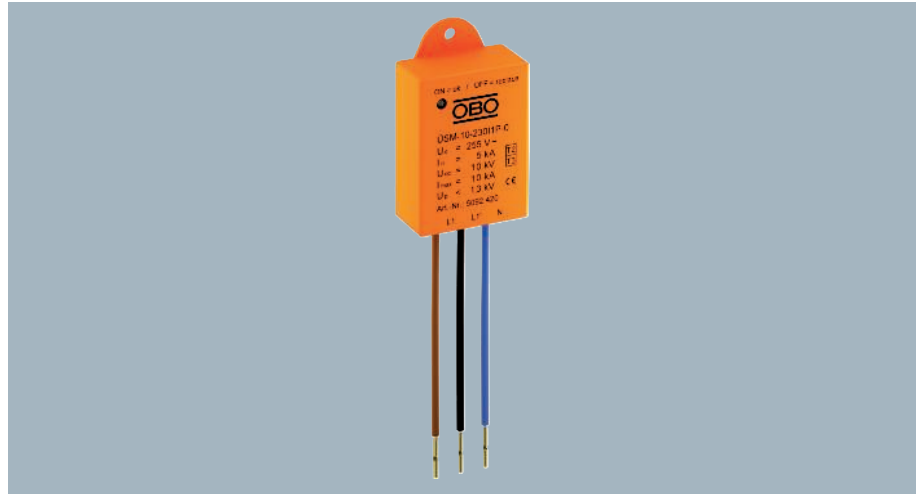
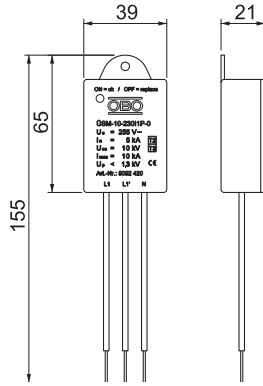

Surge protection module type 2+3 to DIN EN 61643-11 for 230/400 V power grids. Appropriate for the protection of electronic devices and LED drivers.

- With function display and switch-off of the load circuit when an SPD fails
- Small size for the installation in the pole connection box or upstream of the LED driver
- Protective circuit with a maximum arresting capacity of 10 kA
- Reduction of overvoltage to under 1,300 V (protection level)
- For protection insulated luminaires (PC II) without PE connection

Application: In the cable transition box, junction boxes, cable duct to underfloor systems

| Type | Highest continuous voltage V | Version | Pack Piece | Weight kg/100 pc. | Item no. |
|-----------------|------------------------------|------------------------------|------------|-------------------|----------|
| ÜSM-10-230I1P-0 | 255 | 1-pole without NPE for PC II | 1 | 3.200 | 5092420 |

Connection options

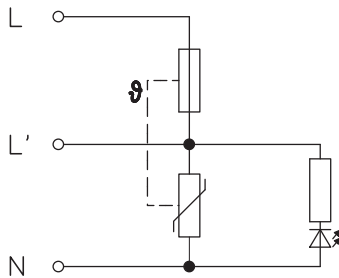

| ÜSM-10-230I1P-0 | | |
|--|-------------------|--------------|
| Nominal voltage | U_N | 230 V |
| Max. continuous operating voltage | U_C | 255 V |
| SPD to EN 61643-11 | | Type 2+3 |
| SPD to IEC 61643-11 | | Class II+III |
| Lightning protection zone LPZ | | 1-2 |
| Nominal discharge current (8/20) | I_n | 5 kA |
| Arrestor surge current (8/20) [total] | $I_{Total\ 8/20}$ | — kA |
| Maximum discharge current (8/20 μ s) | I_{max} | 10 kA |
| Protection level | U_o | 1,3 kV |
| Response time | t_A | < 25 ns |
| Maximum back-up fuse | | 16 A |
| Operating temperature range | T_u | -40 - +80 °C |
| Protection rating | | IP20 |
| Connecting cable length | | 0.09 m |



Surge protection module ÜSM-10-230I2P+PE

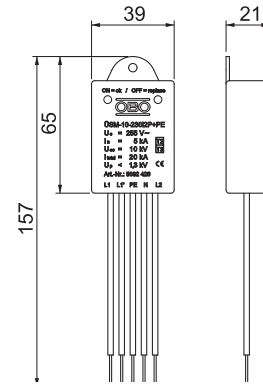

| Type | Highest continuous voltage V | Version | Pack Piece | Weight kg/100 pc. | Item no. |
|------------------|------------------------------|----------------------|------------|-------------------|----------|
| ÜSM-10-230I2P+PE | 255 | 2-pole + NPE for PCI | 1 | 4.400 | 5092426 |

Surge protection module type 2+3 to DIN EN 61643-11 for 230/400 V power grids. Appropriate for the protection of electronic devices and LED drivers.

- For luminaires with 2 phases (power reduction)
- With function display and switch-off of the load circuit when an SPD fails
- Small size for the installation in the pole connection box or upstream of the LED driver
- Protective circuit with a maximum arresting capacity of 10 kA
- Reduction of overvoltage to under 1,300 V (protection level)
- For LED luminaires with PE connection

Application: In the cable transition box, junction boxes, cable duct to underfloor systems

| ÜSM-10-230I2P+PE | | |
|--|------------------|--------------|
| Nominal voltage | U_N | 230 V |
| Max. continuous operating voltage | U_C | 255 V |
| SPD to EN 61643-11 | | Type 2+3 |
| SPD to IEC 61643-11 | | Class II+III |
| Lightning protection zone LPZ | | 1→2 |
| Nominal discharge current (8/20) | I_n | 5 kA |
| Arrestor surge current (8/20) [total] | $I_{Total 8/20}$ | 10 kA |
| Maximum discharge current (8/20 μ s) | I_{max} | 10 kA |
| Protection level | U_p | 1,3 kV |
| Response time | t_A | < 25 ns |
| Maximum back-up fuse | | 16 A |
| Operating temperature range | T_u | -40 - +80 °C |
| Protection rating | | IP20 |
| Connecting cable length | | 0.09 m |

Connection options

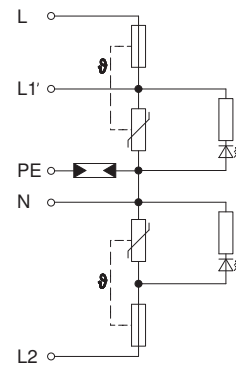



Surge protection module ÜSM-10-230I2P-0

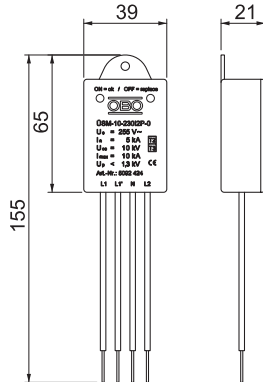

Surge protection module type 2+3 to DIN EN 61643-11 for 230/400 V power grids. Appropriate for the protection of electronic devices and LED drivers.

- For luminaires with 2 phases (power reduction)
- With function display and switch-off of the load circuit when an SPD fails
- Small size for the installation in the pole connection box or upstream of the LED driver
- Protective circuit with a maximum arresting capacity of 10 kA
- Reduction of overvoltage to under 1,300 V (protection level)
- For protection insulated luminaires (PC II) without PE connection

Application: In the cable transition box, junction boxes, cable duct to underfloor systems

| Type | Highest continuous voltage V | Version | Pack Piece | Weight kg/100 pc. | Item no. |
|-----------------|------------------------------|------------------------------|------------|-------------------|----------|
| ÜSM-10-230I2P-0 | 255 | 2-pole without NPE for SK II | 1 | 4.100 | 5092424 |

Connection options

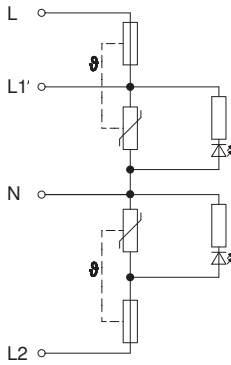

ÜSM-10-230I2P-0

| | | |
|--|-------------------|--------------|
| Nominal voltage | U_N | 230 V |
| Max. continuous operating voltage | U_C | 255 V |
| SPD to EN 61643-11 | | Type 2+3 |
| SPD to IEC 61643-11 | | Class II+III |
| Lightning protection zone LPZ | | 1→2 |
| Nominal discharge current (8/20) | I_n | 5 kA |
| Arrestor surge current (8/20) [total] | $I_{Total\ 8/20}$ | — kA |
| Maximum discharge current (8/20 μ s) | I_{max} | 10 kA |
| Protection level | U_p | 1,3 kV |
| Response time | t_A | < 25 ns |
| Maximum back-up fuse | | 16 A |
| Operating temperature range | T_u | -40 - +80 °C |
| Protection rating | | IP20 |
| Connecting cable length | | 0.09 m |



Surge protection module 230 V

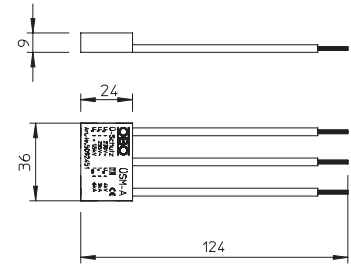

| Type | Signalling on device | Version | Pack Piece | Weight kg/100 pc. | Item no. |
|-------|----------------------|----------------------------|------------|-------------------|----------|
| ÜSM-A | Acoustic | Acoustic operating display | 1 | 1.500 | 5092451 |

Surge protection module type 3 to DIN EN 61643-11 for 230 V power grids.

- With audible defect signal
- With low construction height
- Halogen-free plastic (UL 94 V-0)
- Y circuit

Application: Universally applicable for all installation systems.

ÜSM-A

| | | |
|--|-------------|--------------|
| Nominal voltage | U_N | 230 V |
| Max. continuous operating voltage | U_C | 255 V |
| SPD to EN 61643-11 | | Type 3 |
| SPD to IEC 61643-11 | | Class III |
| Lightning protection zone LPZ | | 2→3 |
| Nominal discharge current (8/20) | I_n | 3 kA |
| Protection level (L-N) | | < 1,3 kV |
| Protection level (N-PE) | | < 1,5 kV |
| Maximum back-up fuse | | 16 A |
| Response time | t_A | < 25 ns |
| Temperature range | ϑ | -15 - +60 °C |
| Maximum discharge current (8/20 μ s) | I_{max} | 6 kA |
| Rated current | I_L | 16 A |

Connection options

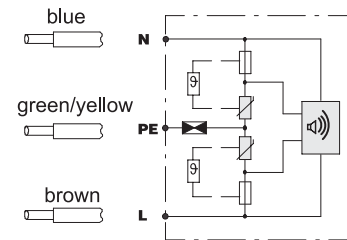



Fine power protection 230 V protective contact sockets

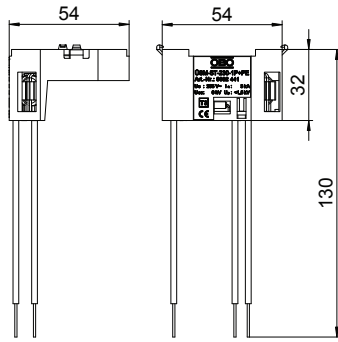

Surge protection / fine power protection, type 3, to EN 61643-11 for protective contact sockets.

- Thermal cut-off unit with acoustic defect signalling
- Y protection circuit for increased safety
- Mounting through snapping onto the support ring of the socket
- Halogen-free plastic (UL 94 V-0)
- Labelling of the socket with supplied sign

Application: For retrofitting on standard Schuko sockets.

| Type | Signalling on device | Version | Pack Piece | Weight kg/100 pc. | Item no. |
|------------------|----------------------|---------------------------|------------|-------------------|----------|
| ÜSM-ST-230-1P+PE | Acoustic | Acoustic function display | 1 | 1.770 | 5092441 |

Connection options

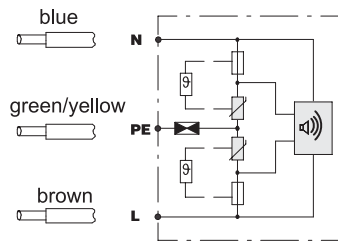

| ÜSM-ST-230-1P+PE | |
|--|-------------------------|
| Nominal voltage | U_N 230 V |
| Max. continuous operating voltage | U_C 255 V |
| SPD to EN 61643-11 | Type 3 |
| SPD to IEC 61643-11 | Class III |
| Lightning protection zone LPZ | 2-3 |
| Nominal discharge current (8/20) | I_n 3 kA |
| Maximum discharge current (8/20 μ s) | I_{max} 5 kA |
| Protection level (L-N) | < 1,5 kV |
| Protection level (N-PE) | < 1,5 kV |
| Maximum back-up fuse | 16 A |
| Response time | t_A 25 ns |
| Temperature range | ϑ -5 - +40 °C |



Surge protection module 230 V with holder for GB2 and GB3 mounting boxes

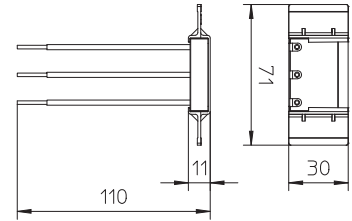
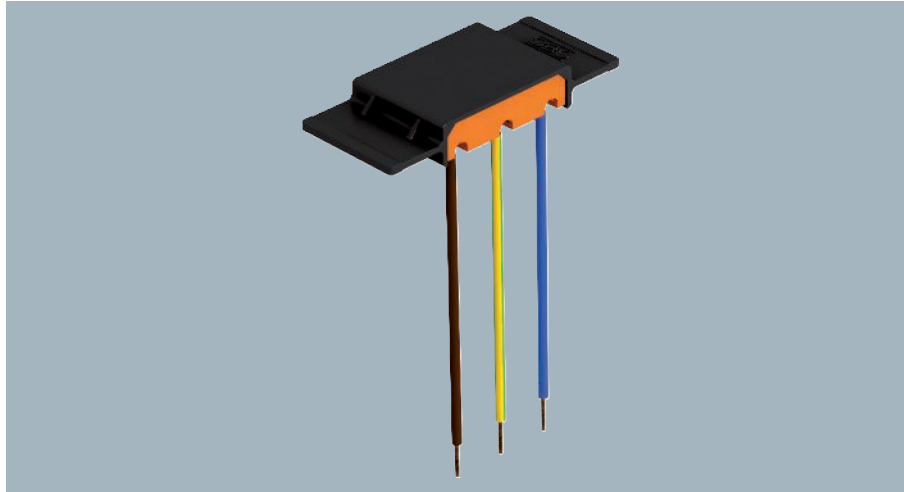

| Type | Signalling on device | Version | Pack Piece | Weight kg/100 pc. | Item no. |
|---------|----------------------|--------------------------------------|------------|-------------------|----------|
| ÜSM-A-4 | Acoustic | Incl. holder with partition function | 1 | 2.000 | 5092472 |

Surge protection module type 3 to DIN EN 61643-11 for 230 V power grids.

- With acoustic defect signal
- With low construction height and Y circuit
- With halogen-free plastic (UL 94 V-0)
- Holder with separating retainer function for GB2 / GB3 mounting boxes and UT3 and UT4 universal supports

Application: Universally applicable for all installation systems.

| ÜSM-A-4 | |
|--|--------------------------|
| Nominal voltage | U_N 230 V |
| Max. continuous operating voltage | U_C 255 V |
| SPD to EN 61643-11 | Type 3 |
| SPD to IEC 61643-11 | Class III |
| Lightning protection zone LPZ | 2→3 |
| Nominal discharge current (8/20) | I_n 3 kA |
| Maximum discharge current (8/20 μ s) | I_{max} 6 kA |
| Protection level (L-N) | < 1,3 kV |
| Protection level (N-PE) | < 1,5 kV |
| Maximum back-up fuse | 16 A |
| Response time | t_A < 25 ns |
| Temperature range | ϑ -15 - +60 °C |

Connection options

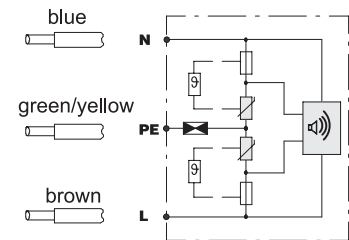



Surge protective device 230 V for through wiring

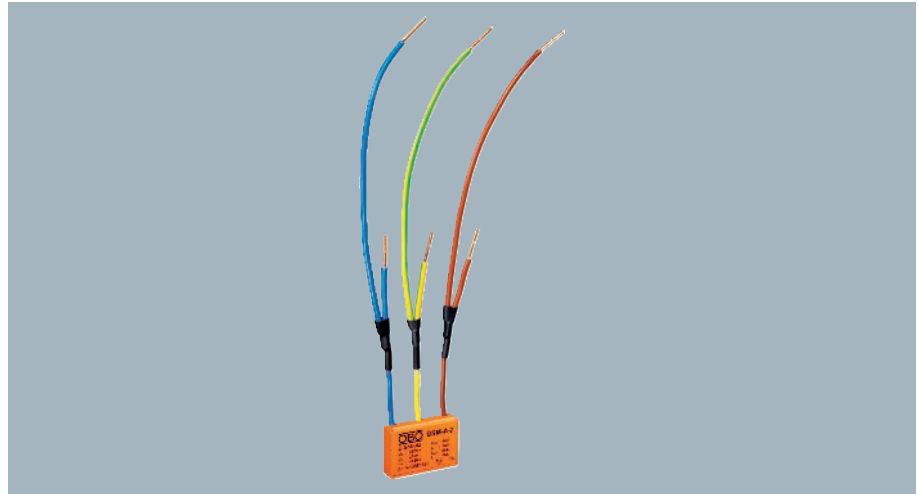
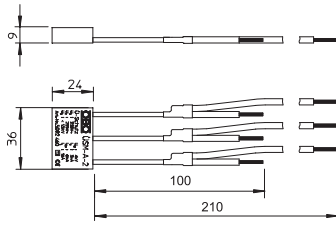

Surge protective device type 3 to DIN EN 61643-11 for 230 V networks.

- With acoustic defect signal
- With 2 strands for continuous wiring
- With low construction height
- Halogen-free plastic (UL 94 V-0)
- Y circuit

Application: Universally applicable for all installation systems.

| Type | Signalling on device | Version | Pack Piece | Weight kg/100 pc. | Item no. |
|---------|----------------------|--------------|------------|-------------------|----------|
| ÜSM-A-2 | Acoustic | V connection | 1 | 2.200 | 5092460 |

Connection options

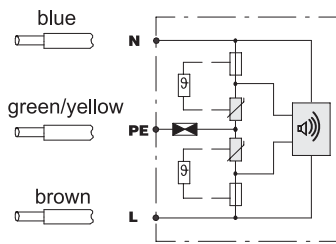

ÜSM-A-2

| | | |
|--|-------------|--------------|
| Nominal voltage | U_N | 230 V |
| Max. continuous operating voltage | U_C | 255 V |
| SPD to EN 61643-11 | | Type 3 |
| SPD to IEC 61643-11 | | Class III |
| Lightning protection zone LPZ | | 2-3 |
| Nominal discharge current (8/20) | I_n | 3 kA |
| Protection level (L-N) | | < 1,3 kV |
| Protection level (N-PE) | | < 1,5 kV |
| Maximum back-up fuse | | 16 A |
| Response time | t_A | < 25 ns |
| Temperature range | ϑ | -15 - +60 °C |
| Maximum discharge current (8/20 μ s) | I_{max} | 6 kA |
| Rated current | I_L | 16 A |



Fine power protection for Modul 45 with acoustic function display

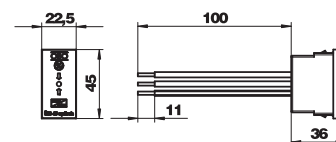

| Type | Signalling on device | Version | Pack Piece | Weight kg/100 pc. | Item no. |
|-------------|----------------------|-------------------------|------------|-------------------|----------|
| ÜSS 45-O-RW | Visual | Visual function display | 1 | 2.411 | 6117473 |

Surge protection / network fine protection, type 3, according to EN 61643-11 for installation in Rapid 45 trunking, device installation trunking and underfloor systems.

- Version-O with acoustic function display
- Quick and easy mounting
- Low construction width of 22.5 mm
- Colour: Pure white; RAL 9010

Application: The surge protective device secures downstream and nearby sockets.

ÜSS 45-O-RW

| | | |
|-----------------------------------|-------------|--------------|
| Nominal voltage | U_N | 230 V |
| Max. continuous operating voltage | U_C | 255 V |
| SPD to EN 61643-11 | | Type 3 |
| SPD to IEC 61643-11 | | Class III |
| Lightning protection zone LPZ | | 2-3 |
| Nominal discharge current (8/20) | I_n | 2.5 kA |
| Protection level (L-N) | | < 1,5 kV |
| Protection level (N-PE) | | < 1,5 kV |
| Maximum back-up fuse | | 16 A |
| Response time | t_A | 25 ns |
| Temperature range | ϑ | -25 - +45 °C |

Connection options

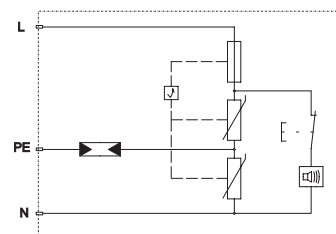



Surge protection module for Modul 45 with audible signalling

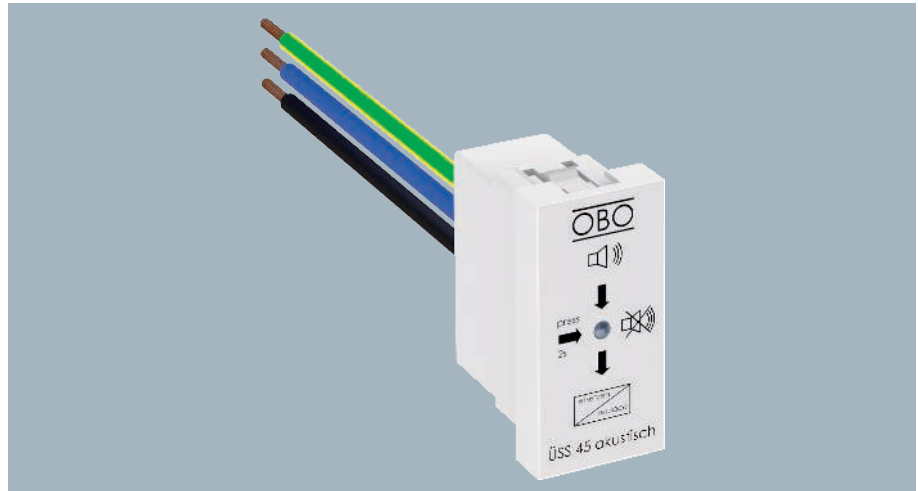
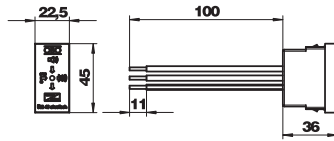

Surge protection / network fine protection, type 3, according to EN 61643-11 for installation in Rapid 45 trunking, device installation trunking and underfloor systems.

- Version-A with acoustic function display (switchable signal tone)
- Quick and easy mounting
- Low construction width of 22.5 mm
- Colour: Pure white; RAL 9010

Application: The surge protection device secures downstream and nearby sockets.

| Type | Signalling on device | Version | Pack Piece | Weight kg/100 pc. | Item no. |
|-------------|----------------------|---------------------------|------------|-------------------|----------|
| ÜSS 45-A-RW | Acoustic | Acoustic function display | 1 | 2.800 | 6117465 |

Connection options

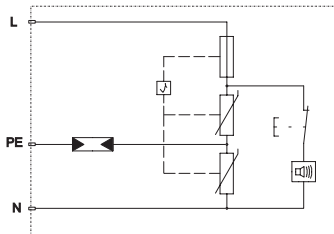

| ÜSS 45-A-RW | |
|-----------------------------------|--------------------------|
| Nominal voltage | U_N 230 V |
| Max. continuous operating voltage | U_C 255 V |
| SPD to EN 61643-11 | Type 3 |
| SPD to IEC 61643-11 | Class III |
| Lightning protection zone LPZ | 2→3 |
| Nominal discharge current (8/20) | I_n 2.5 kA |
| Protection level (L-N) | < 1,5 kV |
| Protection level (N-PE) | < 1,5 kV |
| Maximum back-up fuse | 16 A |
| Response time | t_A 25 ns |
| Temperature range | ϑ -25 - +45 °C |



FineController FC-SAT for SAT systems and receivers

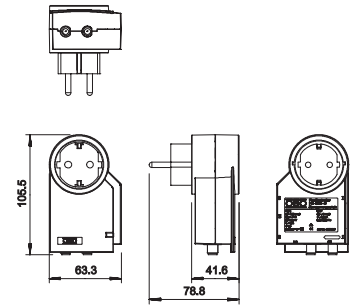

| Type | Country version | Colour | Pack Piece | Weight kg/100 pc. | Item no. |
|----------|-----------------|------------|------------|-------------------|----------|
| FC-SAT-D | EN | Pure white | 1 | 16.000 | 5092816 |

Type 3 combined surge protection to EN 61643-11, designed for use on satellite systems and receivers.

- Adapter connector
- Cut-off unit and function display
- With increased contact protection
- Incl. 0.5 m connection cable in white (double-shielded)
- Maximum continuous voltage, TV connection 72 V DC / 1.5 A (25 °C)
- Limit frequency: type 2.5 GHz (75 Ohm system)

Note: The technical data in the table below refers to the power supply.

| FC-SAT-D | |
|-----------------------------------|--------------|
| Nominal voltage | U_N 230 V |
| Max. continuous operating voltage | U_C 275 V |
| SPD to EN 61643-11 | Type 3 |
| SPD to IEC 61643-11 | Class III |
| Lightning protection zone LPZ | 2→3 |
| Nominal discharge current (8/20) | I_n 3 kA |
| Protection level (L-N) | < 1,2 kV |
| Protection level (N-PE) | < 1,5 kV |
| Maximum back-up fuse | 16 A |
| Response time | t_A <25 ns |

Connection options

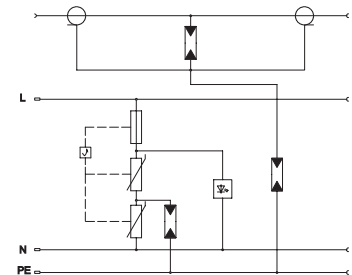



FineController FC-D for protective contact socket

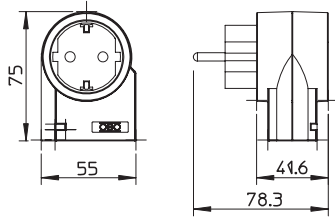

Type 3 surge protective device to EN 61643-11, intended for use in protective contact sockets.

- Adapter connector
- Cut-off unit and function display
- With increased touch protection

| Type | Country version | Colour | Pack Piece | Weight kg/100 pc. | Item no. |
|------|-----------------|------------|------------|-------------------|----------|
| FC-D | EN | Pure white | 1 | 11.000 | 5092800 |

Connection options

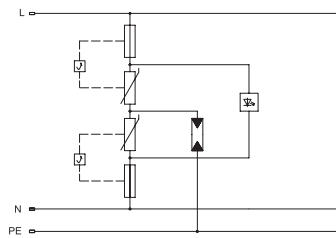

| FC-D | |
|-----------------------------------|--------------|
| Nominal voltage | U_N 230 V |
| Max. continuous operating voltage | U_C 275 V |
| SPD to EN 61643-11 | Type 3 |
| SPD to IEC 61643-11 | Class III |
| Lightning protection zone LPZ | 2→3 |
| Nominal discharge current (8/20) | I_n 3 kA |
| Protection level (L-N) | < 1,2 kV |
| Protection level (N-PE) | < 1,5 kV |
| Maximum back-up fuse | 16 A |
| Response time | t_A <25 ns |



FineController FC-TAE for telephone systems and terminals

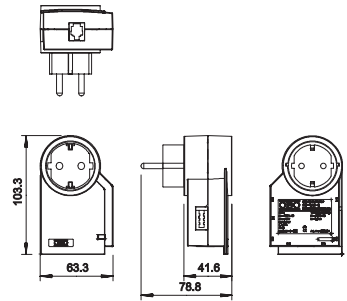

| Type | Country version | Colour | Pack Piece | Weight kg/100 pc. | Item no. |
|----------|-----------------|------------|------------|-------------------|----------|
| FC-TAE-D | EN | Pure white | 1 | 18.000 | 5092824 |

Type 3 combined surge protection to EN 61643-11, designed for use in telephone systems with TAE connection (telephones upstream of the NTBA/DSL splitter).

- Adapter connector
- Cut-off unit and function display
- With increased contact protection
- Incl. 0.5 m connection cable TAE / RJ11
- Maximum continuous voltage, TAE connection 200 V DC / 1.5 A (25 °C)
- Limit frequency: type 4 MHz / VDSL up to 46 MBit/s

Note: The technical data in the table below refers to the power supply.

| FC-TAE-D | |
|-----------------------------------|--------------|
| Nominal voltage | U_N 230 V |
| Max. continuous operating voltage | U_C 275 V |
| SPD to EN 61643-11 | Type 3 |
| SPD to IEC 61643-11 | Class III |
| Lightning protection zone LPZ | 2→3 |
| Nominal discharge current (8/20) | I_n 3 kA |
| Protection level (L-N) | < 1,2 kV |
| Protection level (N-PE) | < 1,5 kV |
| Maximum back-up fuse | 16 A |
| Response time | t_A <25 ns |

Connection options

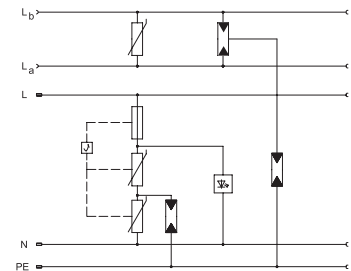



FineController FC-TV for video, TV and hi-fi systems

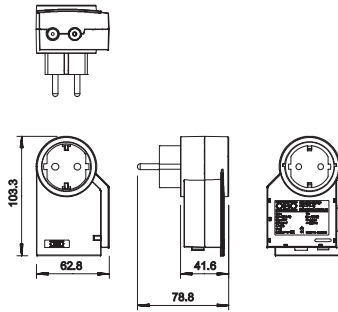

Type 3 combined surge protection to EN 61643-11, designed for use on Schuko sockets and video, TV and hi-fi systems with IEC adapter.

- Adapter connector
- Cut-off unit and function display
- With increased contact protection
- Incl. 0.5 m connection cable in white (double-shielded)
- Maximum continuous voltage, TV connection 72 V DC / 1.5 A (25 °C)
- Limit frequency: type 2.5 GHz (75 Ohm system)

Note: The technical data in the table below refers to the power supply.

| Type | Country version | Colour | Pack Piece | Weight kg/100 pc. | Item no. |
|---------|-----------------|------------|------------|-------------------|----------|
| FC-TV-D | EN | Pure white | 1 | 17.000 | 5092808 |

Connection options

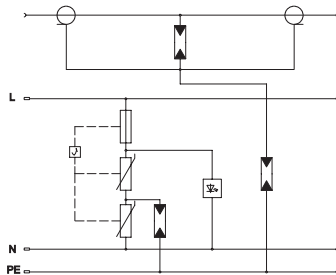

FC-TV-D

| | | |
|-----------------------------------|-------|-----------|
| Nominal voltage | U_N | 230 V |
| Max. continuous operating voltage | U_C | 275 V |
| SPD to EN 61643-11 | | Type 3 |
| SPD to IEC 61643-11 | | Class III |
| Lightning protection zone LPZ | | 2→3 |
| Nominal discharge current (8/20) | I_n | 3 kA |
| Protection level (L-N) | | < 1,2 kV |
| Protection level (N-PE) | | < 1,5 kV |
| Maximum back-up fuse | | 16 A |
| Response time | t_A | <25 ns |



FineController FC-ISDN for ISDN telephone systems and terminals

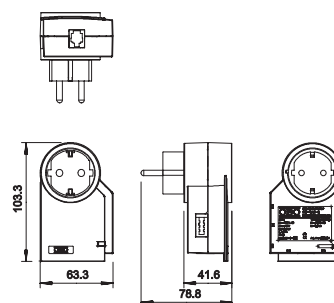

| Type | Country version | Colour | Pack Piece | Weight kg/100 pc. | Item no. |
|-----------|-----------------|------------|------------|-------------------|----------|
| FC-ISDN-D | EN | Pure white | 1 | 18.000 | 5092812 |

Type 3 combined surge protection to EN 61643-11 designed for use in ISDN / DSS 1 telephone systems and terminals.

- Adapter connector
- Cut-off unit and function display
- With increased contact protection
- Incl. 0.5 m connection cable RJ12
- Maximum continuous voltage, ISDN connection 6 V DC / 1.5 A (25 °C)
- Limit frequency: type 300 kHz

Note: The technical data in the table below refers to the power supply.

| FC-ISDN-D | |
|-----------------------------------|--------------|
| Nominal voltage | U_N 230 V |
| Max. continuous operating voltage | U_C 275 V |
| SPD to EN 61643-11 | Type 3 |
| SPD to IEC 61643-11 | Class III |
| Lightning protection zone LPZ | 2-3 |
| Nominal discharge current (8/20) | I_n 3 kA |
| Protection level (L-N) | < 1,2 kV |
| Protection level (N-PE) | < 1,5 kV |
| Maximum back-up fuse | 16 A |
| Response time | t_A <25 ns |

Connection options

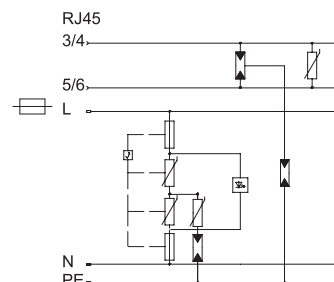



FineController FC-RJ-D for telephone systems with RJ12

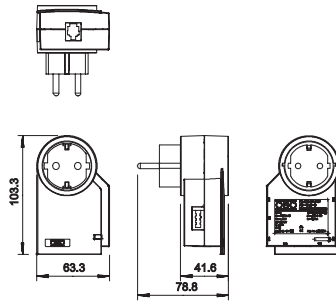

Type 3 combined surge protection to EN 61643-11 designed for use in telephone systems and terminals with RJ12 connection.

- Adapter connector
- Cut-off unit and function display
- With increased contact protection
- Incl. 0.5 m connection cable RJ12
- Maximum continuous voltage, RJ connection 200 V DC / 1.5 A (25 °C)
- Limit frequency: type 4 MHz / DSL-compatible

Note: The technical data in the table below refers to the power supply.

| Type | Country version | Colour | Pack Piece | Weight kg/100 pc. | Item no. |
|---------|-----------------|------------|------------|-------------------|----------|
| FC-RJ-D | EN | Pure white | 1 | 18.000 | 5092828 |

Connection options

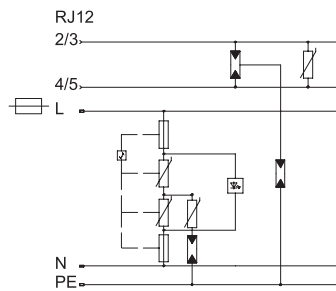

FC-RJ-D

| | | |
|-----------------------------------|-------|-----------|
| Nominal voltage | U_N | 230 V |
| Max. continuous operating voltage | U_C | 275 V |
| SPD to EN 61643-11 | | Type 3 |
| SPD to IEC 61643-11 | | Class III |
| Lightning protection zone LPZ | | 2→3 |
| Nominal discharge current (8/20) | I_n | 3 kA |
| Protection level (L-N) | | < 1,2 kV |
| Protection level (N-PE) | | < 1,5 kV |
| Maximum back-up fuse | | 16 A |
| Response time | t_A | <25 ns |



Surge protective device CNS 3 D

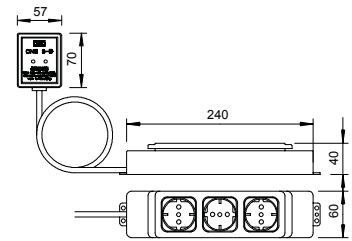

| Type | Country version | Colour | Connection cable length m | Pack Piece | Weight kg/100 pc. | Item no. |
|-----------|-----------------|--------|---------------------------|------------|-------------------|----------|
| CNS 3-D-D | EN | Black | 2 | 1 | 65.000 | 5092701 |

Surge protective device, type 3, to DIN EN 61643-11, intended for use in protective contact sockets.

- With visual and audible signalling, function display
- 3-way socket
- Length of connection cable: 2 m
- Y circuit for high electrical safety

Application: For example, the protection of PCs, printers, copiers, fax machines, etc.

CNS 3-D-D

| | | |
|-----------------------------------|-------|-----------|
| Nominal voltage | U_N | 230 V |
| Max. continuous operating voltage | U_C | 255 V |
| SPD to EN 61643-11 | | Type 3 |
| SPD to IEC 61643-11 | | Class III |
| Lightning protection zone LPZ | | 2→3 |
| Nominal discharge current (8/20) | I_n | 2.5 kA |
| Protection level (L-N) | | < 1,0 kV |
| Protection level (N-PE) | | < 1,5 kV |
| Maximum back-up fuse | | 16 A |
| Response time | t_A | <25 ns |

Connection options

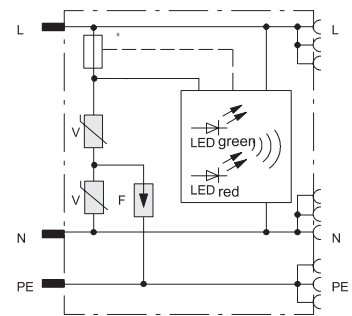



FRD/FLD family

Basic and combination protection for two-core systems



- High arresting capacity
- Low noise
- Universal application
- Simple mounting using screwless terminals
- High bandwidth
- UL-listed

The use of lightning barriers in two-core wire systems is commonplace. These surge protective devices are used from telecommunication cables through bus systems up to measurement and control technology. Surge protection technology allows flexible protection for all kinds of applications. All the devices have both a low protection level and a high arresting capacity.



Combination protection for two-core systems with HF applications 5 V

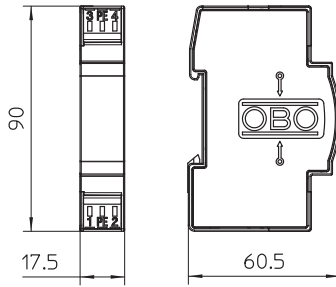

Surge protection for use in measuring, control and regulation systems.

- Basic, medium and fine protection
- Two-stage protection circuit with high lightning current carrying capacity
- High transmission frequency up to 100 MHz
- Suitable for all bus systems (e.g. Profibus)
- With installation-friendly, screwless connection terminals
- In space-saving 17.5 mm grid

Application: Multipurpose use on any 35 mm DIN profile rail in every commercially available distribution housing.

| Type | Max. continuous voltage AC V | Max. continuous voltage DC V | Number of poles | Connection system | Pack Piece | Weight kg/100 pc. | Item no. |
|----------|------------------------------|------------------------------|-----------------|-------------------|------------|-------------------|----------|
| FRD 5 HF | 4 | 6 | 2 | Terminal | 1 | 4.400 | 5098571 |

Connection options

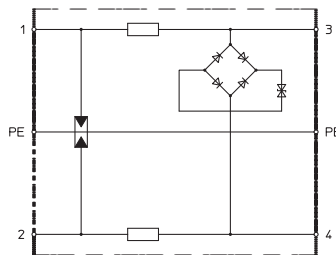

| FRD 5 HF | |
|--------------------------------------|---------------------------------|
| Maximum continuous voltage AC | U_c 4 V |
| Maximum continuous voltage DC | U_c 6 V |
| Category | Type 1+2+3 / D1+C2+C1 |
| Lightning protection zone LPZ | 0→3 |
| Number of poles | 2 |
| Rated current | I_L 0.45 A |
| Series resistance per wire | 2,2 Ω \pm 10 % |
| Impulse durability wire-wire | C2: 18 kV / 9 kA (8/20 μ s) |
| Impulse durability wire-earth | C2: 18 kV / 9 kA (8/20 μ s) |
| Total discharge current (8/20) | 18 kA |
| Total discharge current (10/350) | D1: 6 kA |
| Protection level wire-wire | <90 V |
| Protection level wire-earth | <650 V |
| Temperature range | ϑ -40 - +80 °C |
| Installation type | DIN rail 35 mm |
| Connection system | Terminal |
| Division unit TE (17.5 mm) | 1 |
| Protection rating | IP20 |
| Connection cross-section, flexible | 0.14 - 2.5 mm ² |
| Connection cross-section, multi-wire | 0.14 - 2.5 mm ² |
| Connection cross-section, rigid | 0.14 - 2.5 mm ² |
| Earthing via: | Terminal |
| Testing standard | IEC 61643-21 |
| Approvals | UL |

Combination protection for two-core systems with HF applications 24 V

Surge protection

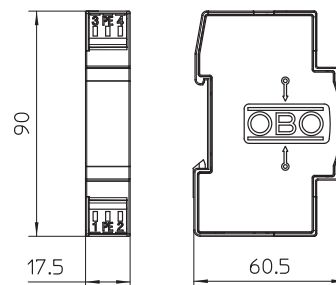

| Type | Max. continuous voltage AC V | Max. continuous voltage DC V | Number of poles | Connection system | Pack Piece | Weight kg/100 pc. | Item no. |
|-----------|------------------------------|------------------------------|-----------------|-------------------|------------|-------------------|----------|
| FRD 24 HF | 19 | 28 | 2 | Terminal | 1 | 4.400 | 5098575 |

Surge protection for use in measuring, control and regulation systems.

- Basic, medium and fine protection
- Two-stage protection circuit with high lightning current carrying capacity
- High transmission frequency up to 100 MHz
- Suitable for all bus systems (e.g. Profibus)
- With installation-friendly, screwless connection terminals
- In space-saving 17.5 mm grid

Application: Multipurpose use on any 35 mm DIN profile rail in every commercially available distribution housing.

| FRD 24 HF | |
|--------------------------------------|---------------------------------|
| Maximum continuous voltage AC | U_c 19 V |
| Maximum continuous voltage DC | U_c 28 V |
| Category | Type 1+2+3 / D1+C2+C1 |
| Lightning protection zone LPZ | 0-3 |
| Number of poles | 2 |
| Rated current | I_L 0.45 A |
| Series resistance per wire | 2,2 $\Omega \pm 10\%$ |
| Impulse durability wire-wire | C2: 18 kV / 9 kA (8/20 μ s) |
| Impulse durability wire-earth | C2: 18 kV / 9 kA (8/20 μ s) |
| Total discharge current (8/20) | 18 kA |
| Total discharge current (10/350) | D1: 6 kA |
| Protection level wire-wire | <120 V |
| Protection level wire-earth | <650 V |
| Temperature range | ϑ -40 - +80 °C |
| Installation type | DIN rail 35 mm |
| Connection system | Terminal |
| Division unit TE (17.5 mm) | 1 |
| Protection rating | IP20 |
| Connection cross-section, flexible | 0.14 - 2.5 mm ² |
| Connection cross-section, multi-wire | 0.14 - 2.5 mm ² |
| Connection cross-section, rigid | 0.14 - 2.5 mm ² |
| Earthing via: | Terminal |
| Testing standard | IEC 61643-21 |
| Approvals | UL |

Connection options

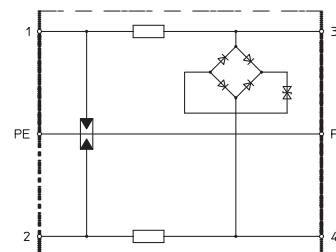



Basic protection for two-core systems with HF applications 120 V

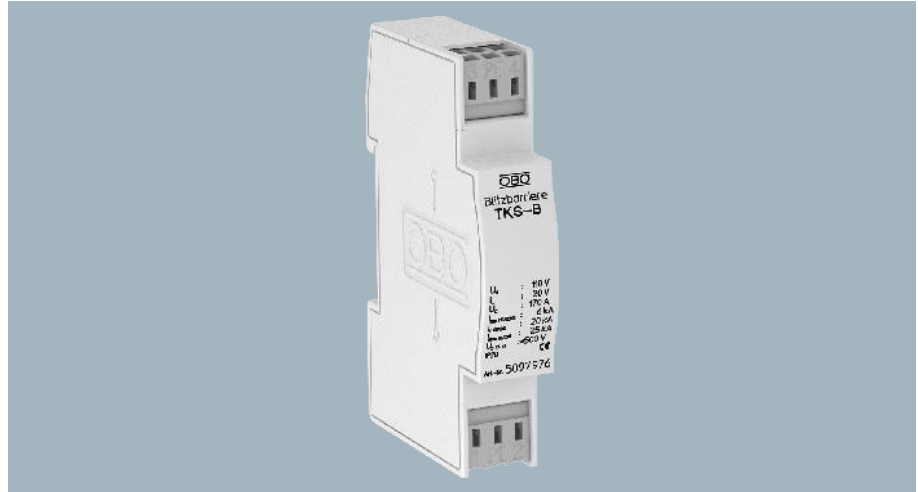
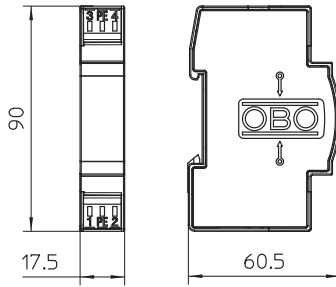

TKS-B: Surge protection for use in measuring, control and regulation systems, as well as telecommunication systems

- Basic protection for lightning protection equipotential bonding
 - High impulse arresting capacity 6 kA (10/350)
 - With installation-friendly, screwless connection terminals
 - In space-saving 17.5 mm grid
- Application: Universal use on 35 mm hat profile rail in any standard distributor housing.

| Type | Max. continuous voltage AC V | Max. continuous voltage DC V | Number of poles | Connection system | Pack Piece | Weight kg/100 pc. | Item no. |
|-------|------------------------------|------------------------------|-----------------|-------------------|------------|-------------------|----------|
| TKS-B | 120 | 170 | 2 | Terminal | 1 | 4.400 | 5097976 |

Connection options

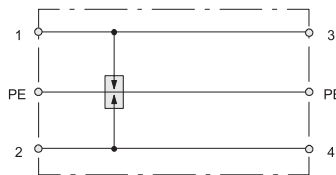

| TKS-B | |
|--------------------------------------|----------------------------|
| Maximum continuous voltage AC | U_C 120 V |
| Maximum continuous voltage DC | U_C 170 V |
| Category | Type 1+2 / D1+C2 |
| Lightning protection zone LPZ | 0→2 |
| Number of poles | 2 |
| Rated current | I_L 20 A |
| Impulse durability wire-wire | C2: 18 kV / 9 kA |
| Impulse durability wire-earth | C2: 18 kV / 9 kA |
| Total discharge current (8/20) | 18 kA |
| Total discharge current (10/350) | D1: 6 kA |
| Protection level wire-wire | <950 V |
| Protection level wire-earth | <600 V |
| Temperature range | ϑ -40 - +80 °C |
| Installation type | DIN rail |
| Connection system | Terminal |
| Division unit TE (17.5 mm) | 1 |
| Protection rating | IP20 |
| Connection cross-section, flexible | 0.14 - 2.5 mm ² |
| Connection cross-section, multi-wire | 0.14 - 2.5 mm ² |
| Connection cross-section, rigid | 0.14 - 2.5 mm ² |
| Earthing via: | Connection cable |
| Testing standard | IEC 61643-21 |

Medium and fine protection FRD for two-core systems 24 V

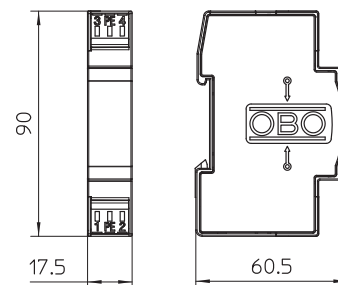

| Type | Max. continuous voltage AC V | Max. continuous voltage DC V | Number of poles | Connection system | Pack Piece | Weight kg/100 pc. | Item no. |
|--------|------------------------------|------------------------------|-----------------|-------------------|------------|-------------------|----------|
| FRD 24 | 19 | 28 | 2 | Terminal | 1 | 5.100 | 5098514 |

Surge protection for use in measurement and control technology

- Medium and fine protection
- Standard design for double core systems
- Two-stage protection circuit
- With installation-friendly, screwless connection terminals
- In space-saving 17.5 mm grid
- With ohmic decoupling in the longitudinal branch

Application: Universal use on any 35 mm DIN profile rail in every commercially available distributor housing.

| FRD 24 | |
|--------------------------------------|----------------------------------|
| Maximum continuous voltage AC | U_c 19 V |
| Maximum continuous voltage DC | U_c 28 V |
| Category | Type 1+2+3 / D1+C2+C1 |
| Lightning protection zone LPZ | 0→3 |
| Number of poles | 2 |
| Rated current | I_L 0.2 A |
| Series resistance per wire | 15 Ω ± 10 % |
| Impulse durability wire-wire | C2: 5 kV / 2,5 kA (8/20 μ s) |
| Impulse durability wire-earth | C2: 10 kV / 5 kA (8/20 μ s) |
| Total discharge current (8/20) | 10 kA |
| Total discharge current (10/350) | D1: 3 kA |
| Protection level wire-wire | <60 V |
| Protection level wire-earth | <600 V |
| Temperature range | ϑ -40 - +80 °C |
| Installation type | DIN rail 35 mm |
| Connection system | Terminal |
| Division unit TE (17.5 mm) | 1 |
| Protection rating | IP20 |
| Connection cross-section, flexible | 0.14 - 2.5 mm ² |
| Connection cross-section, multi-wire | 0.14 - 2.5 mm ² |
| Connection cross-section, rigid | 0.14 - 2.5 mm ² |
| Earthing via: | Terminal |
| Testing standard | IEC 61643-21 |
| Approvals | UL |

Connection options

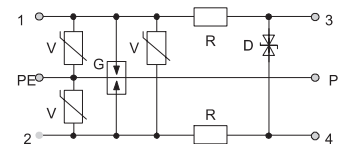



Medium and fine protection FRD for two-core systems 48 V

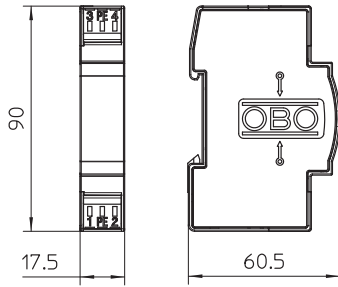

Surge protection for use in measurement and control technology

- Medium and fine protection
- Standard design for double core systems
- Two-stage protection circuit
- With installation-friendly, screwless connection terminals
- In space-saving 17.5 mm grid
- With ohmic decoupling in the longitudinal branch

Application: Universal use on any 35 mm DIN profile rail in every commercially available distributor housing.

| Type | Max. continuous voltage AC V | Max. continuous voltage DC V | Number of poles | Connection system | Pack Piece | Weight kg/100 pc. | Item no. |
|--------|------------------------------|------------------------------|-----------------|-------------------|------------|-------------------|----------|
| FRD 48 | 37 | 53 | 2 | Terminal | 1 | 5.100 | 5098522 |

Connection options

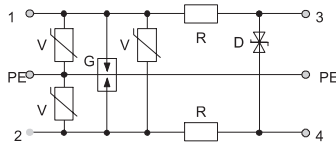

| FRD 48 | |
|--------------------------------------|----------------------------------|
| Maximum continuous voltage AC | U_c 37 V |
| Maximum continuous voltage DC | U_c 53 V |
| Category | Type 1+2+3 / D1+C2+C1 |
| Lightning protection zone LPZ | 0→3 |
| Number of poles | 2 |
| Rated current | I_L 0.2 A |
| Series resistance per wire | 15 Ω \pm 10 % |
| Impulse durability wire-wire | C2: 5 kV / 2,5 kA (8/20 μ s) |
| Impulse durability wire-earth | C2: 10 kV / 5 kA (8/20 μ s) |
| Total discharge current (8/20) | 10 kA |
| Total discharge current (10/350) | D1: 3 kA |
| Protection level wire-wire | <140 V |
| Protection level wire-earth | <600 V |
| Temperature range | ϑ -40 - +80 °C |
| Installation type | DIN rail 35 mm |
| Connection system | Terminal |
| Division unit TE (17.5 mm) | 1 |
| Protection rating | IP20 |
| Connection cross-section, flexible | 0.14 - 2.5 mm ² |
| Connection cross-section, multi-wire | 0.14 - 2.5 mm ² |
| Connection cross-section, rigid | 0.14 - 2.5 mm ² |
| Earthing via: | Terminal |
| Testing standard | IEC 61643-21 |
| Approvals | UL |

Medium and fine protection FRD for two-core systems 110 V

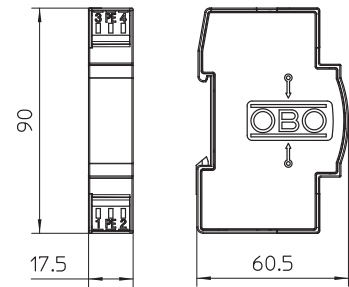

| Type | Max. continuous voltage AC V | Max. continuous voltage DC V | Number of poles | Connection system | Pack Piece | Weight kg/100 pc. | Item no. |
|---------|------------------------------|------------------------------|-----------------|-------------------|------------|-------------------|----------|
| FRD 110 | 86 | 122 | 2 | Terminal | 1 | 5.100 | 5098557 |

Surge protection for use in measurement and control technology

- Medium and fine protection
- Standard design for double core systems
- Two-stage protection circuit
- With installation-friendly, screwless connection terminals
- In space-saving 17.5 mm grid
- With ohmic decoupling in the longitudinal branch

Application: Universal use on any 35 mm DIN profile rail in every commercially available distributor housing.

| FRD 110 | |
|--------------------------------------|----------------------------------|
| Maximum continuous voltage AC | U_c 86 V |
| Maximum continuous voltage DC | U_c 122 V |
| Category | Type 1+2+3 / D1+C2+C1 |
| Lightning protection zone LPZ | 0→3 |
| Number of poles | 2 |
| Rated current | I_L 0.2 A |
| Series resistance per wire | 15 Ω \pm 10 % |
| Impulse durability wire-wire | C2: 5 kV / 2,5 kA (8/20 μ s) |
| Impulse durability wire-earth | C2: 10 kV / 5 kA |
| Total discharge current (8/20) | 10 kA |
| Total discharge current (10/350) | D1: 3 kA |
| Protection level wire-wire | <300 V |
| Protection level wire-earth | <600 V |
| Temperature range | ϑ -40 - +80 °C |
| Installation type | DIN rail 35 mm |
| Connection system | Terminal |
| Division unit TE (17.5 mm) | 1 |
| Protection rating | IP20 |
| Connection cross-section, flexible | 0.14 - 2.5 mm ² |
| Connection cross-section, multi-wire | 0.14 - 2.5 mm ² |
| Connection cross-section, rigid | 0.14 - 2.5 mm ² |
| Earthing via: | Terminal |
| Testing standard | IEC 61643-21 |
| Approvals | UL |

Connection options

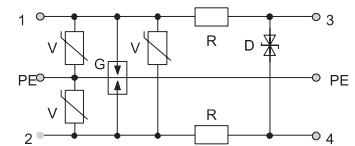



Medium and fine protection FLD for two-core systems 5 V

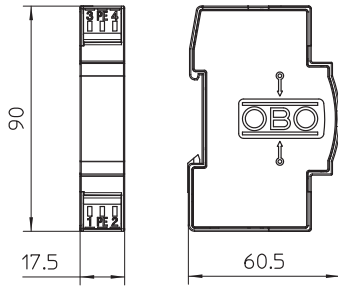

Surge protection for use in measurement and control technology

- Medium and fine protection
- Standard design for single core systems
- Two-stage protection circuit
- With installation-friendly, screwless connection terminals
- In space-saving 17.5 mm grid
- With inductive decoupling in the longitudinal branch

Application: Universal use on any 35 mm DIN profile rail in every commercially available distributor housing.

| Type | Max. continuous voltage AC V | Max. continuous voltage DC V | Number of poles | Connection system | Pack Piece | Weight kg/100 pc. | Item no. |
|--------------|------------------------------|------------------------------|-----------------|-------------------|------------|-------------------|----------------|
| FLD 5 | 5 | 8 | 2 | Terminal | 1 | 5.200 | 5098600 |

Connection options

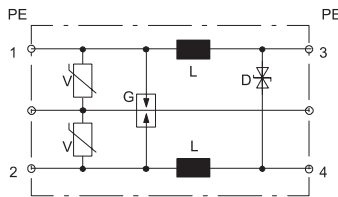

| FLD 5 | |
|--------------------------------------|----------------------------------|
| Maximum continuous voltage AC | U_c 5 V |
| Maximum continuous voltage DC | U_c 8 V |
| Category | Type 1+2+3 / D1+C2+C1 |
| Lightning protection zone LPZ | 0→3 |
| Number of poles | 2 |
| Rated current | I_L 1 A |
| Series inductivity per wire | 120 μ H \pm 20 % |
| Impulse durability wire-wire | C1: 1 kV / 0,5 kA (8/20 μ s) |
| Impulse durability wire-earth | C2: 10 kV / 5 kA (8/20 μ s) |
| Total discharge current (8/20) | 10 kA |
| Total discharge current (10/350) | D1: 3 kA |
| Protection level wire-wire | <15 V |
| Protection level wire-earth | <600 V |
| Temperature range | ϑ -40 - +80 °C |
| Installation type | DIN rail 35 mm |
| Connection system | Terminal |
| Division unit TE (17.5 mm) | 1 |
| Protection rating | IP20 |
| Connection cross-section, flexible | 0.14 - 2.5 mm ² |
| Connection cross-section, multi-wire | 0.14 - 2.5 mm ² |
| Connection cross-section, rigid | 0.14 - 2.5 mm ² |
| Earthing via: | Terminal |
| Testing standard | IEC 61643-21 |
| Approvals | UL |

Medium and fine protection FLD for two-core systems 12 V

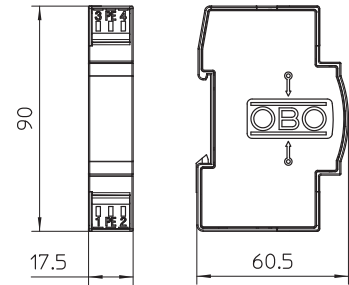

| Type | Max. continuous voltage AC V | Max. continuous voltage DC V | Number of poles | Connection system | Pack Piece | Weight kg/100 pc. | Item no. |
|---------------|------------------------------|------------------------------|-----------------|-------------------|------------|-------------------|----------------|
| FLD 12 | 9 | 13 | 2 | Terminal | 1 | 5.200 | 5098603 |

Surge protection for use in measurement and control technology

- Medium and fine protection
- Standard design for single core systems
- Two-stage protection circuit
- With installation-friendly, screwless connection terminals
- In space-saving 17.5 mm grid
- With inductive decoupling in the longitudinal branch

Application: Universal use on any 35 mm DIN profile rail in every commercially available distributor housing.

| FLD 12 | |
|--------------------------------------|----------------------------------|
| Maximum continuous voltage AC | U_c 9 V |
| Maximum continuous voltage DC | U_c 13 V |
| Category | Type 1+2+3 / D1+C2+C1 |
| Lightning protection zone LPZ | 0→3 |
| Number of poles | 2 |
| Rated current | I_L 1 A |
| Series inductivity per wire | 120 μ H \pm 20 % |
| Impulse durability wire-wire | C1: 1 kV / 0,5 kA (8/20 μ s) |
| Impulse durability wire-earth | C2: 10 kV / 5 kA (8/20 μ s) |
| Total discharge current (8/20) | 10 kA |
| Total discharge current (10/350) | D1: 3 kA |
| Protection level wire-wire | <30 V |
| Protection level wire-earth | <600 V |
| Temperature range | ϑ -40 - +80 °C |
| Installation type | DIN rail 35 mm |
| Connection system | Terminal |
| Division unit TE (17.5 mm) | 1 |
| Protection rating | IP20 |
| Connection cross-section, flexible | 0.14 - 2.5 mm ² |
| Connection cross-section, multi-wire | 0.14 - 2.5 mm ² |
| Connection cross-section, rigid | 0.14 - 2.5 mm ² |
| Earthing via: | Terminal |
| Testing standard | IEC 61643-21 |
| Approvals | UL |

Connection options

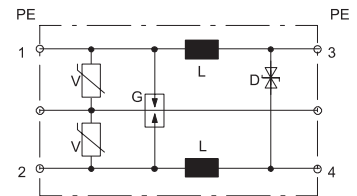



Medium and fine protection FLD for two-core systems 24 V

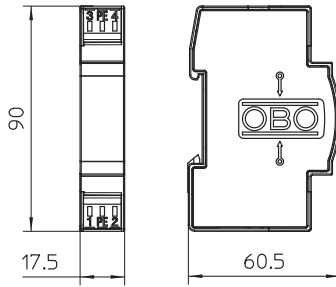

Surge protection for use in measurement and control technology

- Medium and fine protection
- Standard design for single core systems
- Two-stage protection circuit
- With installation-friendly, screwless connection terminals
- In space-saving 17.5 mm grid
- With inductive decoupling in the longitudinal branch

Application: Universal use on any 35 mm DIN profile rail in every commercially available distributor housing.

| Type | Max. continuous voltage AC V | Max. continuous voltage DC V | Number of poles | Connection system | Pack Piece | Weight kg/100 pc. | Item no. |
|---------------|------------------------------|------------------------------|-----------------|-------------------|------------|-------------------|----------------|
| FLD 24 | 19 | 28 | 2 | Terminal | 1 | 5.200 | 5098611 |

Connection options

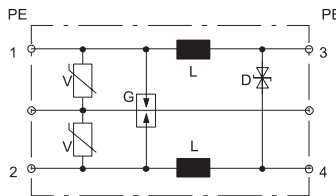

| FLD 24 | |
|--------------------------------------|----------------------------------|
| Maximum continuous voltage AC | U_c 19 V |
| Maximum continuous voltage DC | U_c 28 V |
| Category | Type 1+2+3 / D1+C2+C1 |
| Lightning protection zone LPZ | 0-3 |
| Number of poles | 2 |
| Rated current | I_L 1 A |
| Series inductivity per wire | 120 μ H \pm 20 % |
| Impulse durability wire-wire | C2: 5 kV / 2,5 kA (8/20 μ s) |
| Impulse durability wire-earth | C2: 10 kV / 5 kA (8/20 μ s) |
| Total discharge current (8/20) | 10 kA |
| Total discharge current (10/350) | D1: 3 kA |
| Protection level wire-wire | <60 V |
| Protection level wire-earth | <600 V |
| Temperature range | ϑ -40 - +80 °C |
| Installation type | DIN rail 35 mm |
| Connection system | Terminal |
| Division unit TE (17.5 mm) | 1 |
| Protection rating | IP20 |
| Connection cross-section, flexible | 0.14 - 2.5 mm ² |
| Connection cross-section, multi-wire | 0.14 - 2.5 mm ² |
| Connection cross-section, rigid | 0.14 - 2.5 mm ² |
| Earthing via: | Terminal |
| Testing standard | IEC 61643-21 |
| Approvals | UL |

Medium and fine protection FLD for two-core systems 48 V

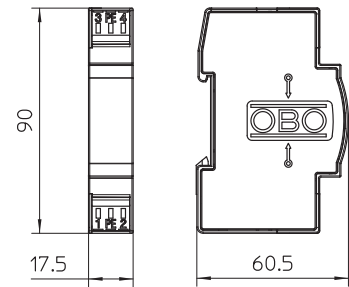

| Type | Max. continuous voltage AC V | Max. continuous voltage DC V | Number of poles | Connection system | Pack Piece | Weight kg/100 pc. | Item no. |
|---------------|------------------------------|------------------------------|-----------------|-------------------|------------|-------------------|----------------|
| FLD 48 | 37 | 53 | 2 | Terminal | 1 | 5.200 | 5098630 |

Surge protection for use in measurement and control technology

- Medium and fine protection
- Standard design for single core systems
- Two-stage protection circuit
- With installation-friendly, screwless connection terminals
- In space-saving 17.5 mm grid
- With inductive decoupling in the longitudinal branch

Application: Universal use on any 35 mm DIN profile rail in every commercially available distributor housing.

| FLD 48 | |
|--------------------------------------|----------------------------------|
| Maximum continuous voltage AC | U_c 37 V |
| Maximum continuous voltage DC | U_c 53 V |
| Category | Type 1+2+3 / D1+C2+C1 |
| Lightning protection zone LPZ | 0→3 |
| Number of poles | 2 |
| Rated current | I_L 1 A |
| Series inductivity per wire | 120 μ H \pm 20 % |
| Impulse durability wire-wire | C2: 5 kV / 2,5 kA (8/20 μ s) |
| Impulse durability wire-earth | C2: 10 kV / 5 kA (8/20 μ s) |
| Total discharge current (8/20) | 10 kA |
| Total discharge current (10/350) | D1: 3 kA |
| Protection level wire-wire | <140 V |
| Protection level wire-earth | <600 V |
| Temperature range | ϑ -40 - +80 °C |
| Installation type | DIN rail 35 mm |
| Connection system | Terminal |
| Division unit TE (17.5 mm) | 1 |
| Protection rating | IP20 |
| Connection cross-section, flexible | 0.14 - 2.5 mm ² |
| Connection cross-section, multi-wire | 0.14 - 2.5 mm ² |
| Connection cross-section, rigid | 0.14 - 2.5 mm ² |
| Earthing via: | Terminal |
| Testing standard | IEC 61643-21 |
| Approvals | UL |

Connection options

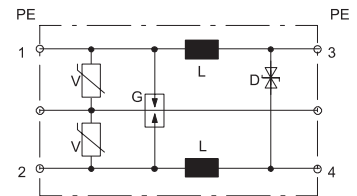



Medium and fine protection FLD for two-core systems 110 V

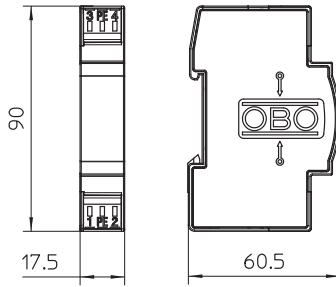

Surge protection for use in measurement and control technology

- Medium and fine protection
- Standard design for single core systems
- Two-stage protection circuit
- With installation-friendly, screwless connection terminals
- In space-saving 17.5 mm grid
- With inductive decoupling in the longitudinal branch

Application: Universal use on any 35 mm DIN profile rail in every commercially available distributor housing.

| Type | Max. continuous voltage AC V | Max. continuous voltage DC V | Number of poles | Connection system | Pack Piece | Weight kg/100 pc. | Item no. |
|----------------|------------------------------|------------------------------|-----------------|-------------------|------------|-------------------|----------------|
| FLD 110 | 86 | 122 | 2 | Terminal | 1 | 5.200 | 5098646 |

Connection options

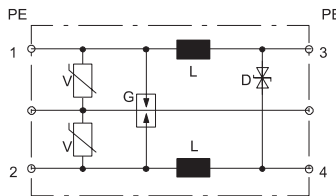

| FLD 110 | |
|--------------------------------------|----------------------------------|
| Maximum continuous voltage AC | U_c 86 V |
| Maximum continuous voltage DC | U_c 122 V |
| Category | Type 1+2+3 / D1+C2+C1 |
| Lightning protection zone LPZ | 0→3 |
| Number of poles | 2 |
| Rated current | I_L 1 A |
| Series inductivity per wire | 120 μ H \pm 20 % |
| Impulse durability wire-wire | C1: 1 kV / 0,5 kA (8/20 μ s) |
| Impulse durability wire-earth | C2: 10 kV / 5 kA (8/20 μ s) |
| Total discharge current (8/20) | 10 kA |
| Total discharge current (10/350) | D1: 3 kA |
| Protection level wire-wire | <300 V |
| Protection level wire-earth | <600 V |
| Temperature range | ϑ -40 - +80 °C |
| Installation type | DIN rail 35 mm |
| Connection system | Terminal |
| Division unit TE (17.5 mm) | 1 |
| Protection rating | IP20 |
| Connection cross-section, flexible | 0.14 - 2.5 mm ² |
| Connection cross-section, multi-wire | 0.14 - 2.5 mm ² |
| Connection cross-section, rigid | 0.14 - 2.5 mm ² |
| Earthing via: | Terminal |
| Testing standard | IEC 61643-21 |
| Approvals | UL |

MDP family

MCR protection for multi-wire systems (testable)



- Protection device for multi-wire systems (4-pole)
- Direct shield earthing
- Easy-mounting, screwless connection terminals
- Space-saving width of just 8.7 mm
- Versions with nominal currents up to 10 A
- High frequency bandwidth up to 100 MHz
- UL-listed

Besides the high current capacity, the lightning barriers of type MDP offer a narrow installation width of just 8.7 mm. A separate screen connection permits screen attachment on both sides of the equipotential bonding, thus optimising the screen effect against capacitive and inductive couplings. Depen-

ding on the version, a nominal current of up to 10 A can be applied to the devices, meaning that they are thus ideally suited to use in special applications, such as slip ring transmitters or heating systems in wind power systems. When installed, all the MDPs can be checked using LifeControl.



MCR protection for 2-pole power supply, 12 V

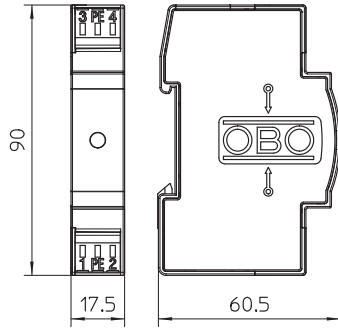

Surge protection device/fine protection type 3 to EN 61643-11

- Suitable for DC and AC voltage systems
- With visual function display
- With installation-friendly, screwless connection terminals
- In a space-saving 17.5 mm grid
- Y circuit

Application: Universal use on 35 mm DIN profile rail in every normal commercially available distributor housing.

| Type | Highest continuous voltage V | Pack Piece | Weight kg/100 pc. | Item no. |
|------------|------------------------------|------------|-------------------|----------|
| VF12-AC DC | 13.5 | 1 | 9.000 | 5097453 |

Connection options

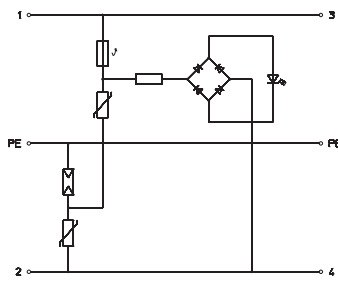

VF12-AC DC

| | | |
|--------------------------------------|-------------------|----------------------------|
| U max AC | U _c AC | 13.5 V |
| U max DC | U _c DC | 18 V |
| SPD to EN 61643-11 | | Type 3 |
| SPD to IEC 61643-11 | | Class III |
| Lightning protection zone LPZ | | 2→3 |
| Nominal discharge current (8/20) | I _n | 0,7 kA |
| Maximum discharge current (8/20 μs) | I _{max} | 2 kA |
| Rated current | I _L | 20 A |
| Protection level wire-wire | | <110 V |
| Protection level wire-earth | | <1200 V |
| Response time | t _A | <25 ns |
| Temperature range | ϑ | -40 - +80 °C |
| Protection rating | | IP 20 |
| Division unit TE (17.5 mm) | | 1 |
| Connection cross-section, rigid | | 0.14 - 2.5 mm ² |
| Connection cross-section, multi-wire | | 0.14 - 2.5 mm ² |
| Connection cross-section, flexible | | 0.14 - 2.5 mm ² |

MCR protection for 2-pole for power supply, 24 V

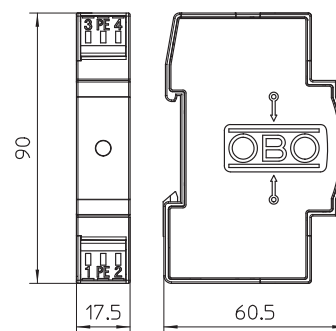

| Type | Highest continuous voltage V | Pack Piece | Weight kg/100 pc. | Item no. |
|------------|------------------------------|------------|-------------------|----------|
| VF24-AC/DC | 34 | 1 | 8.000 | 5097607 |

Surge protection device/fine protection type 3 to EN 61643-11

- Suitable for DC and AC voltage systems
- With visual function display
- With installation-friendly, screwless connection terminals
- In a space-saving 17.5 mm grid
- Y circuit

Application: Universal use on 35 mm DIN profile rail in every normal commercially available distributor housing.

| VF24-AC/DC | |
|--------------------------------------|----------------------------|
| U max AC | U _c AC 34 V |
| U max DC | U _c DC 46 V |
| SPD to EN 61643-11 | Type 3 |
| SPD to IEC 61643-11 | Class III |
| Lightning protection zone LPZ | 2-3 |
| Nominal discharge current (8/20) | I _n 0,7 kA |
| Maximum discharge current (8/20 μs) | I _{max} 2 kA |
| Rated current | I _L 20 A |
| Protection level wire-wire | <130 V |
| Protection level wire-earth | <1200 V |
| Response time | t _A <25 ns |
| Temperature range | ϑ -40 - +80 °C |
| Protection rating | IP 20 |
| Division unit TE (17.5 mm) | 1 |
| Connection cross-section, rigid | 0.14 - 2.5 mm ² |
| Connection cross-section, multi-wire | 0.14 - 2.5 mm ² |
| Connection cross-section, flexible | 0.14 - 2.5 mm ² |

Connection options

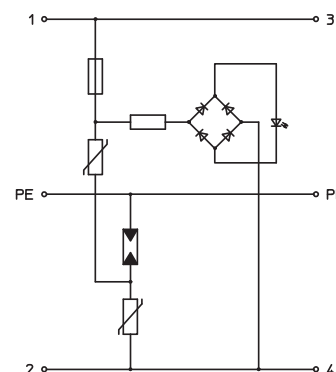



MCR protection for 2-pole for power supply, 48 V

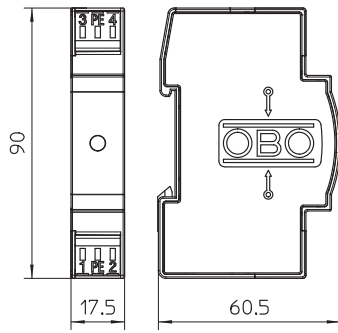

Surge protection device/fine protection type 3 to EN 61643-11

- Suitable for DC and AC voltage systems
- With visual function display
- With installation-friendly, screwless connection terminals
- In a space-saving 17.5 mm grid
- Y circuit

Application: Universal use on 35 mm DIN profile rail in every normal commercially available distributor housing.

| Type | Highest continuous voltage V | Pack Piece | Weight kg/100 pc. | Item no. |
|------------|------------------------------|------------|-------------------|----------|
| VF48-AC/DC | 60 | 1 | 8.000 | 5097615 |

Connection options

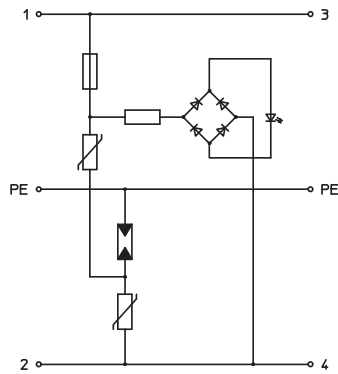

| VF48-AC/DC | |
|--------------------------------------|----------------------------|
| U max AC | U _c AC 60 V |
| U max DC | U _c DC 80 V |
| SPD to EN 61643-11 | Type 3 |
| SPD to IEC 61643-11 | Class III |
| Lightning protection zone LPZ | 2→3 |
| Nominal discharge current (8/20) | I _n 0,7 kA |
| Maximum discharge current (8/20 μs) | I _{max} 2 kA |
| Rated current | I _L 20 A |
| Protection level wire-wire | <220 V |
| Protection level wire-earth | <1200 V |
| Response time | t _A <25 ns |
| Temperature range | θ -40 - +80 °C |
| Protection rating | IP 20 |
| Division unit TE (17.5 mm) | 1 |
| Connection cross-section, rigid | 0.14 - 2.5 mm ² |
| Connection cross-section, multi-wire | 0.14 - 2.5 mm ² |
| Connection cross-section, flexible | 0.14 - 2.5 mm ² |

MCR protection for 2-pole for power supply, 60 V

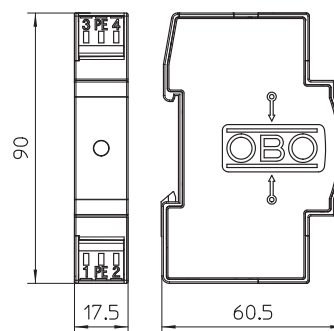

| Type | Highest continuous voltage V | Pack Piece | Weight kg/100 pc. | Item no. |
|------------|------------------------------|------------|-------------------|----------|
| VF60-AC/DC | 80 | 1 | 8.000 | 5097623 |

Surge protection device/fine protection type 3 to EN 61643-11

- Suitable for DC and AC voltage systems
- With visual function display
- With installation-friendly, screwless connection terminals
- In a space-saving 17.5 mm grid
- Y circuit

Application: Universal use on 35 mm DIN profile rail in every normal commercially available distributor housing.

| VF60-AC/DC | |
|--------------------------------------|----------------------------|
| U max AC | U _c AC 80 V |
| U max DC | U _c DC 110 V |
| SPD to EN 61643-11 | Type 3 |
| SPD to IEC 61643-11 | Class III |
| Lightning protection zone LPZ | 2→3 |
| Nominal discharge current (8/20) | I _n 0,7 kA |
| Maximum discharge current (8/20 μs) | I _{max} 2 kA |
| Rated current | I _L 20 A |
| Protection level wire-wire | <280 V |
| Protection level wire-earth | <1200 V |
| Response time | t _A <25 ns |
| Temperature range | ϑ -40 - +80 °C |
| Protection rating | IP 20 |
| Division unit TE (17.5 mm) | 1 |
| Connection cross-section, rigid | 0.14 - 2.5 mm ² |
| Connection cross-section, multi-wire | 0.14 - 2.5 mm ² |
| Connection cross-section, flexible | 0.14 - 2.5 mm ² |

Connection options

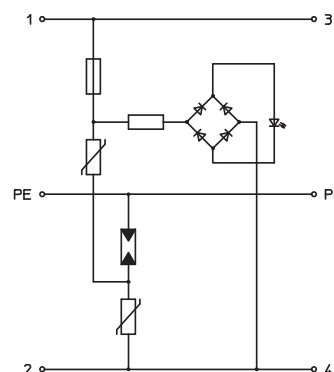



MCR protection for 2-pole for power supply, 110 V

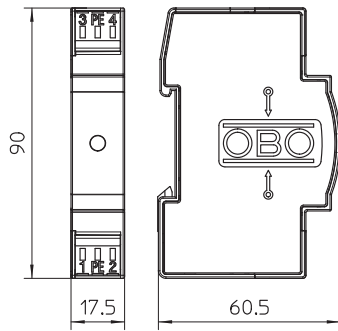

Surge protection device/fine protection type 3 to EN 61643-11

- Suitable for DC and AC voltage systems
- With visual function display
- With installation-friendly, screwless connection terminals
- In a space-saving 17.5 mm grid
- Y circuit

Application: Universal use on 35 mm DIN profile rail in every normal commercially available distributor housing.

| Type | Highest continuous voltage V | Pack Piece | Weight kg/100 pc. | Item no. |
|-------------|------------------------------|------------|-------------------|----------|
| VF110-AC DC | 150 | 1 | 8.000 | 5097631 |

Connection options

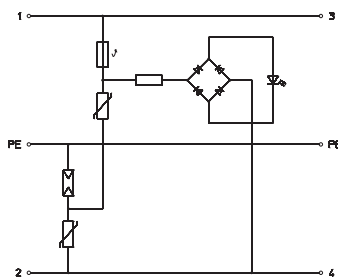

| VF110-AC DC | |
|--------------------------------------|----------------------------|
| U max AC | U _c AC 150 V |
| U max DC | U _c DC 200 V |
| SPD to EN 61643-11 | Type 3 |
| SPD to IEC 61643-11 | Class III |
| Lightning protection zone LPZ | 2→3 |
| Nominal discharge current (8/20) | I _n 2 kA |
| Maximum discharge current (8/20 μs) | I _{max} 6.5 kA |
| Rated current | I _L 20 A |
| Protection level wire-wire | <500 V |
| Protection level wire-earth | <1400 V |
| Response time | t _A <25 ns |
| Temperature range | θ -40 - +80 °C |
| Protection rating | IP 20 |
| Division unit TE (17.5 mm) | 1 |
| Connection cross-section, rigid | 0.14 - 2.5 mm ² |
| Connection cross-section, multi-wire | 0.14 - 2.5 mm ² |
| Connection cross-section, flexible | 0.14 - 2.5 mm ² |

MCR protection for 2-pole for power supply, 230 V

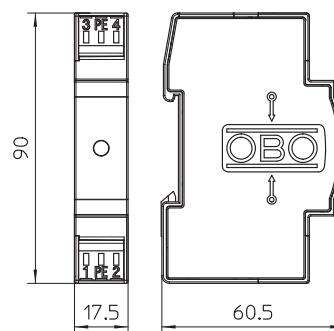

| Type | Highest continuous voltage V | Pack Piece | Weight kg/100 pc. | Item no. |
|-------------|------------------------------|------------|-------------------|----------|
| VF230-AC/DC | 255 | 1 | 8.000 | 5097650 |

Surge protection device/fine protection type 3 to EN 61643-11

- Suitable for DC and AC voltage systems
- With visual function display
- With installation-friendly, screwless connection terminals
- In a space-saving 17.5 mm grid
- Y circuit

Application: Universal use on 35 mm DIN profile rail in every normal commercially available distributor housing.

| VF230-AC/DC | |
|--------------------------------------|----------------------------|
| U max AC | U _c AC 255 V |
| U max DC | U _c DC 350 V |
| SPD to EN 61643-11 | Type 3 |
| SPD to IEC 61643-11 | Class III |
| Lightning protection zone LPZ | 2-3 |
| Nominal discharge current (8/20) | I _n 2.5 kA |
| Maximum discharge current (8/20 μs) | I _{max} 7 kA |
| Rated current | I _L 20 A |
| Protection level wire-wire | <1000 V |
| Protection level wire-earth | <1400 V |
| Response time | t _A <25 ns |
| Temperature range | θ -40 - +80 °C |
| Protection rating | IP 20 |
| Division unit TE (17.5 mm) | 1 |
| Connection cross-section, rigid | 0.14 - 2.5 mm ² |
| Connection cross-section, multi-wire | 0.14 - 2.5 mm ² |
| Connection cross-section, flexible | 0.14 - 2.5 mm ² |

Connection options

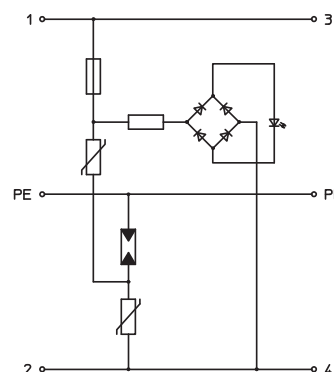



MCR protection for 2-pole for power supply with remote signalling, 12 V AC/DC

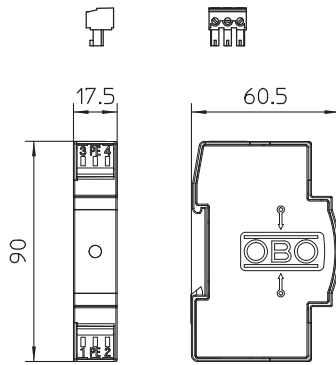

Surge protection / fine power protection, type 3, to EN 61643-11 with remote signalling

- With remote signalling, potential-free changeover contact, for function monitoring
- Suitable for DC and AC systems
- With visual function display
- With easy mounting, screwless connection terminals
- In space-saving 17.5 mm grid
- Y circuit

Application: Universal use on 35 mm DIN profile rails in any standard distributor housing.

| Type | Highest continuous voltage V | Pack Piece | Weight kg/100 pc. | Item no. |
|---------------|------------------------------|------------|-------------------|----------|
| VF12-AC/DC-FS | 13.5 | 1 | 6.400 | 5097454 |

Connection options

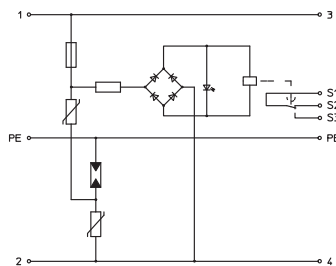

| VF12-AC/DC-FS | |
|--------------------------------------|----------------------------|
| U max AC | U _c AC 13.5 V |
| U max DC | U _c DC 18 V |
| SPD to EN 61643-11 | Type 3 |
| SPD to IEC 61643-11 | Class III |
| Lightning protection zone LPZ | 2→3 |
| Nominal discharge current (8/20) | I _n 0,7 kA |
| Maximum discharge current (8/20 μs) | I _{max} 2 kA |
| Rated current | I _L 20 A |
| Protection level wire-wire | <110 V |
| Protection level wire-earth | <1200 V |
| Response time | t _A <25 ns |
| Temperature range | θ -40 - +80 °C |
| Protection rating | IP 20 |
| Division unit TE (17.5 mm) | 1 |
| Connection cross-section, rigid | 0.14 - 2.5 mm ² |
| Connection cross-section, multi-wire | 0.14 - 2.5 mm ² |
| Connection cross-section, flexible | 0.14 - 2.5 mm ² |

MCR protection for 2-pole power supply with remote signalling, 24 V AC/DC

Surge protection

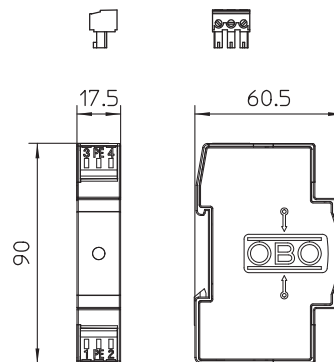

| Type | Highest continuous voltage V | Pack Piece | Weight kg/100 pc. | Item no. |
|---------------|------------------------------|------------|-------------------|----------|
| VF24-AC/DC-FS | 34 | 1 | 6.620 | 5097820 |

Surge protection / fine power protection, type 3, to EN 61643-11 with remote signalling

- With remote signalling, potential-free changeover contact, for function monitoring
- Suitable for DC and AC systems
- With visual function display
- With easy mounting, screwless connection terminals
- In space-saving 17.5 mm grid
- Y circuit

Application: Universal use on 35 mm DIN profile rails in any standard distributor housing.

| VF24-AC/DC-FS | |
|--------------------------------------|----------------------------|
| U max AC | U _{c AC} 34 V |
| U max DC | U _{c DC} 46 V |
| SPD to EN 61643-11 | Type 3 |
| SPD to IEC 61643-11 | Class III |
| Lightning protection zone LPZ | 2→3 |
| Nominal discharge current (8/20) | I _n 0,7 kA |
| Maximum discharge current (8/20 μs) | I _{max} 2 kA |
| Rated current | I _L 20 A |
| Protection level wire-wire | <160 V |
| Protection level wire-earth | <1200 V |
| Response time | t _A <25 ns |
| Temperature range | ϑ -40 - +80 °C |
| Protection rating | IP 20 |
| Division unit TE (17.5 mm) | 1 |
| Connection cross-section, rigid | 0.14 - 2.5 mm ² |
| Connection cross-section, multi-wire | 0.14 - 2.5 mm ² |
| Connection cross-section, flexible | 0.14 - 2.5 mm ² |

Connection options

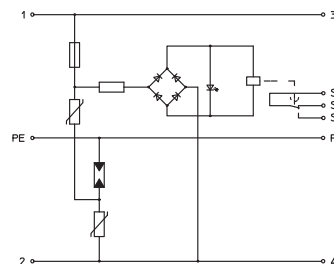



MMSR protection for 2-pole power supply with remote signalling, 48 V AC/DC

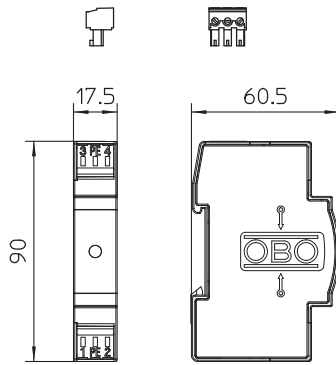

Surge protection / fine power protection, type 3, to EN 61643-11 with remote signalling

- With remote signalling, potential-free changeover contact, for function monitoring
- Suitable for DC and AC systems
- With visual function display
- With easy mounting, screwless connection terminals
- In space-saving 17.5 mm grid
- Y circuit

Application: Universal use on 35 mm DIN profile rails in any standard distributor housing.

| Type | Highest continuous voltage V | Pack Piece | Weight kg/100 pc. | Item no. |
|---------------|------------------------------|------------|-------------------|----------|
| VF48-AC/DC-FS | 60 | 1 | 6.630 | 5097822 |

Connection options

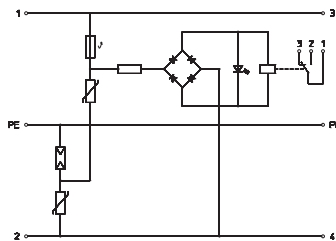

| VF48-AC/DC-FS | |
|--------------------------------------|----------------------------|
| U max AC | U _{c AC} 60 V |
| U max DC | U _{c DC} 80 V |
| SPD to EN 61643-11 | Type 3 |
| SPD to IEC 61643-11 | Class III |
| Lightning protection zone LPZ | 2→3 |
| Nominal discharge current (8/20) | I _n 0,7 kA |
| Maximum discharge current (8/20 μs) | I _{max} 2 kA |
| Rated current | I _L 20 A |
| Protection level wire-wire | <220 V |
| Protection level wire-earth | <1200 V |
| Response time | t _A <25 ns |
| Temperature range | θ -40 - +80 °C |
| Protection rating | IP 20 |
| Division unit TE (17.5 mm) | 1 |
| Connection cross-section, rigid | 0.14 - 2.5 mm ² |
| Connection cross-section, multi-wire | 0.14 - 2.5 mm ² |
| Connection cross-section, flexible | 0.14 - 2.5 mm ² |

MCR protection for 2-pole power supply with remote signalling, 230 V AC

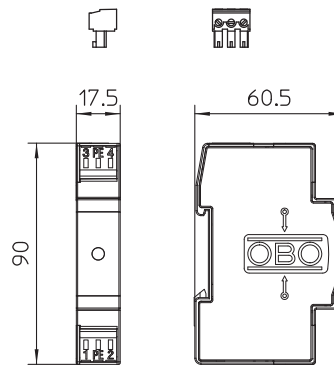

| Type | Highest continuous voltage V | Pack Piece | Weight kg/100 pc. | Item no. |
|-------------|------------------------------|------------|-------------------|----------|
| VF230-AC-FS | 255 | 1 | 6.910 | 5097858 |

Surge protection / fine power protection, type 3, to EN 61643-11 with remote signalling

- With remote signalling, potential-free changeover contact, for function monitoring
- Suitable for AC systems
- With visual function display
- With easy mounting, screwless connection terminals
- In space-saving 17.5 mm grid
- Y circuit

Application: Universal use on 35 mm DIN profile rails in any standard distributor housing.

| VF230-AC-FS | |
|--------------------------------------|----------------------------|
| U max AC | U _c AC 255 V |
| SPD to EN 61643-11 | Type 3 |
| SPD to IEC 61643-11 | Class III |
| Lightning protection zone LPZ | 2→3 |
| Nominal discharge current (8/20) | I _n 2,5 kA |
| Maximum discharge current (8/20 μs) | I _{max} 7 kA |
| Rated current | I _L 20 A |
| Protection level wire-wire | <1060 V |
| Protection level wire-earth | <1400 V |
| Response time | t _A <25 ns |
| Temperature range | ϑ -40 - +80 °C |
| Protection rating | IP 20 |
| Division unit TE (17.5 mm) | 1 |
| Connection cross-section, rigid | 0.14 - 2.5 mm ² |
| Connection cross-section, multi-wire | 0.14 - 2.5 mm ² |
| Connection cross-section, flexible | 0.14 - 2.5 mm ² |

Connection options

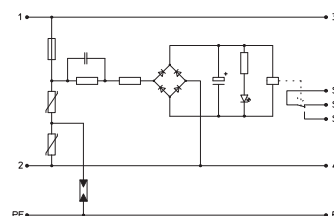



MCR protection for 2-pin for power supply with leak current-free remote signalling, 230 V AC/DC

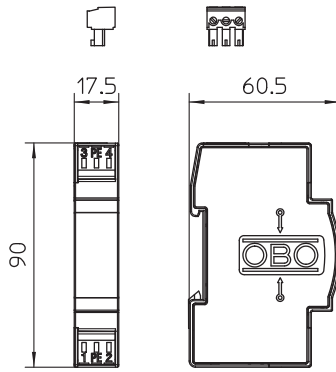

Type 3 surge protection/fine network protection to EN 61643-11

with leak current-free remote signalling

- With remote signalling: potential-free NC contact for function monitoring
- With installation-friendly, screwless connection terminals
- In space-saving 17.5 mm grid
- Y circuit

Application: Universal use on 35 mm DIN profile rails in any standard distributor housing.

| Type | U max | U max | Pack | Weight | Item no. |
|------------------|-------|-------|---------|------------------|----------|
| | AC | DC | | | |
| VF2-230-AC/DC-FS | 255 V | 350 V | 1 Piece | 6.000 kg/100 pc. | 5097939 |

Connection options

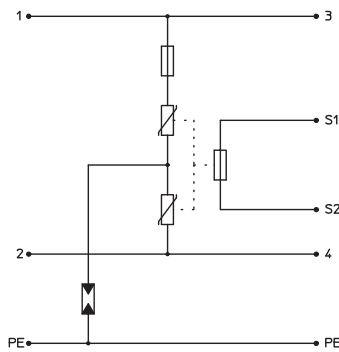

| VF2-230-AC/DC-FS | |
|--------------------------------------|----------------------------|
| U max AC | U _c AC 255 V |
| U max DC | U _c DC 350 V |
| SPD to EN 61643-11 | Type 3 |
| SPD to IEC 61643-11 | Class III |
| Lightning protection zone LPZ | 2→3 |
| Nominal discharge current (8/20) | I _n 2,5 kA |
| Maximum discharge current (8/20 μs) | I _{max} 7 kA |
| Rated current | I _L 20 A |
| Protection level wire-wire | < 1000 V |
| Protection level wire-earth | < 1400 V |
| Response time | t _A <25 ns |
| Temperature range | θ -40 - +80 °C |
| Protection rating | IP 20 |
| Division unit TE (17.5 mm) | 1 |
| Connection cross-section, rigid | 0.14 - 2.5 mm ² |
| Connection cross-section, multi-wire | 0.14 - 2.5 mm ² |
| Connection cross-section, flexible | 0.14 - 2.5 mm ² |

VF family

Protection for 2-pin power supplies



- High arresting capacity
- Low noise level
- Usable in AC/DC applications
- Simple mounting using screwless terminals

The lightning barriers of type VF are fine protection devices, used for single-phase energy technology systems. Besides the low protection level, these devices also have a visual display, which will indicate defective surge protection. If required, remote signalling is also available using a changeover contact and an NC contact.



Series protection device, 2-pole, 5 V version

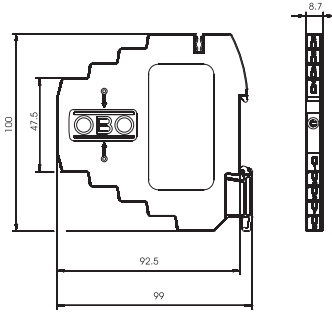

Lightning barrier with test function; 5 V version

- Nominal load current 0.58 A
- Protection device for multi-wire systems
- Direct shield earthing and screwless connection terminals
- Space-saving width of just 8.7 mm
- Protection circuit testable with Life Control
- High frequency range of 0–100 MHz
- UL-listed (4DG1)

Application: Universal use on 35 mm DIN profile rail in any standard distribution housing.

| Type | Max. continuous voltage AC V | Max. continuous voltage DC V | Number of poles | Connection system | Pack Piece | Weight kg/100 pc. | Item no. |
|-------------|------------------------------|------------------------------|-----------------|-------------------|------------|-------------------|----------|
| MDP-2 D-5-T | 7 | 10 | 2 | Terminal | 1 | 6.000 | 5098404 |

Connection options

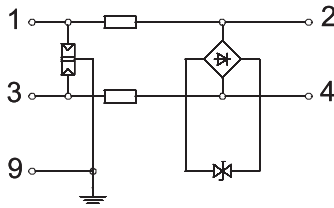

| MDP-2 D-5-T | |
|--------------------------------------|-------------------------------------|
| Maximum continuous voltage AC | U_c 7 V |
| Maximum continuous voltage DC | U_c 10 V |
| Category | Type 1+2+3 / D1+C2+C1 |
| Lightning protection zone LPZ | 0→3 |
| Number of poles | 2 |
| Rated current | I_L 0.58 A |
| Series resistance per wire | 2,35 Ω \pm 5 % |
| Impulse durability wire-wire | C1: 0,5 kV / 0,25 kA (8/20 μ s) |
| Impulse durability wire-earth | C2: 5 kV / 2,5 kA (8/20 μ s) |
| Total discharge current (8/20) | 5 kA |
| Total discharge current (10/350) | D1: 1 kA |
| Protection level wire-wire | <35 V |
| Protection level wire-earth | <800 V |
| Frequency range | 0 - 100 MHz |
| Temperature range | ϑ -40 - +80 °C |
| Installation type | DIN rail 35 mm |
| Connection system | Terminal |
| Protection rating | IP20 |
| Shielding connection available | Yes |
| Shield connection | Direct |
| Connection cross-section, flexible | 0.14 - 2.5 mm ² |
| Connection cross-section, multi-wire | 0.14 - 1.5 mm ² |
| Connection cross-section, rigid | 0.14 - 2.5 mm ² |
| Earthing via: | DIN rail |
| Testing standard | IEC 61643-21 |
| Approvals | UL |

Series protection device, 3-pole, 5 V version

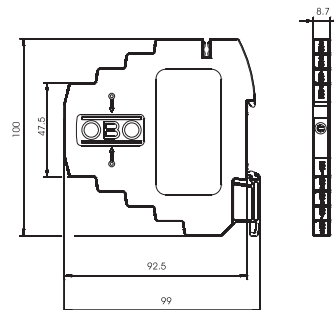

| Type | Max. continuous AC voltage V | Max. continuous DC voltage V | Number of poles | Connection system | Pack Piece | Weight kg/100 pc. | Item no. |
|-------------|------------------------------|------------------------------|-----------------|-------------------|------------|-------------------|----------|
| MDP-3 D-5-T | 7 | 10 | 3 | Terminal | 1 | 6.000 | 5098407 |

Lightning barrier with test function; 5 V version

- Nominal load current 0.58 A
- Protection device for multi-wire systems
- Direct shield earthing and screwless connection terminals
- Space-saving width of just 8.7 mm
- Protection circuit testable with Life Control
- High frequency range of 0–100 MHz
- UL-listed (4DG1)

Application: Universal use on 35 mm DIN profile rail in any standard distribution housing.

| MDP-3 D-5-T | |
|--------------------------------------|-------------------------------------|
| Maximum continuous voltage AC | U_c 7 V |
| Maximum continuous voltage DC | U_c 10 V |
| Category | Type 1+2+3 / D1+C2+C1 |
| Lightning protection zone LPZ | 0→3 |
| Number of poles | 3 |
| Rated current | I_L 0.58 A |
| Series resistance per wire | 2,35 Ω \pm 5 % |
| Impulse durability wire-wire | C1: 0,5 kV / 0,25 kA (8/20 μ s) |
| Impulse durability wire-earth | C2: 5 kV / 2,5 kA (8/20 μ s) |
| Total discharge current (8/20) | 7,5 kA |
| Total discharge current (10/350) | D1: 1,5 kA |
| Protection level wire-wire | <35 V |
| Protection level wire-earth | <800 V |
| Frequency range | 0 - 100 MHz |
| Temperature range | ϑ -40 - +80 °C |
| Installation type | DIN rail 35 mm |
| Connection system | Terminal |
| Protection rating | IP20 |
| Shielding connection available | Yes |
| Shield connection | Direct |
| Connection cross-section, flexible | 0.14 - 2.5 mm ² |
| Connection cross-section, multi-wire | 0.14 - 1.5 mm ² |
| Connection cross-section, rigid | 0.14 - 2.5 mm ² |
| Earthing via: | DIN rail |
| Testing standard | IEC 61643-21 |
| Approvals | UL |

Connection options

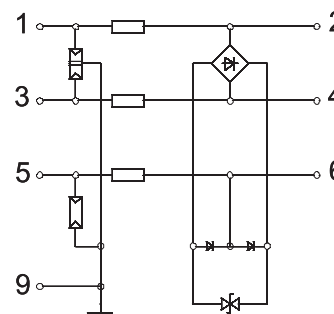



Series protection device, 4-pole, 5 V version

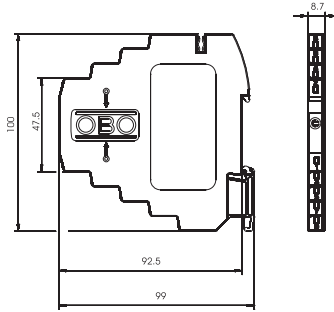

Lightning barrier with test function; 5 V version

- Nominal load current 0.58 A
- Protection device for multi-wire systems
- Direct shield earthing and screwless connection terminals
- Space-saving width of just 8.7 mm
- Protection circuit testable with Life Control
- High frequency range of 0–100 MHz
- UL-listed (4DG1)

Application: Universal use on 35 mm DIN profile rail in any standard distribution housing.

| Type | Max. continuous AC voltage V | Max. continuous DC voltage V | Number of poles | Connection system | Pack Piece | Weight kg/100 pc. | Item no. |
|-------------|------------------------------|------------------------------|-----------------|-------------------|------------|-------------------|----------|
| MDP-4 D-5-T | 7 | 10 | 4 | Terminal | 1 | 6.000 | 5098411 |

Connection options

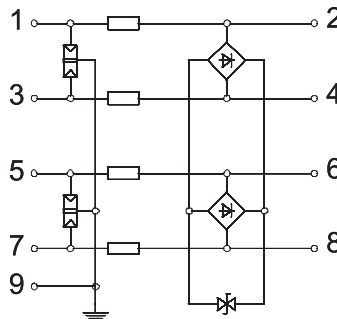

| MDP-4 D-5-T | |
|--------------------------------------|-------------------------------------|
| Maximum continuous voltage AC | U_c 7 V |
| Maximum continuous voltage DC | U_c 10 V |
| Category | Type 1+2+3 / D1+C2+C1 |
| Lightning protection zone LPZ | 0→3 |
| Number of poles | 4 |
| Rated current | I_L 0.58 A |
| Series resistance per wire | 2,35 Ω \pm 5 % |
| Impulse durability wire-wire | C1: 0,5 kV / 0,25 kA (8/20 μ s) |
| Impulse durability wire-earth | C2: 5 kV / 2,5 kA (8/20 μ s) |
| Total discharge current (8/20) | 10 kA |
| Total discharge current (10/350) | D1: 2 kA |
| Protection level wire-wire | <35 V |
| Protection level wire-earth | <800 V |
| Frequency range | 0 - 100 MHz |
| Temperature range | ϑ -40 - +80 °C |
| Installation type | DIN rail 35 mm |
| Connection system | Terminal |
| Protection rating | IP20 |
| Shielding connection available | Yes |
| Shield connection | Direct |
| Connection cross-section, flexible | 0.14 - 2.5 mm ² |
| Connection cross-section, multi-wire | 0.14 - 1.5 mm ² |
| Connection cross-section, rigid | 0.14 - 2.5 mm ² |
| Earthing via: | DIN rail |
| Testing standard | IEC 61643-21 |
| Approvals | UL |

Series protection device, 2-pole, 24 V version

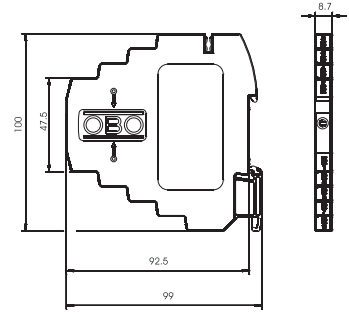

Surge protection

| Type | Max. continuous AC voltage V | Max. continuous DC voltage V | Number of poles | Connection system | Pack Piece | Weight kg/100 pc. | Item no. |
|--------------|------------------------------|------------------------------|-----------------|-------------------|------------|-------------------|----------|
| MDP-2 D-24-T | 20 | 28 | 2 | Terminal | 1 | 6.000 | 5098422 |

Lightning barrier with test function; 24 V version

- Rated load current 0.58 A
- Protection device for multi-wire systems
- Direct shield earthing and screwless connection terminals
- Space-saving width of just 8.7 mm
- Protection circuit testable with Life Control
- High bandwidth to 100 MHz
- UL-listed (4DG1)

Application: Universal use on 35 mm DIN profile rail in any standard distribution housing.

| MDP-2 D-24-T | |
|--------------------------------------|-------------------------------------|
| Maximum continuous voltage AC | U_c 20 V |
| Maximum continuous voltage DC | U_c 28 V |
| Category | Type 1+2+3 / D1+C2+C1 |
| Lightning protection zone LPZ | 0→3 |
| Number of poles | 2 |
| Rated current | I_L 0.58 A |
| Series resistance per wire | 2,35 $\Omega \pm 5\%$ |
| Impulse durability wire-wire | C1: 0,5 kV / 0,25 kA (8/20 μ s) |
| Impulse durability wire-earth | C2: 5 kV / 2,5 kA (8/20 μ s) |
| Total discharge current (8/20) | 5 kA |
| Total discharge current (10/350) | D1: 1 kA |
| Protection level wire-wire | <55 V |
| Protection level wire-earth | <800 V |
| Frequency range | 0 - 100 MHz |
| Temperature range | ϑ -40 - +80 °C |
| Installation type | DIN rail 35 mm |
| Connection system | Terminal |
| Protection rating | IP20 |
| Shielding connection available | Yes |
| Shield connection | Direct |
| Connection cross-section, flexible | 0.14 - 2.5 mm ² |
| Connection cross-section, multi-wire | 0.14 - 1.5 mm ² |
| Connection cross-section, rigid | 0.14 - 2.5 mm ² |
| Earthing via: | DIN rail |
| Testing standard | IEC 61643-21 |
| Approvals | UL |

Connection options

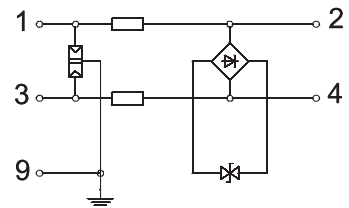



Series protection device, 3-pole, 24 V version

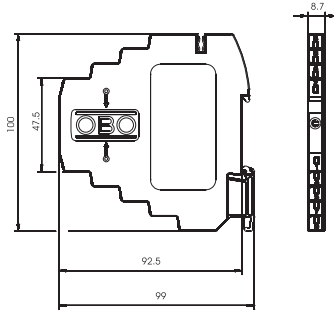

Lightning barrier with test function; 24 V version

- Rated load current 0.58 A
- Protection device for multi-wire systems
- Direct shield earthing and screwless connection terminals
- Space-saving width of just 8.7 mm
- Protection circuit testable with Life Control
- High bandwidth to 100 MHz
- UL-listed (4DG1)

Application: Universal use on 35 mm DIN profile rail in any standard distribution housing.

| Type | Max. continuous voltage AC V | Max. continuous voltage DC V | Number of poles | Connection system | Pack Piece | Weight kg/100 pc. | Item no. |
|--------------|------------------------------|------------------------------|-----------------|-------------------|------------|-------------------|----------|
| MDP-3 D-24-T | 20 | 28 | 3 | Terminal | 1 | 6.000 | 5098427 |

Connection options

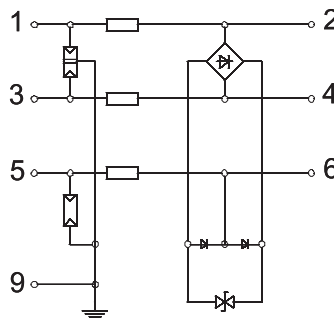

| MDP-3 D-24-T | |
|--------------------------------------|-------------------------------------|
| Maximum continuous voltage AC | U_c 20 V |
| Maximum continuous voltage DC | U_c 28 V |
| Category | Type 1+2+3 / D1+C2+C1 |
| Lightning protection zone LPZ | 0-3 |
| Number of poles | 3 |
| Rated current | I_L 0.58 A |
| Series resistance per wire | $2,35 \Omega \pm 5 \%$ |
| Impulse durability wire-wire | C1: 0,5 kV / 0,25 kA (8/20 μ s) |
| Impulse durability wire-earth | C2: 5 kV / 2,5 kA (8/20 μ s) |
| Total discharge current (8/20) | 7,5 kA |
| Total discharge current (10/350) | D1: 1,5 kA |
| Protection level wire-wire | <55 V |
| Protection level wire-earth | <800 V |
| Frequency range | 0 - 100 MHz |
| Temperature range | ϑ -40 - +80 °C |
| Installation type | DIN rail 35 mm |
| Connection system | Terminal |
| Protection rating | IP20 |
| Shielding connection available | Yes |
| Shield connection | Direct |
| Connection cross-section, flexible | 0.14 - 2.5 mm ² |
| Connection cross-section, multi-wire | 0.14 - 1.5 mm ² |
| Connection cross-section, rigid | 0.14 - 2.5 mm ² |
| Earthing via: | DIN rail |
| Testing standard | IEC 61643-21 |
| Approvals | UL |

Series protection device, 4-pole, 24 V version

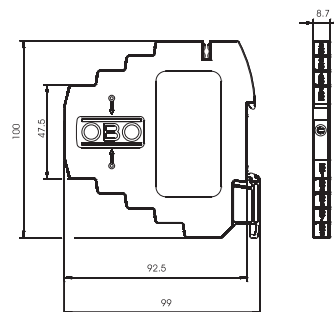

| Type | Max. continuous AC voltage V | Max. continuous DC voltage V | Number of poles | Connection system | Pack Piece | Weight kg/100 pc. | Item no. |
|--------------|------------------------------|------------------------------|-----------------|-------------------|------------|-------------------|----------|
| MDP-4 D-24-T | 20 | 28 | 4 | Terminal | 1 | 5.800 | 5098431 |

Lightning barrier with test function; 24 V version

- Rated load current 0.58 A
- Protection device for multi-wire systems
- Direct shield earthing and screwless connection terminals
- Space-saving width of just 8.7 mm
- Protection circuit testable with Life Control
- High bandwidth to 100 MHz
- UL-listed (4DG1)

Application: Universal use on 35 mm DIN profile rail in any standard distribution housing.

| MDP-4 D-24-T | |
|--------------------------------------|-------------------------------------|
| Maximum continuous voltage AC | U_c 20 V |
| Maximum continuous voltage DC | U_c 28 V |
| Category | Type 1+2+3 / D1+C2+C1 |
| Lightning protection zone LPZ | 0→3 |
| Number of poles | 4 |
| Rated current | I_L 0.58 A |
| Series resistance per wire | 2,35 Ω \pm 5 % |
| Impulse durability wire-wire | C1: 0,5 kV / 0,25 kA (8/20 μ s) |
| Impulse durability wire-earth | C2: 5 kV / 2,5 kA (8/20 μ s) |
| Total discharge current (8/20) | 10 kA |
| Total discharge current (10/350) | D1: 2 kA |
| Protection level wire-wire | <55 V |
| Protection level wire-earth | <800 V |
| Frequency range | 0 - 100 MHz |
| Temperature range | ϑ -40 - +80 °C |
| Installation type | DIN rail 35 mm |
| Connection system | Terminal |
| Protection rating | IP20 |
| Shielding connection available | Yes |
| Shield connection | Direct |
| Connection cross-section, flexible | 0.14 - 2.5 mm ² |
| Connection cross-section, multi-wire | 0.14 - 1.5 mm ² |
| Connection cross-section, rigid | 0.14 - 2.5 mm ² |
| Earthing via: | DIN rail |
| Testing standard | IEC 61643-21 |
| Approvals | UL |

Connection options

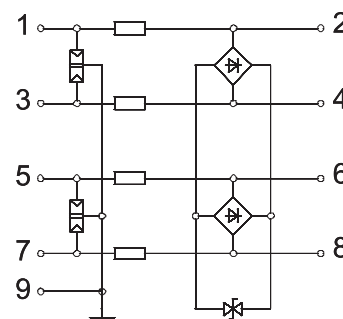



Series protection device, 2-pole, 48 V version

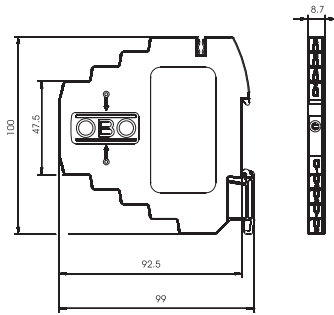

Lightning barrier with test function; 48 V version

- Rated load current 0.58 A
- Protection device for multi-wire systems
- Direct shield earthing and screwless connection terminals
- Space-saving width of just 8.7 mm
- Protection circuit testable with Life Control
- High bandwidth to 100 MHz
- UL-listed (4DG1)

Application: Universal use on 35 mm DIN profile rail in any standard distribution housing.

| Type | Max. continuous voltage AC V | Max. continuous voltage DC V | Number of poles | Connection system | Pack Piece | Weight kg/100 pc. | Item no. |
|--------------|------------------------------|------------------------------|-----------------|-------------------|------------|-------------------|----------|
| MDP-2 D-48-T | 41 | 58 | 2 | Terminal | 1 | 6.000 | 5098442 |

Connection options

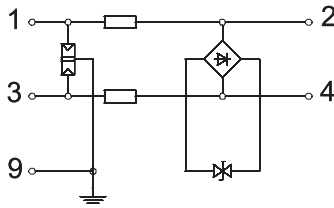

| MDP-2 D-48-T | |
|--------------------------------------|-------------------------------------|
| Maximum continuous voltage AC | U_c 41 V |
| Maximum continuous voltage DC | U_c 58 V |
| Category | Type 1+2+3 / D1+C2+C1 |
| Lightning protection zone LPZ | 0→3 |
| Number of poles | 2 |
| Rated current | I_L 0.58 A |
| Series resistance per wire | 2,35 Ω \pm 5 % |
| Impulse durability wire-wire | C1: 0,5 kV / 0,25 kA (8/20 μ s) |
| Impulse durability wire-earth | C2: 5 kV / 2,5 kA (8/20 μ s) |
| Total discharge current (8/20) | 5 kA |
| Total discharge current (10/350) | D1: 1 kA |
| Protection level wire-wire | <95 V |
| Protection level wire-earth | <800 V |
| Frequency range | 0 - 100 MHz |
| Temperature range | ϑ -40 - +80 °C |
| Installation type | DIN rail 35 mm |
| Connection system | Terminal |
| Protection rating | IP20 |
| Shielding connection available | Yes |
| Shield connection | Direct |
| Connection cross-section, flexible | 0.14 - 2.5 mm ² |
| Connection cross-section, multi-wire | 0.14 - 1.5 mm ² |
| Connection cross-section, rigid | 0.14 - 2.5 mm ² |
| Earthing via: | DIN rail |
| Testing standard | IEC 61643-21 |
| Approvals | UL |

Series protection device, 3-pole, 48 V version

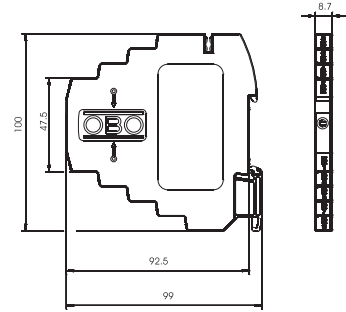

| Type | Max. continuous AC voltage V | Max. continuous DC voltage V | Number of poles | Connection system | Pack Piece | Weight kg/100 pc. | Item no. |
|--------------|------------------------------|------------------------------|-----------------|-------------------|------------|-------------------|----------|
| MDP-3 D-48-T | 41 | 58 | 3 | Terminal | 1 | 6.000 | 5098446 |

Lightning barrier with test function; 48 V version

- Rated load current 0.58 A
- Protection device for multi-wire systems
- Direct shield earthing and screwless connection terminals
- Space-saving width of just 8.7 mm
- Protection circuit testable with Life Control
- High bandwidth to 100 MHz
- UL-listed (4DG1)

Application: Universal use on 35 mm DIN profile rail in any standard distribution housing.

| MDP-3 D-48-T | |
|--------------------------------------|-------------------------------------|
| Maximum continuous voltage AC | U_c 41 V |
| Maximum continuous voltage DC | U_c 58 V |
| Category | Type 1+2+3 / D1+C2+C1 |
| Lightning protection zone LPZ | 0→3 |
| Number of poles | 3 |
| Rated current | I_L 0.58 A |
| Series resistance per wire | 2,35 Ω \pm 5 % |
| Impulse durability wire-wire | C1: 0,5 kV / 0,25 kA (8/20 μ s) |
| Impulse durability wire-earth | C2: 5 kV / 2,5 kA (8/20 μ s) |
| Total discharge current (8/20) | 7,5 kA |
| Total discharge current (10/350) | D1: 1,5 kA |
| Protection level wire-wire | <95 V |
| Protection level wire-earth | <800 V |
| Frequency range | 0 - 100 MHz |
| Temperature range | ϑ -40 - +80 °C |
| Installation type | DIN rail 35 mm |
| Connection system | Terminal |
| Protection rating | IP20 |
| Shielding connection available | Yes |
| Shield connection | Direct |
| Connection cross-section, flexible | 0.14 - 2.5 mm ² |
| Connection cross-section, multi-wire | 0.14 - 1.5 mm ² |
| Connection cross-section, rigid | 0.14 - 2.5 mm ² |
| Earthing via: | DIN rail |
| Testing standard | IEC 61643-21 |
| Approvals | UL |

Connection options

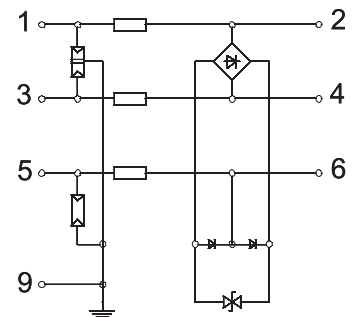



Series protection device, 4-pole, 48 V version

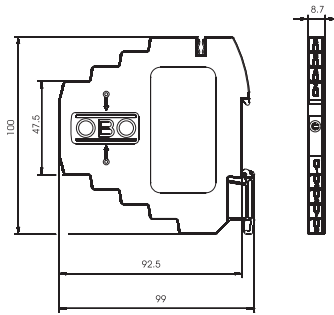

Lightning barrier with test function; 48 V version

- Rated load current 0.58 A
- Protection device for multi-wire systems
- Direct shield earthing and screwless connection terminals
- Space-saving width of just 8.7 mm
- Protection circuit testable with Life Control
- High bandwidth to 100 MHz
- UL-listed (4DG1)

Application: Universal use on 35 mm DIN profile rail in any standard distribution housing.

| Type | Max. continuous voltage AC V | Max. continuous voltage DC V | Number of poles | Connection system | Pack Piece | Weight kg/100 pc. | Item no. |
|--------------|------------------------------|------------------------------|-----------------|-------------------|------------|-------------------|----------|
| MDP-4 D-48-T | 41 | 58 | 4 | Terminal | 1 | 5.800 | 5098450 |

Connection options

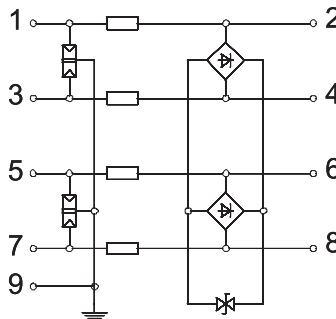

| MDP-4 D-48-T | |
|--------------------------------------|-------------------------------------|
| Maximum continuous voltage AC | U_c 41 V |
| Maximum continuous voltage DC | U_c 58 V |
| Category | Type 1+2+3 / D1+C2+C1 |
| Lightning protection zone LPZ | 0-3 |
| Number of poles | 4 |
| Rated current | I_L 0.58 A |
| Series resistance per wire | 2,35 Ω \pm 5 % |
| Impulse durability wire-wire | C1: 0,5 kV / 0,25 kA (8/20 μ s) |
| Impulse durability wire-earth | C2: 5 kV / 2,5 kA (8/20 μ s) |
| Total discharge current (8/20) | 10 kA |
| Total discharge current (10/350) | D1: 2 kA |
| Protection level wire-wire | <95 V |
| Protection level wire-earth | <800 V |
| Frequency range | 0 - 100 MHz |
| Temperature range | ϑ -40 - +80 °C |
| Installation type | DIN rail 35 mm |
| Connection system | Terminal |
| Protection rating | IP20 |
| Shielding connection available | Yes |
| Shield connection | Direct |
| Connection cross-section, flexible | 0.14 - 2.5 mm ² |
| Connection cross-section, multi-wire | 0.14 - 1.5 mm ² |
| Connection cross-section, rigid | 0.14 - 2.5 mm ² |
| Earthing via: | DIN rail |
| Testing standard | IEC 61643-21 |
| Approvals | UL |

Series protection device, 4-pole, 5 V version

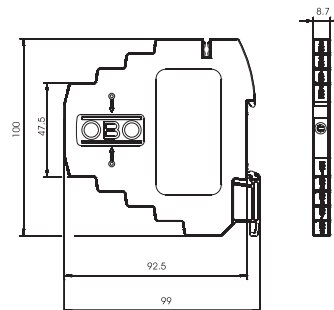

| Type | Max. continuous voltage AC V | Max. continuous voltage DC V | Number of poles | Connection system | Pack Piece | Weight kg/100 pc. | Item no. |
|-----------------------|------------------------------|------------------------------|-----------------|-------------------|------------|-------------------|----------------|
| MDP-4 D-5-T-10 | 7 | 10 | 4 | Terminal | 1 | 7.200 | 5098413 |

Lightning barrier with test function; 5 V version

- Rated load current 10 A
- Protection device for multi-wire systems
- Direct shield earthing and screwless connection terminals
- Space-saving width of just 8.7 mm
- Protection circuit testable with Life Control
- High bandwidth to 100 MHz
- UL-listed (4DG1)

Application: Universal use on 35 mm DIN rail in any standard distribution housing.

| MDP-4 D-5-T-10 | |
|--------------------------------------|-------------------------------------|
| Maximum continuous voltage AC | U_c 7 V |
| Maximum continuous voltage DC | U_c 10 V |
| Category | Type 1+2+3 / D1+C2+C1 |
| Lightning protection zone LPZ | 0→3 |
| Number of poles | 4 |
| Rated current | I_L 10 A |
| Series resistance per wire | — |
| Impulse durability wire-wire | C1: 0,5 kV / 0,25 kA (8/20 μ s) |
| Total discharge current (8/20) | 10 kA |
| Total discharge current (10/350) | D1: 2 kA |
| Protection level wire-wire | <45 V |
| Protection level wire-earth | <800 V |
| Frequency range | 0 - 100 MHz |
| Temperature range | ϑ -40 - +80 °C |
| Installation type | DIN rail |
| Connection system | Terminal |
| Protection rating | IP20 |
| Shielding connection available | Yes |
| Shield connection | Direct |
| Connection cross-section, flexible | 0.14 - 2.5 mm ² |
| Connection cross-section, multi-wire | 0.14 - 1.5 mm ² |
| Connection cross-section, rigid | 0.14 - 2.5 mm ² |
| Earthing via: | DIN rail |
| Testing standard | IEC 61643-21 |
| Approvals | UL |

Connection options

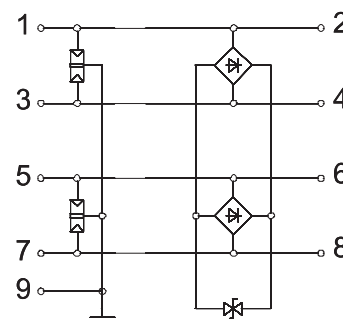



Series protection device, 2-pole, 12 V version

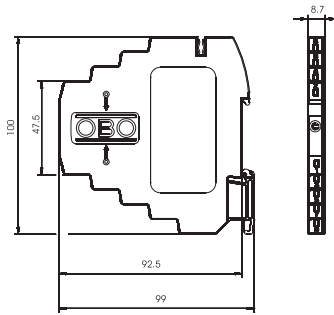

Lightning barrier with test function; 12 V version

- Rated load current 10 A
- Protection device for multi-wire systems
- Direct shield earthing and screwless connection terminals
- Space-saving width of just 8.7 mm
- Protection circuit testable with Life Control
- High bandwidth to 100 MHz
- UL-listed (4DG1)

Application: Universal use on 35 mm DIN profile rail in any standard distribution housing.

| Type | Max. continuous AC voltage V | Max. continuous DC voltage V | Number of poles | Connection system | Pack Piece | Weight kg/100 pc. | Item no. |
|-----------------|------------------------------|------------------------------|-----------------|-------------------|------------|-------------------|----------|
| MDP-2 D-12-T-10 | 10.5 | 15 | 2 | Terminal | 1 | 6.000 | 5098415 |

Connection options

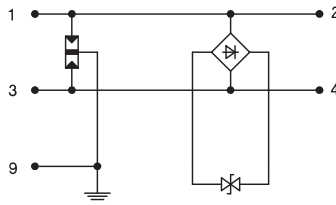

| MDP-2 D-12-T-10 | |
|--------------------------------------|-------------------------------------|
| Maximum continuous voltage AC | U_c 10.5 V |
| Maximum continuous voltage DC | U_c 15 V |
| Category | Type 1+2+3 / D1+C2+C1 |
| Lightning protection zone LPZ | 0→3 |
| Number of poles | 2 |
| Rated current | I_L 10 A |
| Series resistance per wire | — |
| Impulse durability wire-wire | C1: 0,5 kV / 0,25 kA (8/20 μ s) |
| Total discharge current (8/20) | 5 kA |
| Total discharge current (10/350) | D1: 1 kA |
| Protection level wire-wire | <55 V |
| Protection level wire-earth | <800 V |
| Frequency range | 0 - 100 MHz |
| Temperature range | ϑ -40 - +80 °C |
| Installation type | DIN rail |
| Connection system | Terminal |
| Protection rating | IP20 |
| Shielding connection available | Yes |
| Shield connection | Direct |
| Connection cross-section, flexible | 0.14 - 2.5 mm ² |
| Connection cross-section, multi-wire | 0.14 - 1.5 mm ² |
| Connection cross-section, rigid | 0.14 - 2.5 mm ² |
| Earthing via: | DIN rail |
| Testing standard | IEC 61643-21 |
| Approvals | UL |

Series protection device, 4-pole, 12 V version

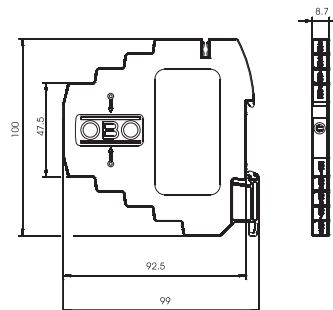

| Type | Max. continuous voltage AC V | Max. continuous voltage DC V | Number of poles | Connection system | Pack Piece | Weight kg/100 pc. | Item no. |
|------------------------|------------------------------|------------------------------|-----------------|-------------------|------------|-------------------|----------------|
| MDP-4 D-12-T-10 | 10.5 | 15 | 4 | Terminal | 1 | 6.000 | 5098419 |

Lightning barrier with test function; 12 V version

- Rated load current 10 A
- Protection device for multi-wire systems
- Direct shield earthing and screwless connection terminals
- Space-saving width of just 8.7 mm
- Protection circuit testable with Life Control
- High bandwidth to 100 MHz
- UL-listed (4DG1)

Application: Universal use on 35 mm DIN profile rail in any standard distribution housing.

| MDP-4 D-12-T-10 | |
|--------------------------------------|-------------------------------------|
| Maximum continuous voltage AC | U_c 10.5 V |
| Maximum continuous voltage DC | U_c 15 V |
| Category | Type 1+2+3 / D1+C2+C1 |
| Lightning protection zone LPZ | 0→3 |
| Number of poles | 4 |
| Rated current | I_L 10 A |
| Series resistance per wire | — |
| Impulse durability wire-wire | C1: 0,5 kV / 0,25 kA (8/20 μ s) |
| Total discharge current (8/20) | 10 kA |
| Total discharge current (10/350) | D1: 2 kA |
| Protection level wire-wire | <55 V |
| Protection level wire-earth | <800 V |
| Frequency range | 0 - 100 MHz |
| Temperature range | ϑ -40 - +80 °C |
| Installation type | DIN rail |
| Connection system | Terminal |
| Protection rating | IP20 |
| Shielding connection available | Yes |
| Shield connection | Direct |
| Connection cross-section, flexible | 0.14 - 2.5 mm ² |
| Connection cross-section, multi-wire | 0.14 - 1.5 mm ² |
| Connection cross-section, rigid | 0.14 - 2.5 mm ² |
| Earthing via: | DIN rail |
| Testing standard | IEC 61643-21 |
| Approvals | UL |

Connection options

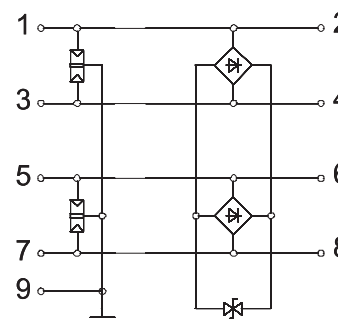



Series protection device, 2-pole, 24 V version

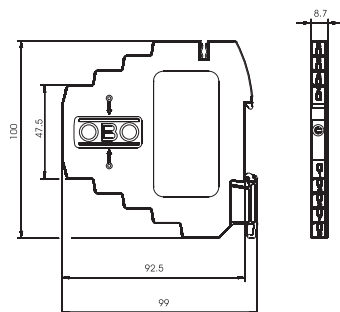

Lightning barrier with test function; 24 V version

- Rated load current 10 A
- Protection device for multi-wire systems
- Direct shield earthing and screwless connection terminals
- Space-saving width of just 8.7 mm
- Protection circuit testable with Life Control
- High bandwidth to 100 MHz
- UL-listed (4DG1)

Application: Universal use on 35 mm DIN profile rail in any standard distribution housing.

| Type | Max. continuous AC voltage V | Max. continuous DC voltage V | Number of poles | Connection system | Pack Piece | Weight kg/100 pc. | Item no. |
|-----------------|------------------------------|------------------------------|-----------------|-------------------|------------|-------------------|----------|
| MDP-2 D-24-T-10 | 20 | 28 | 2 | Terminal | 1 | 6.000 | 5098425 |

Connection options

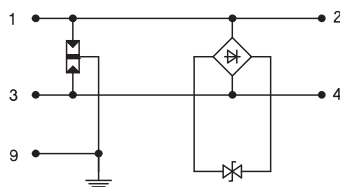

| MDP-2 D-24-T-10 | |
|--------------------------------------|-------------------------------|
| Maximum continuous voltage AC | U_c 20 V |
| Maximum continuous voltage DC | U_c 28 V |
| Category | Type 1+2+3 / D1+C2+C1 |
| Lightning protection zone LPZ | 0→3 |
| Number of poles | 2 |
| Rated current | I_L 10 A |
| Series resistance per wire | — |
| Impulse durability wire-wire | C1: 0,5 kV / 0,25 kA (8/20μs) |
| Total discharge current (8/20) | 5 kA |
| Total discharge current (10/350) | D1: 1 kA |
| Protection level wire-wire | <70 V |
| Protection level wire-earth | <800 V |
| Frequency range | 0 - 100 MHz |
| Temperature range | θ -40 - +80 °C |
| Installation type | DIN rail |
| Connection system | Terminal |
| Protection rating | IP20 |
| Shielding connection available | Yes |
| Shield connection | Direct |
| Connection cross-section, flexible | 0.14 - 2.5 mm ² |
| Connection cross-section, multi-wire | 0.14 - 1.5 mm ² |
| Connection cross-section, rigid | 0.14 - 2.5 mm ² |
| Earthing via: | DIN rail |
| Testing standard | IEC 61643-21 |
| Approvals | UL |

Connectable data cable protection, 2-pole, direct earthing

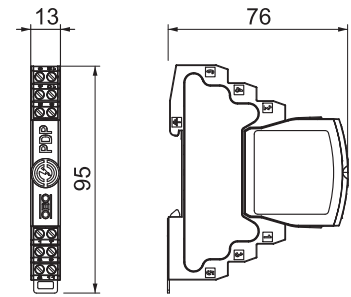

| Type | Max. continuous voltage AC V | Max. continuous voltage DC V | Number of poles | Pack Piece | Weight kg/100 pc. | Item no. |
|-------------------|------------------------------|------------------------------|-----------------|------------|-------------------|----------------|
| PDP-2-5-D | 4.2 | 6 | 2 | 1 | 6.500 | 5080301 |
| PDP-2-12-D | 12 | 16 | 2 | 1 | 6.500 | 5080303 |
| PDP-2-24-D | 21 | 30 | 2 | 1 | 6.500 | 5080305 |
| PDP-2-48-D | 37 | 52 | 2 | 1 | 6.500 | 5080307 |

Connectable data cable protection, type 1+2/D1+C2 for use in measurement and control technology

- Protection device for multi-wire systems
- Direct shield earthing
- Frequency range up to 100 MHz
- Earthing via DIN rail or connection cable
- Installation width from 12.5 mm
- High system availability – no signal interruption without protection module

Application: Universal lightning and surge protection for MCR data transmission devices.



Connectable data cable protection, 2-pole, indirect earthing

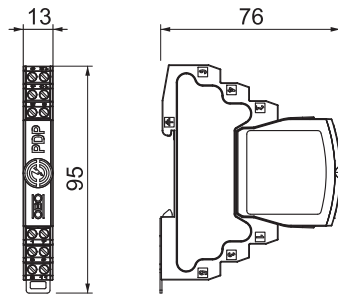

Connectable data cable protection, type 1+2/D1+C2 for use in measurement and control technology

- Protection device for multi-wire systems
- Indirect shield earthing
- Frequency range up to 100 MHz
- Earthing via DIN rail or connection cable
- Small installation width of 12.5 mm
- High system availability - no signal interruption without protection module

Application: Universal lightning and surge protection for MCR data transmission devices.

| Type | Max. continuous voltage AC V | Max. continuous voltage DC V | Number of poles | Pack Piece | Weight kg/100 pc. | Item no. |
|-------------------|------------------------------|------------------------------|-----------------|------------|-------------------|----------------|
| PDP-2-5-I | 4.2 | 6 | 2 | 1 | 6.600 | 5080309 |
| PDP-2-12-I | 12 | 16 | 2 | 1 | 6.600 | 5080311 |
| PDP-2-24-I | 21 | 30 | 2 | 1 | 6.600 | 5080313 |
| PDP-2-48-I | 37 | 52 | 2 | 1 | 6.600 | 5080315 |

Tele Defender

Combined protection device for VDSL, ISDN and DSL systems



- Low protection level at a high current load
- "Push-in" clamps for quick installation
- Bandwidth-optimised for secure transmission up to 225 MHz
- Surface mounting

The data cable protection devices for telecommunications applications are available as combination protection and fine protection. Depending on the application, from DSL through to analogue communication, the devices are used for direct intermediate switching into the data cable, meaning that

they can easily be retrofitted in existing installations. The devices differ in their connection technology and transmission cable and are thus optimised for their appropriate applications, in order to cause the lowest attenuation level possible.



Combination protection device TD-4/I for ISDN and DSL systems

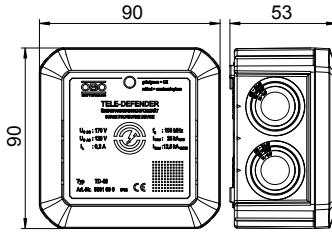

Data cable protection device for telecommunications equipment

- Low protection level at a high current load
 - "Push-in" terminals for quick installation
 - Bandwidth-optimised for secure transmission
 - Surface mounting
 - Visual function display
- Application: DSL systems, IP connections, ISDN or analogue telecommunications

| Type | Max. continuous voltage AC V | Max. continuous voltage DC V | Number of poles | Connection system | Pack Piece | Weight kg/100 pc. | Item no. |
|---------------|------------------------------|------------------------------|-----------------|-------------------|------------|-------------------|----------------|
| TD-4/I | 120 | 170 | 4 | Terminal | 1 | 11.000 | 5081690 |

Connection options

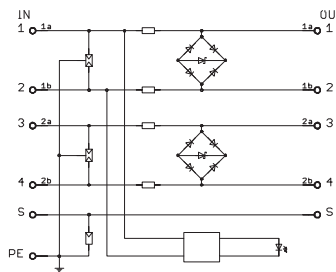

| TD-4/I | |
|---------------------------------------|-----------------------------|
| Maximum continuous voltage AC | U_c 120 V |
| Maximum continuous voltage DC | U_c 170 V |
| Category | Type 1+2+3 / D1+C2+C1 |
| Lightning protection zone LPZ | 0→3 |
| Number of poles | 4 |
| Rated current | I_L 0.2 A |
| Capacity (wire-wire) | <50 pF |
| Capacity (wire-earth) | <10 pF |
| Series resistance per wire | 9 Ω ± 10 % |
| Impulse durability wire-wire | C2: 18 kV / 9 kA (8/20μs) |
| Impulse durability wire-earth | C2: 18 kV / 9 kA (8/20μs) |
| Impulse discharge current (10/350) | I_{imp} 2.5 kA |
| Total discharge current (8/20) | 25 kA |
| Total discharge current (10/350) | D1: 12,5 kA |
| Protection level wire-wire | <300 V |
| Protection level wire-earth | <650 V |
| Protection level, shield-earth (S-PE) | 850 V |
| Frequency range | 0 - 100 MHz |
| Insertion loss | S_{21} ≤3 dB |
| Temperature range | ϑ -40 - +80 °C |
| Installation type | Surface-mounted |
| Connection system | Terminal |
| Protection rating | IP54 |
| Shielding connection available | Yes |
| Connection cross-section, flexible | 0.14 - 0.75 mm ² |
| Connection cross-section, multi-wire | 0.14 - 0.75 mm ² |
| Connection cross-section, rigid | 0.14 - 0.75 mm ² |
| Testing standard | IEC 61643-21 |

Schutzinstallationen Überspannungsschutz und Explosionsschutz / en / 2021/06/25 09:52:32 (LLExpert_02926) / 2021/06/25

Surge protection

Combination protection device TD-2d-V for VDSL systems

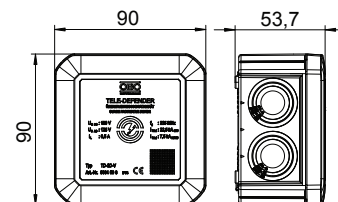

Surge protection

| Type | Max. continuous voltage AC V | Max. continuous voltage DC V | Number of poles | Connection system | Pack Piece | Weight kg/100 pc. | Item no. |
|----------------|------------------------------|------------------------------|-----------------|-------------------|------------|-------------------|----------------|
| TD-2D-V | 125 | 180 | 2 | Terminal | 1 | 9.500 | 5081698 |

Data cable protection device for telecommunications equipment

- Low protection level at a high current load
- "Push-in" clamps for quick installation
- Bandwidth-optimised for secure transmission up to 225 MHz
- Surface mounting

Application: Ideal for all DSL systems, IP connections, ISDN or analogue telecommunications

| TD-2D-V | |
|--------------------------------------|-----------------------------------|
| Maximum continuous voltage AC | U_c 125 V |
| Maximum continuous voltage DC | U_c 180 V |
| Category | Type 1+2+3 / D1+C2+C1 |
| Lightning protection zone LPZ | 0-3 |
| Number of poles | 2 |
| Rated current | I_L 0.5 A |
| Capacity (wire-wire) | <10 pF |
| Capacity (wire-earth) | <20 pF |
| Series resistance per wire | 2,2 Ω \pm 5 % |
| Impulse durability wire-wire | C2: 15 kV / 7,5 kA (8/20 μ s) |
| Impulse durability wire-earth | C2: 15 kV / 7,5 kA (8/20 μ s) |
| Impulse discharge current (10/350) | I_{imp} 2.5 kA |
| Total discharge current (8/20) | 22,5 kA |
| Total discharge current (10/350) | D1: 7,5 kA |
| Protection level wire-wire | <350 V |
| Protection level wire-earth | <600 V |
| Frequency range | 0 - 225 MHz |
| Insertion loss | S_{21} \leq 3 dB |
| Temperature range | ϑ -40 - +80 °C |
| Installation type | Surface-mounted |
| Connection system | Terminal |
| Protection rating | IP54 |
| Shielding connection available | Yes |
| Connection cross-section, flexible | 0.14 - 1 mm ² |
| Connection cross-section, multi-wire | 0.14 - 1 mm ² |
| Connection cross-section, rigid | 0.08 - 1.5 mm ² |
| Testing standard | IEC 61643-21 |

Connection options

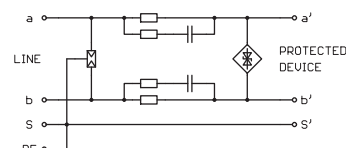



Combination protection device TD-2/D-HS for ISDN and DSL systems

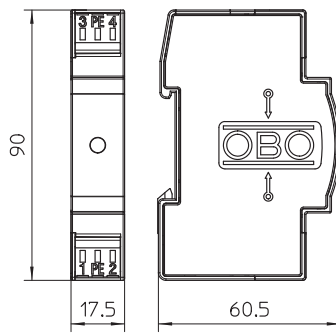

Data cable protection devices for telecommunication systems

- Low protection level at high current load
- Screwless terminals or connectable
- Bandwidth-optimised for secure transmission
- Quick mounting onto DIN rail for a telephone line
- Visual function display

Application: DSL systems, ISDN or analogue telecommunication

| Type | Max. continuous voltage AC V | Max. continuous voltage DC V | Number of poles | Connection system | Pack Piece | Weight kg/100 pc. | Item no. |
|------------------|------------------------------|------------------------------|-----------------|-------------------|------------|-------------------|----------------|
| TD-2/D-HS | 120 | 170 | 2 | Terminal | 1 | 4.800 | 5081694 |

Connection options

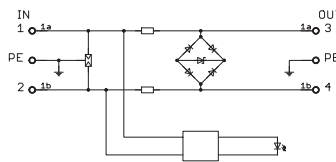

| TD-2/D-HS | |
|--------------------------------------|----------------------------|
| Maximum continuous voltage AC | U_c 120 V |
| Maximum continuous voltage DC | U_c 170 V |
| Category | Type 1+2+3 / D1+C2+C1 |
| Lightning protection zone LPZ | 0→3 |
| Number of poles | 2 |
| Rated current | I_L 0.2 A |
| Capacity (wire-wire) | <50 pF |
| Capacity (wire-earth) | <50 pF |
| Series resistance per wire | 9 Ω ± 10 % |
| Impulse durability wire-wire | C2: 18 kV / 9 kA (8/20μs) |
| Impulse durability wire-earth | C2: 18 kV / 9 kA (8/20μs) |
| Impulse discharge current (10/350) | I_{imp} 2.5 kA |
| Total discharge current (8/20) | 10 kA |
| Total discharge current (10/350) | D1: 5 kA kA |
| Protection level wire-wire | <300 V |
| Protection level wire-earth | <650 V |
| Frequency range | 0 - 75 MHz |
| Insertion loss | S_{21} ≤3 dB |
| Temperature range | ϑ -40 - +80 °C |
| Installation type | DIN rail 35 mm |
| Connection system | Terminal |
| Protection rating | IP20 |
| Shielding connection available | No |
| Connection cross-section, flexible | 0.14 - 2.5 mm ² |
| Connection cross-section, multi-wire | 0.14 - 2.5 mm ² |
| Connection cross-section, rigid | 0.14 - 2.5 mm ² |
| Testing standard | IEC 61643-21 |



Tele Defender

Combination and fine protection devices RJ11-Tele and RJ45 Tele for analogue cables



- In aluminium housing
- With two-stage protection circuit
- Simple mounting
- Inc. 150 mm connecting cable with RJ 11 and/or RJ 45 connectors
- Optimised bandwidth for TC systems
- DIN rail mounting

The data cable protection devices for telecommunications applications are available as combination protection and fine protection. Depending on the application, from DSL through to analogue communication, the devices are used for direct intermediate switching into the data cable, meaning that

they can easily be retrofitted in existing installations. The devices differ in their connection technology and transmission cable and are thus optimised for their appropriate applications, in order to cause the lowest attenuation level possible.



Fine protection device TELE 4-F for ISDN RJ11

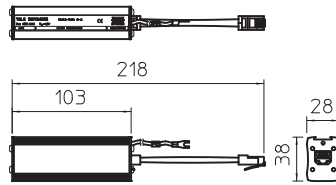

Data line protection device for analogue telecommunications systems

- In aluminium housing
- With 2-stage protection circuit
- Simple mounting
- Incl. 150 mm connection cable with RJ11 and/or RJ45 connectors
- Optimised bandwidth for TC systems
- DIN rail mounting with DLS-BS accessories (5082 38 2)

Application: For analogue telecommunication systems

| Type | Version | Connection system | Pack Piece | Weight kg/100 pc. | Item no. |
|----------------------|--------------------------|-------------------|------------|-------------------|----------------|
| RJ11-TELE 4-F | Fine protection, 4 wires | RJ11 | 1 | 14.000 | 5081977 |

Connection options

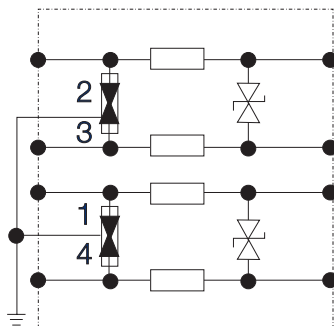

| RJ11-TELE 4-F | |
|--|--------------------------|
| Maximum continuous voltage AC | U_c 120 V |
| Maximum continuous voltage DC | U_c 170 V |
| Category | Type 2+3 / C2+C1 |
| Lightning protection zone LPZ | 1-3 |
| Number of poles | 4 |
| Series resistance per wire | $2,2 \Omega \pm 10 \%$ |
| Total discharge current (8/20) | 4 kA |
| Protection level wire-wire | <300 V |
| Protection level wire-earth | <600 V |
| Protection level, wire-earth at 1 kV/ μ s (C3) | U_p <245 V |
| Frequency range | 0 - 18 MHz |
| Insertion loss | S_{21} ≤ 3 dB |
| Temperature range | ϑ -40 - +80 °C |
| Installation type | Connector/cable adapter |
| Connection system | RJ11 |
| Protection rating | IP40 |
| Earthing via: | Connection cable |
| Testing standard | IEC 61643-21 |



Combination protection device TELE 4-C for ISDN RJ11

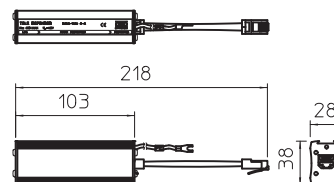

| Type | Version | Connection system | Pack Piece | Weight kg/100 pc. | Item no. |
|----------------------|---------------------------|-------------------|------------|-------------------|----------------|
| RJ11-TELE 4-C | Combi protection, 4 wires | RJ11 | 1 | 14.000 | 5081975 |

Data line protection device for analogue telecommunications systems

- In aluminium housing
- With 2-stage protection circuit
- Simple mounting
- Incl. 150 mm connection cable with RJ11 and/or RJ45 connectors
- Optimised bandwidth for TC systems
- DIN rail mounting with DLS-BS accessories (5082 38 2)

Application: For analogue telecommunication systems

| RJ11-TELE 4-C | |
|--|--------------------------|
| Maximum continuous voltage AC | U_c 120 V |
| Maximum continuous voltage DC | U_c 170 V |
| Category | Type 1+2+3 / D1+C2+C1 |
| Lightning protection zone LPZ | 0-3 |
| Number of poles | 4 |
| Series resistance per wire | $8,2 \Omega \pm 10 \%$ |
| Total discharge current (8/20) | 4 kA |
| Total discharge current (10/350) | 1,5 kA |
| Protection level wire-wire | <300 V |
| Protection level wire-earth | <600 V |
| Protection level, wire-earth at 1 kV/ μ s (C3) | U_p <245 V |
| Frequency range | 0 - 12 MHz |
| Insertion loss | S_{21} ≤ 3 dB |
| Temperature range | ϑ -40 - +80 °C |
| Installation type | Connector/cable adapter |
| Connection system | RJ11 |
| Protection rating | IP40 |
| Earthing via: | Connection cable |
| Testing standard | IEC 61643-21 |

Connection options

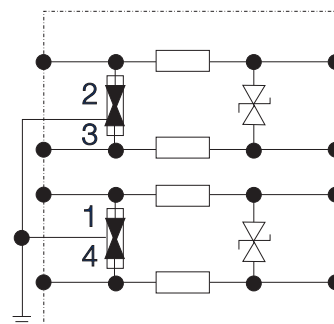

LSA-Plus technology

Basic and fine protection

Surge protective devices for industrial telecommunications applications

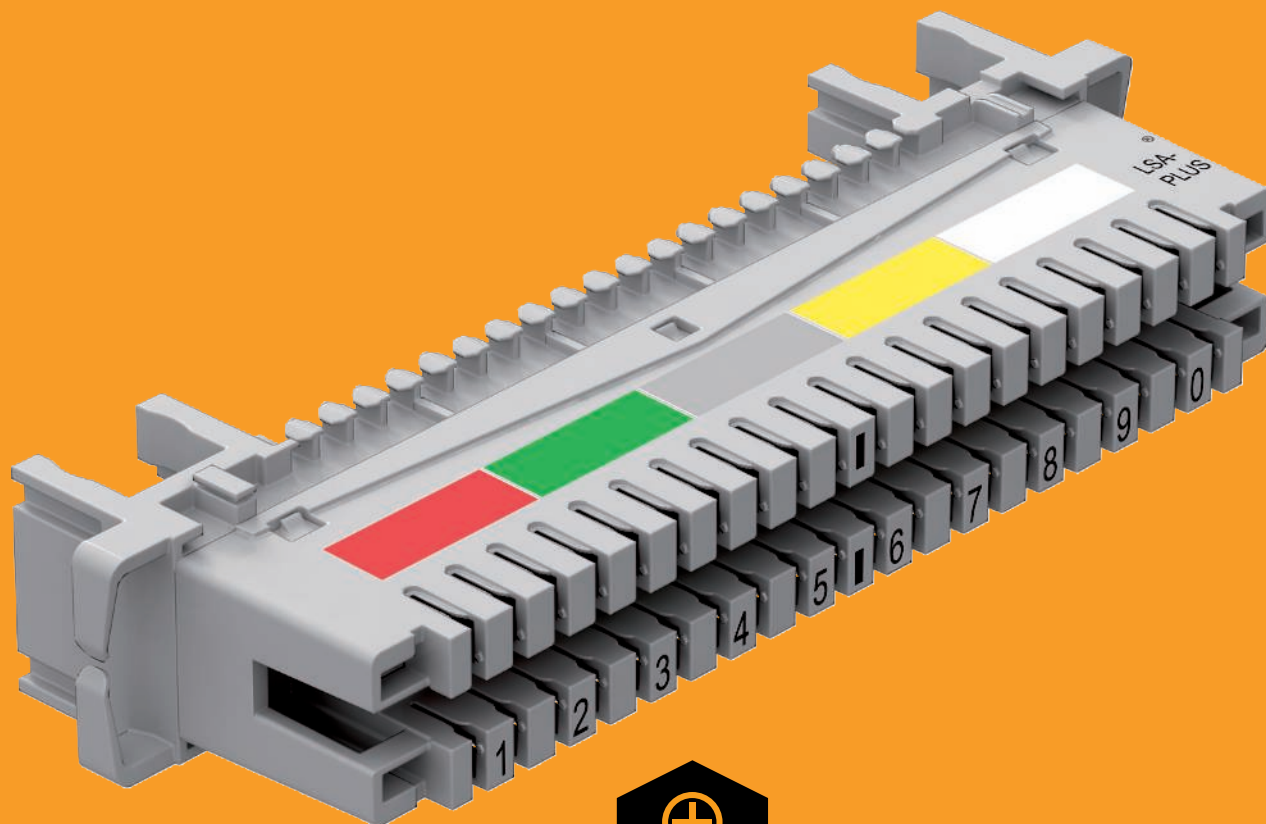

- Simple installation
- Protection up to ten two-core wires
- Low protection level
- High arresting capacity
- High broadband in basic protection
- Wide range of uses

In particular with multi-wire cable systems, such as telecommunications distribution systems, the LSA surge voltage components offer rapid, adequate protection. The LSA system offers both basic protection modules and fine protection modules to

protect up to ten two-core wires per connection strip. These are split up into separating and connection strips and must be selected according to the application.



LSA basic protection magazine

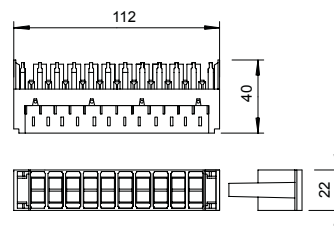
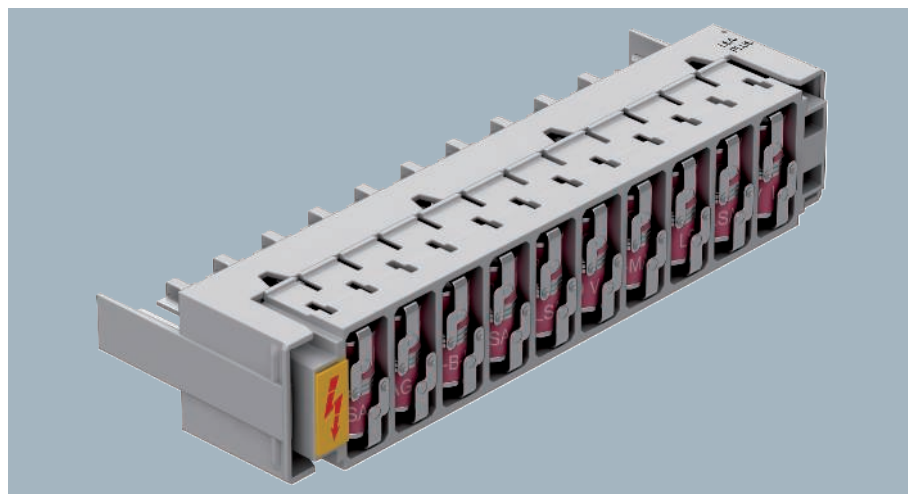

| Type | Installation type | Number of poles | Pack Piece | Weight kg/100 pc. | Item no. |
|-----------|-----------------------|-----------------|------------|-------------------|----------|
| LSA-B-MAG | LSA-Plus, connectable | 20 | 1 | 8.600 | 5084020 |

LSA basic protection magazine for use in multi-core data cable systems, MCR systems and telephone switchboards.

- Basic protection
- Equipped with 20 gas arresters
- Max. voltage: 180 V

Application: Directly on LSA-Plus separating strips or connection rails (e.g. OBO LSA-A-LEI (5084 00 8) or OBO LSA-T-LEI (5084 01 2)).

Combination protection device LSA BF 180

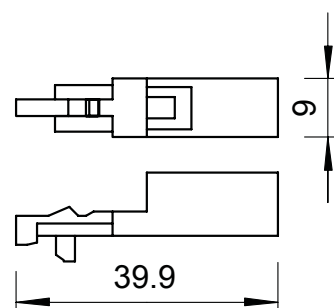
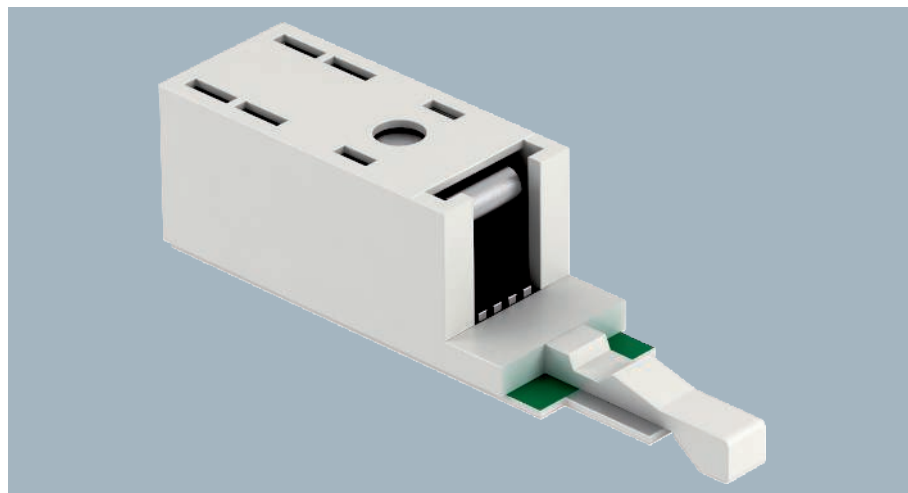

| Type | Installation type | Number of poles | Pack Piece | Weight kg/100 pc. | Item no. |
|------------|-----------------------|-----------------|------------|-------------------|----------|
| LSA-BF-180 | LSA-Plus, connectable | 2 | 1 | 0.500 | 5084024 |

LSA basic and fine protection, for application in MCR systems

- Basic and fine protection
- Coarse protection using fail-safe technology.
- With PTC protection components against overcurrent.
- Max. voltage: 180 V

Application: Directly on LSA-Plus separating strip or connection rails with earthing rail (e.g. OBO LSA-A-LEI (5084 00 8) or OBO LSA-T-LEI (5084 01 2), and OBO LSA-E (5084 03 2))



LSA connection strip

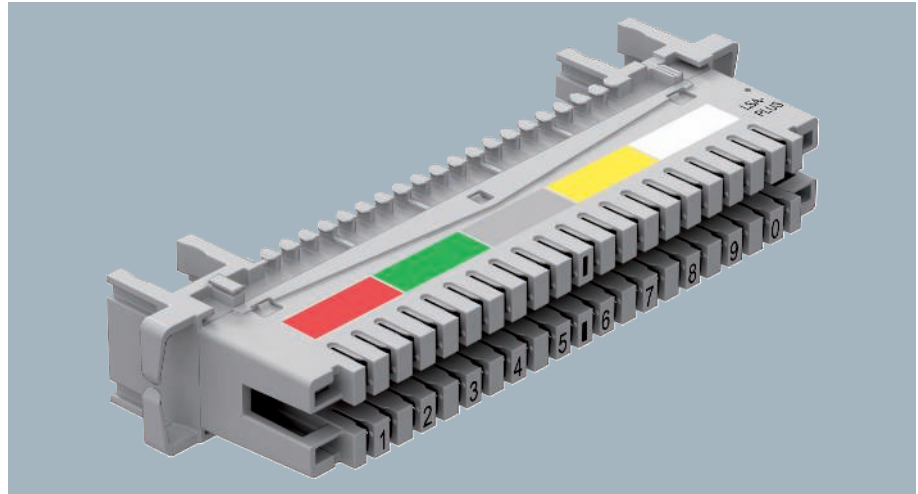
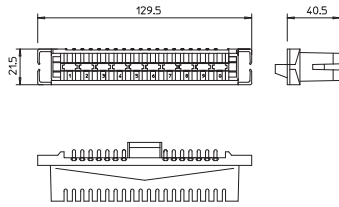

LSA connection strip 2/10 for attaching 10 double-cores.

- For use with protection element LSA-B-MAG
- Fastening to mounting trough LSA-M
- Colour: Grey
- Clampable cross-sections 0.14–0.5 (AWG 26-20)

| Type | Colour | Pack Piece | Weight kg/100 pc. | Item no. |
|-----------|--------|------------|-------------------|----------|
| LSA-A-LEI | Grey | 1 | 5.100 | 5084008 |



LSA separating strip

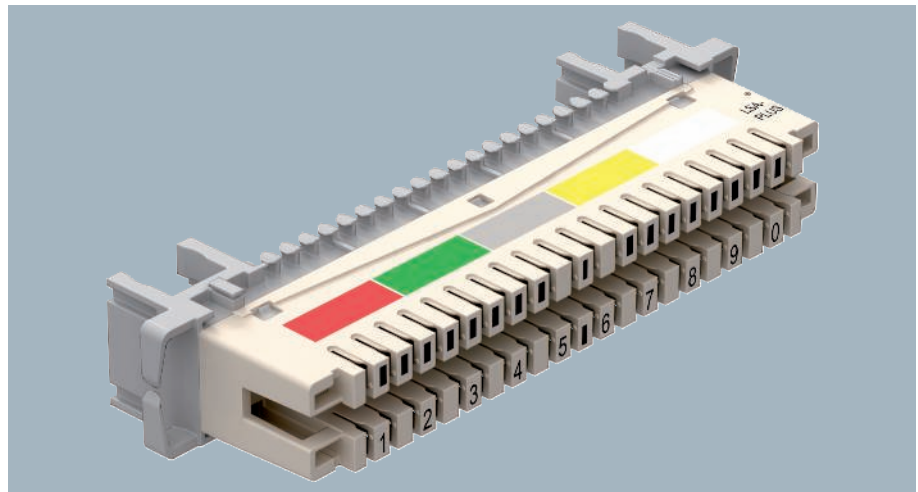
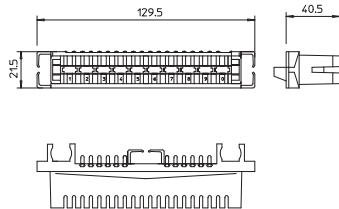

LSA separating strip 2/10 for attaching up to 10 double-cores.

- For use with protection element LSA-BF-180; LSA-BF-24; LSA-B-MAG
- Fastening to mounting trough LSA-M
- Colour: White
- Clampable cross-sections 0.14–0.5 mm2 (AWG 26-20)

| Type | Colour | Pack Piece | Weight kg/100 pc. | Item no. |
|-----------|--------|------------|-------------------|----------|
| LSA-T-LEI | White | 1 | 5.400 | 5084012 |



LSA earthing strip

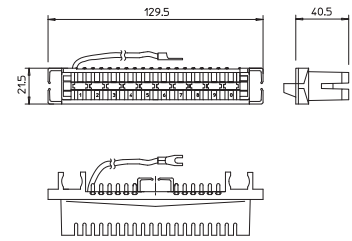
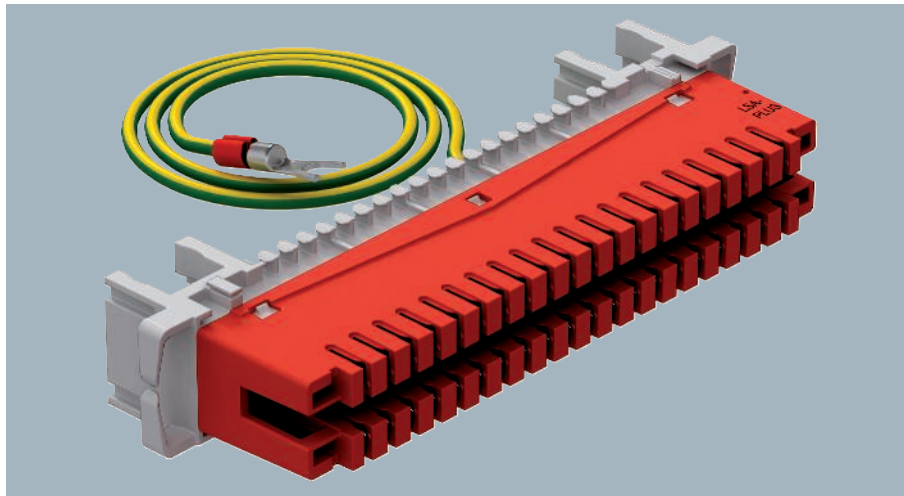

| Type | Colour | Pack Piece | Weight kg/100 pc. | Item no. |
|-----------|--------|------------|-------------------|----------|
| LSA-E-LEI | Red | 1 | 6.500 | 5084016 |

LSA earthing strip, 40-pole for connecting earthing cables or screens to the earth connection.

- Complete with connection line, green-yellow, 1.5 mm²
- Colour: Red

LSA simple tool

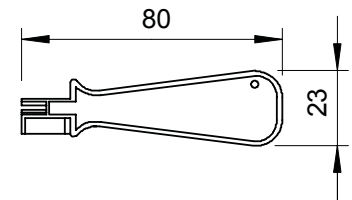

| Type | Pack Piece | Weight kg/100 pc. | Item no. |
|----------|------------|-------------------|----------|
| LSA-TOOL | 1 | 0.600 | 5084040 |

Simple tool for the soldering, bolting and stripping-free connection of cores, without cutter.





LSA earthing rail

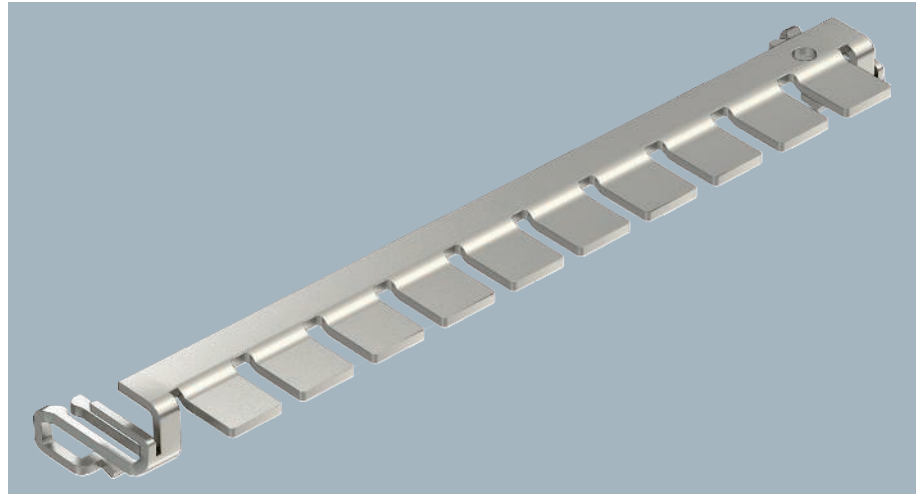
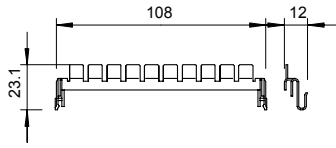

Earth rail as earth connection between surge protectors LFS-BF... (1 DA) and distributor connector LSA-...-LEI.

| Type | Pack Piece | Weight kg/100 pc. | Item no. |
|-------|------------|-------------------|----------|
| LSA-E | 1 | 1.275 | 5084032 |

St



LSA installation trough

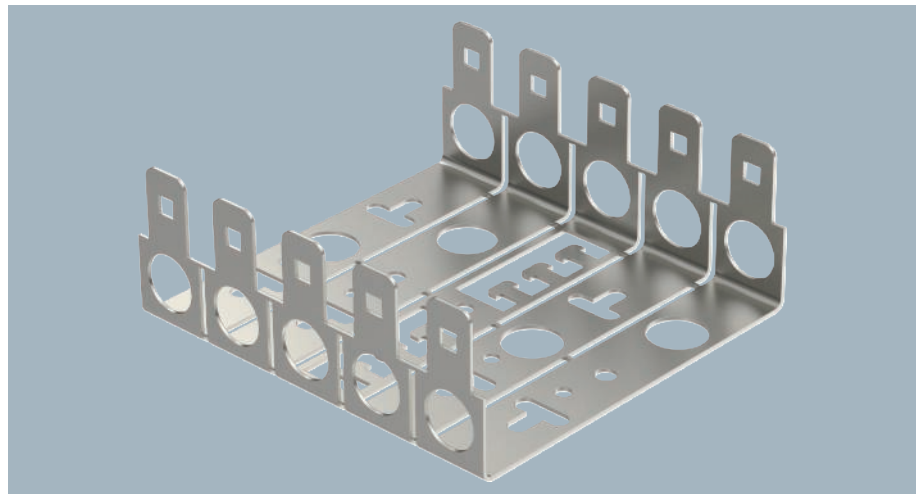
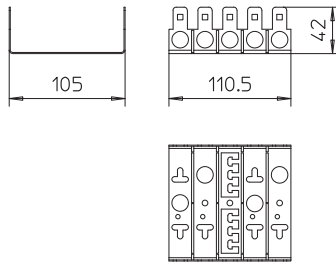

Installation trough for 5 connection rails or separating strips. Grid 22.5 mm.
Depth: 22 mm; 30 mm; 50 mm

| Type | Pack Piece | Weight kg/100 pc. | Item no. |
|-------|------------|-------------------|----------|
| LSA-M | 1 | 7.800 | 5084036 |



LSA protective housing

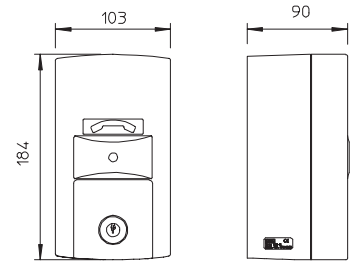

| Type | Colour | Pack Piece | Weight kg/100 pc. | Item no. |
|-------|------------|------------|-------------------|----------|
| LSA-G | Light grey | 1 | 57.500 | 5084048 |

Protective housing for an LSA 10 DA bar

- Protective housing for 10 wire pairs
- Housing can be locked
- Incl. key
- 4x cable fixing
- Light grey

Net Defender

Surge protection for data and network technology
PoE++ or 4PPoE Standard (IEEE 802.3bt)



- Connectable protection device
- High-performance surge protection
- Usable in the "Channel Link" up to 10 GBit
- Supports Power over Ethernet to 1 A
- Testing protocol available

The "Net Defender" permits the use of Power over Ethernet with nominal currents of up to 1 A and optimised surge protection in the channel up to 10 GBit/s. This corresponds to a Channel Performance according to ISO/IEC 11801 Amd. 2 of Class EA or CAT 6A to TIA/ANSI. Of course,

reverse compatibility is also guaranteed. To ensure easy installation, the "Net Defender" can be snapped directly onto the DIN rail and uses it to create the necessary equipotential bonding. Alternatively, terminal protection using a separately connectable earthing line is possible.



Surge protection for high-speed networks up to 10 GBit (Class EA/CAT6A)

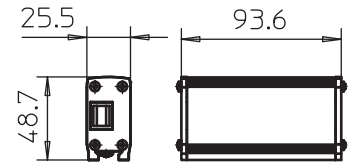

| Type | Version | Connection system | Pack Piece | Weight kg/100 pc. | Item no. |
|-------------|-----------------------------------|-------------------|------------|-------------------|----------|
| ND-CAT6A/EA | Fine protection, 8 wires + shield | RJ45 8(8) | 1 | 16.600 | 5081800 |

- Data cable protection device for high-speed networks
- Protection class: Fine protection
 - High-quality RJ45 sockets
 - Low protection level at high current load
 - Earthing via DIN rail or connection cable
 - Support of Power over Ethernet ++ (PoE++/4PPoE) to 1 A in accordance with IEEE 802.3
 - Tested transmission quality in networks up to 10 GBit/s (Class EA) or CAT6
 - Rapid installation through plug-in version
 - Incl. DIN rail fastening set and earthing cable

Application example: 10 GBit Ethernet, 10/100 MBit Ethernet, PoE applications, IP camera systems, ISDN S0 interfaces

| ND-CAT6A/EA | |
|-------------------------------------|-------------------------------------|
| Maximum continuous voltage AC U_c | 41 V |
| Maximum continuous voltage DC U_c | 58 V |
| Category | Type 2+3 / C2+C1 |
| Lightning protection zone LPZ | 1-3 |
| Channel performance ISO/IEC | Class EA |
| Channel performance Ansi/EA | CAT 6A |
| Number of poles | 8 |
| Rated current I_L | 1 A |
| Impulse durability wire-wire | C1: 0,3 kV / 0,15 kA (8/20 μ s) |
| Impulse durability wire-earth | C2: 2 kV / 1 kA (8/20 μ s) |
| Total discharge current (8/20) | 7 kA |
| Protection level wire-wire | <120 V |
| Protection level wire-earth | <700 V |
| Frequency range | >500 MHz |
| Temperature range ϑ | -40 - +80 °C |
| Installation type | Connector/cable adapter |
| Connection system | RJ45 8(8) |
| Protection rating | IP10 |
| Shielding connection available | Yes |
| Shield connection | Direct |
| Earthing via: | Connection cable / DIN rail |
| Testing standard | IEC 61643-21 |

Connection options

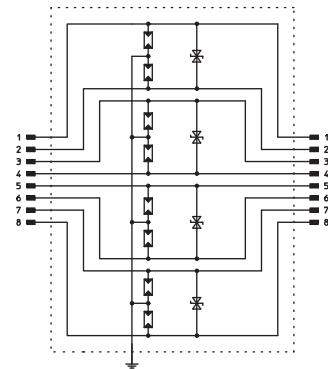

Alu



Surge protection for high-speed networks up to 1 GBit (Class ND-CAT6/E-F)

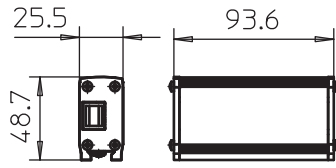

- Data cable protection device for high-speed networks
- High-quality RJ45 sockets
 - Low protection level at high current load
 - Earthing via DIN rail or connection cable
 - Support of Power over Ethernet ++ (PoE++/4PPoE) to 1 A in accordance with IEEE 802.3
 - Tested transmission quality in networks up to 1 GBit/s (Class E) or CAT6
 - Fast installation through plug-in version
 - Incl. DIN rail fastening set and earthing cable

Application example: 1 GBit Ethernet, 10/100 MBit Ethernet, PoE applications, IP camera systems, ISDN S0 interfaces

| Type | Version | Connection system | Pack Piece | Weight kg/100 pc. | Item no. |
|--------------------|-----------------------------------|-------------------|------------|-------------------|----------------|
| ND-CAT6/E-F | Fine protection, 8 wires + shield | RJ45 8(8) | 1 | 16.380 | 5081802 |

Connection options

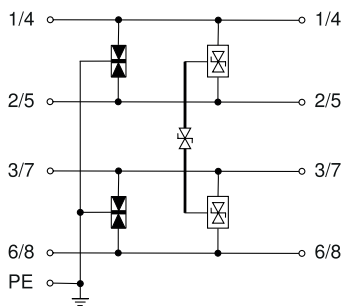

| ND-CAT6/E-F | |
|--------------------------------|-------------------------------------|
| Maximum continuous voltage AC | U_c 41 V |
| Maximum continuous voltage DC | U_c 58 V |
| Category | Type 2+3 / C2+C1 |
| Lightning protection zone LPZ | 1-3 |
| Channel performance ISO/IEC | Class E |
| Channel performance Ansi/EA | CAT 6 |
| Number of poles | 8 |
| Rated current | I_L 1 A |
| Impulse durability wire-wire | C1: 0,3 kV / 0,15 kA (8/20 μ s) |
| Impulse durability wire-earth | C2: 3 kV / 1,5 kA (8/20 μ s) |
| Total discharge current (8/20) | 5 kA |
| Protection level wire-wire | <40 V |
| Protection level wire-earth | <900 V |
| Frequency range | >250 MHz |
| Temperature range | ϑ -40 - +80 °C |
| Installation type | Connector/cable adapter |
| Connection system | RJ45 8(8) |
| Protection rating | IP10 |
| Shielding connection available | Yes |
| Shield connection | Direct |
| Earthing via: | Connection cable / DIN rail |
| Testing standard | IEC 61643-21 |

Schutzinstallationen: Überspannungsschutz und Explosionsschutz / en / 2021/06/25 09:52:32 (LLExpert_02926) / 2021/06/25

Surge protection



Surge protection for high-speed networks up to 1 GBit (Class ND-CAT6/E-B)

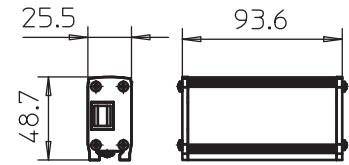

Surge protection

| Type | Version | Connection system | Pack Piece | Weight kg/100 pc. | Item no. |
|--------------------|------------------------------------|-------------------|------------|-------------------|----------------|
| ND-CAT6/E-B | Basic protection, 8 wires + shield | RJ45 8(8) | 1 | 16.220 | 5081804 |

- Data cable protection device for high-speed networks
- Protection class: Basic protection
 - High-quality RJ45 sockets
 - Low protection level at high current load
 - Earthing via DIN rail or connection cable
 - Support of Power over Ethernet ++ (PoE++/4PPoE) to 1 A in accordance with IEEE 802.3
 - Tested transmission quality in networks up to 1 GBit/s (Class E) or CAT6
 - Rapid installation through plug-in version
 - Incl. DIN rail fastening set and earthing cable

Application example: 1 GBit Ethernet, 10/100 MBit Ethernet, PoE applications, IP camera systems, ISDN S0 interfaces

| ND-CAT6/E-B | |
|-------------------------------------|----------------------------------|
| Maximum continuous voltage AC U_c | 46 V |
| Maximum continuous voltage DC U_c | 65 V |
| Category | Type 1 / D1 |
| Lightning protection zone LPZ | 0→1 |
| Channel performance ISO/IEC | Class E |
| Channel performance Ansi/EA | CAT 6 |
| Number of poles | 8 |
| Rated current I_L | 1 A |
| Impulse durability wire-wire | C2: 3 kV / 1,5 kA (8/20 μ s) |
| Impulse durability wire-earth | C2: 3 kV / 1,5 kA (8/20 μ s) |
| Total discharge current (8/20) | 10 kA |
| Protection level wire-wire | <1100 V |
| Protection level wire-earth | <900 V |
| Frequency range | >250 MHz |
| Temperature range ϑ | -40 - +80 °C |
| Installation type | Connector/cable adapter |
| Connection system | RJ45 8(8) |
| Protection rating | IP10 |
| Shielding connection available | Yes |
| Shield connection | Direct |
| Earthing via: | Connection cable / DIN rail |
| Testing standard | IEC 61643-21 |

Connection options

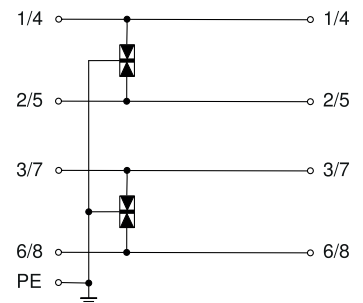



Combination arrester for 10Base2-/10Base5 networks

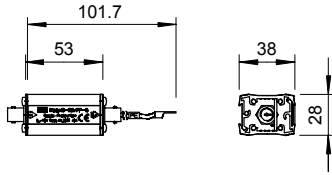

Data line protection device for coaxial Ethernet network systems

- In aluminium housing
- BNC connector m/f
- Simple mounting with adapter plug
- Two-stage protection circuit
- DIN rail mounting with DLS-BS accessories (5082 38 2)

Application: Protecting video signals; cameras and/or CCTV units, Cheapernet, 10BASE2, 10BASE5

| Type | Version | Connection system | Pack Piece | Weight kg/100 pc. | Item no. |
|----------------|------------------|-------------------|------------|-------------------|----------|
| KOAX B-E2 MF-C | Combi protection | BNC | 1 | 10.300 | 5082430 |

Connection options

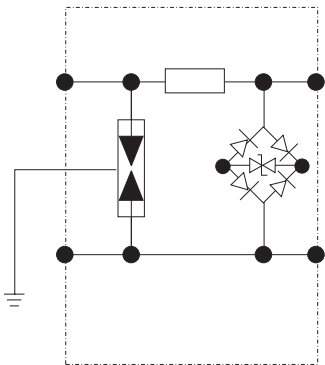

| KOAX B-E2 MF-C | | |
|------------------------------------|-------------|---------------------------------|
| Maximum continuous voltage AC | U_c | 4.2 V |
| Maximum continuous voltage DC | U_c | 6.2 V |
| Category | | Type 1+2+3 / D1+C2+C1 |
| Lightning protection zone LPZ | | 0→3 |
| Number of poles | | 1 |
| Rated current | I_L | 0.3 A |
| Series resistance per wire | | 4,7 Ω \pm 10% |
| Wave resistance | Z_L | 75 Ω |
| Impulse durability wire-wire | | C2: 10 kV / 5 kA (8/20 μ s) |
| Impulse durability wire-earth | | C2: 10 kV / 5 kA (8/20 μ s) |
| Impulse discharge current (10/350) | I_{imp} | 1 kA |
| Total discharge current (8/20) | | 10 kA |
| Total discharge current (10/350) | | 2 kA |
| Protection level wire-wire | | <75 V |
| Protection level wire-earth | | <600 V |
| Frequency range | | 0 - 68 MHz |
| Insertion loss | S_{21} | \leq 1,7 dB |
| Return loss | S_{11} | \geq 14 dB |
| Temperature range | ϑ | -20 - +80 °C |
| Installation type | | Connector/cable adapter |
| Connection system | | BNC |
| Protection rating | | IP40 |
| Shielding connection available | | Yes |
| Shield connection | | Direct |
| Earthing via: | | Connection cable |
| Testing standard | | IEC 61643-21 |



Fine protection for 10Base2-/10Base5 networks

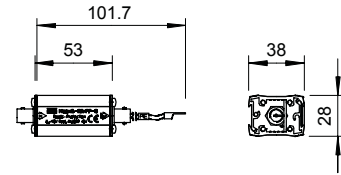

| Type | Version | Connection system | Pack Piece | Weight kg/100 pc. | Item no. |
|----------------|-----------------|-------------------|------------|-------------------|----------|
| KOAX B-E2 MF-F | Fine protection | BNC | 1 | 9.800 | 5082432 |

Data line protection device for coaxial Ethernet network systems

- In aluminium housing
- BNC connector m/f
- Simple mounting with adapter plug
- Two-stage protection circuit
- DIN rail mounting with DLS-BS accessories (5082 38 2)

Application: Protecting video signals; cameras and/or CCTV units, Cheapernet, 10BASE2, 10BASE5

KOAX B-E2 MF-F

| | |
|-------------------------------------|------------------------------------|
| Maximum continuous voltage AC U_c | 4.2 V |
| Maximum continuous voltage DC U_c | 6.2 V |
| Category | Type 2+3 / C2+C1 |
| Lightning protection zone LPZ | 1-3 |
| Number of poles | 1 |
| Rated current | I_L 1 A |
| Wave resistance | Z_L 75 Ω |
| Impulse durability wire-wire | C1: 1 kV / 0,5 kA (8/20 μ s) |
| Impulse durability wire-earth | C2: 10 kV / 5 kA (8/20 μ s) |
| Total discharge current (8/20) | 10 kA |
| Protection level wire-wire | <40 V |
| Protection level wire-earth | <600 V |
| Frequency range | 0 - 70 MHz |
| Insertion loss | S_{21} \leq 1 dB |
| Return loss | S_{11} \geq 14 dB |
| Temperature range | ϑ -20 - +80 $^{\circ}$ C |
| Installation type | Connector/cable adapter |
| Connection system | BNC |
| Protection rating | IP40 |
| Shielding connection available | Yes |
| Shield connection | Direct |
| Earthing via: | Connection cable |
| Testing standard | IEC 61643-21 |

Connection options

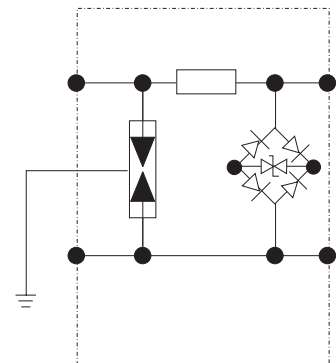



Data cable protection device for coaxial TV / camera systems

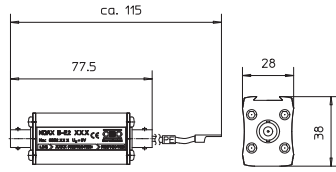

Data cable protection device for coaxial TV / camera systems

- In aluminium housing
- BNC connector socket/socket
- Simple mounting with adapter plug
- Two-stage protection circuit
- DIN rail mounting with DLS-BS accessories (5082 38 2)

Application: Protection of CCTV, video signals; cameras and/or TV systems

| Type | Version | Connection system | Pack Piece | Weight kg/100 pc. | Item no. |
|----------------|-----------------|-------------------|------------|-------------------|----------|
| KOAX B-E2 FF-F | Fine protection | BNC | 1 | 14.400 | 5082434 |

Connection options

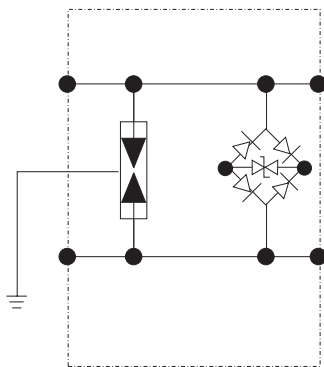

| KOAX B-E2 FF-F | |
|--------------------------------|----------------------------------|
| Maximum continuous voltage AC | U_c 4.2 V |
| Maximum continuous voltage DC | U_c 6.2 V |
| Category | Type 2+3 / C2+C1 |
| Lightning protection zone LPZ | 1→3 |
| Number of poles | 1 |
| Rated current | I_L 1 A |
| Wave resistance | Z_L 75 Ω |
| Impulse durability wire-wire | C1: 1 kV / 0,5 kA (8/20 μ s) |
| Impulse durability wire-earth | C2: 10 kV / 5 kA (8/20 μ s) |
| Total discharge current (8/20) | 10 kA |
| Protection level wire-wire | <40 V |
| Protection level wire-earth | <600 V |
| Frequency range | 0 - 160 MHz |
| Insertion loss | S_{21} \leq 1,7 dB |
| Return loss | S_{11} \geq 14 dB |
| Temperature range | ϑ -20 - +80 °C |
| Installation type | Connector/cable adapter |
| Connection system | BNC |
| Protection rating | IP40 |
| Shielding connection available | Yes |
| Shield connection | Direct |
| Earthing via: | Connection cable |
| Testing standard | IEC 61643-21 |



Fastening set for DIN profile rail

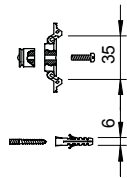

| Version | | Pack Piece | Weight kg/100 pc. | Item no. |
|---------------|--|------------|-------------------|----------------|
| Type | | | | |
| DLS-BS | For mounting: <ul style="list-style-type: none"> • Coax B-E2/... • Coax N-E5/... • RJ 11-Tele/4... • RJ45 S... | 1 | 5.000 | 5082382 |

DLS-BS: The fastening set is designed for a DIN rail and wall mounting and can be used for the data cable protection devices listed below:

- Coax N-E5/...
- Coax B-E2/...
- RJ 11-Tele/4...
- RJ 45 S-...





Combined protection device 2in1 for CCTV camera systems

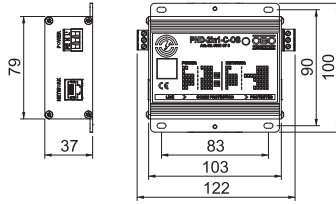

Combination protection device for IP-based TV/camera systems

- Protection of power and data interface in a single device
- In aluminium housing
- Simple mounting with adapter plug
- Two-stage protection circuit
- Three-pole power connection for the power interface
- RJ45 connection for the data interface
- With LED operation display (OS)
- Incl. DIN rail fastening set

Application: Protection of CCTV, video signals, (IP) cameras and/or TV systems

| Type | Maximum continuous voltage (L-N) V | Maximum discharge current (8/20 μs) kA | Pack Piece | Weight kg/100 pc. | Item no. |
|----------------------|------------------------------------|--|------------|-------------------|----------------|
| PND-2in1-C-OS | 255 | 10 | 1 | 27.000 | 5081070 |

Connection options

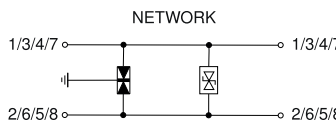
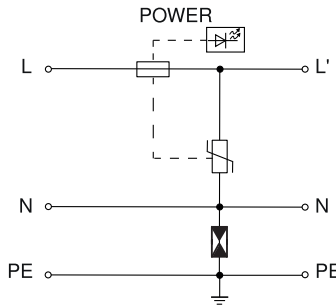

| PND-2in1-C-OS | |
|-------------------------------------|-------------------------------|
| Temperature range | θ -20 - +80 °C |
| Installation type | Installation |
| Protection rating | IP20 |
| Earthing via: | Connection cable / DIN rail |
| Lightning protection zone LPZ | 1→3 |
| Power | |
| SPD to IEC 61643-11 | Class II+III |
| SPD to EN 61643-11 | Type 2+3 |
| Maximum continuous voltage (L-N) | U_c 255 V |
| Rated current | I_L 16 A |
| Protection level | U_o <1,3 kV |
| Idle voltage | U_{oc} 10 kV |
| Nominal discharge current (8/20 μs) | $I_n / L-N$ 5 kA |
| Maximum discharge current (8/20 μs) | I_{max} 10 kA |
| Network | |
| Maximum continuous voltage AC | U_c 5.65 V |
| Maximum continuous voltage DC | U_c 8 V |
| Category | Type 1+2+3 / D1+C2+C1 |
| Impulse durability wire-wire | C1: 0,3 kV / 0,15 kA (8/20μs) |
| Impulse durability wire-earth | C2: 3 kV / 1,5 kA (8/20μs) |
| Protection level wire-wire | <40 V |
| Protection level wire-earth | <450 V |
| Frequency range | 0 - 100 MHz |
| Shielding connection available | Yes |
| Shield connection | Direct |
| Testing standard | IEC 61643-21 |



Combined protection device 3in1 for CCTV camera systems

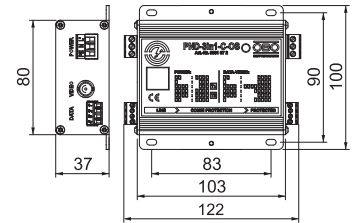

| Type | Maximum continuous voltage (L-N) V | Maximum discharge current (8/20 μs) kA | Pack Piece | Weight kg/100 pc. | Item no. |
|---------------|------------------------------------|--|------------|-------------------|----------|
| PND-3in1-C-OS | 255 | 10 | 1 | 29.900 | 5081072 |

Combination protection device for coaxial TV/camera systems

- Protection of power and data interfaces in a single device
- In aluminium housing
- Simple mounting with adapter
- Two-stage protection circuit
- Three-pole power connection for the power interface
- With LED operation display (OS)
- Incl. DIN rail fastening set

Application: Protection of CCTV, video signals, cameras and/or TV systems

| PND-3in1-C-OS | |
|-------------------------------------|-----------------------------|
| Lightning protection zone LPZ | 1-3 |
| Earthing via: | Connection cable / DIN rail |
| Protection rating | IP20 |
| Power | |
| SPD to IEC 61643-11 | Class II+III |
| SPD to EN 61643-11 | Type 2+3 |
| Maximum continuous voltage (L-N) | U_c 255 V |
| Rated current | I_L 16 A |
| Protection level | U_p <1,3 kV |
| Nominal discharge current (8/20 μs) | $I_n / L-N$ 5 kA |
| Maximum discharge current (8/20 μs) | I_{max} 10 kA |
| Data | |
| Maximum continuous voltage AC | U_c 5.65 V |
| Maximum continuous voltage DC | U_c 8 V |
| SPD to IEC 61643-21 | Class I+II / D1+C2 |
| Category | Type 1+2 / D1+C2 |
| Impulse durability wire-wire | C2: 10 kV / 5 kA (8/20μs) |
| Impulse durability wire-earth | C2: 10 kV / 5 kA (8/20μs) |
| Impulse current (10/350) | I_{imp} 1 kA |
| Protection level wire-earth | <450 V |
| Protection level wire-wire | <65 V |
| Frequency range | 0-100 MHz |
| Video | |
| Maximum continuous voltage AC | U_c 5.65 V |
| Maximum continuous voltage DC | U_c 8 V |
| SPD to IEC 61643-21 | Class I+II / D1+C2 |
| Category | Type 1+2 / D1+C2 |
| Impulse durability wire-earth | C2: 10 kV / 5 kA (8/20μs) |
| Impulse durability wire-wire | C2: 10 kV / 5 kA (8/20μs) |
| Impulse current (10/350) | I_{imp} 1 kA |
| Protection level wire-wire | <90 V |
| Protection level wire-earth | <150 V |
| Frequency range | 0-100 MHz |
| Screen connection | Yes |
| Screening | Direct |
| Temperature range | θ -20 - +80 °C |

Connection options

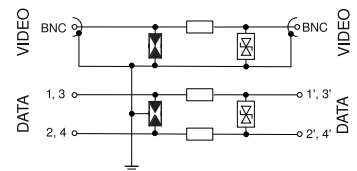
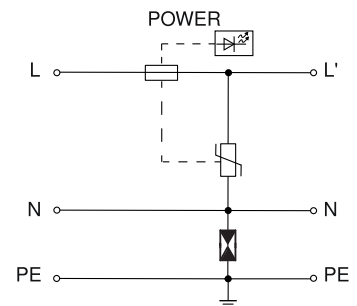



DS family

Coaxial protection devices for S-UHF, BNC, N, TNC, F and SMA connection

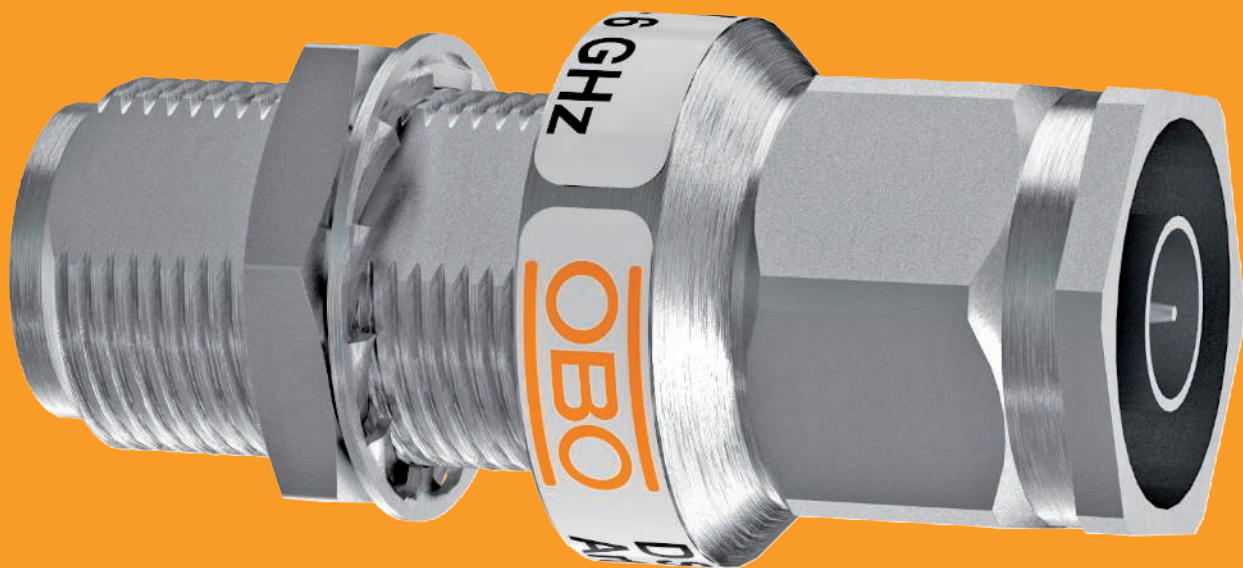

Surge protection



- Coaxial protection devices
- Optimum protection for sensitive systems
- Low insertion attenuation and low return loss at different wave resistances
- High bandwidth

The coaxial protection devices of type DS offer optimum protection of sensitive systems, based on coaxial plug connections. The low insertion attenuation and low return attenuation at different wave resistances offer ideal protection for any application. In accordance with their structure, the protec-

tion devices are switched into the application in series, and are connected to the local equipotential bonding. The direct shield earthing avoids reducing of the shield performance.



Coaxial protection devices for S-UHF connection: male/female

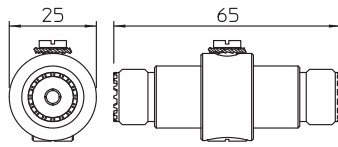

Coaxial data cable protection devices

- Basic protection
- High pulsed current carrying capacity 2 x 2.5 kA (10/350 μ s)
- Simple installation (adapter plug), m = male/f = female connector
- Various plug combinations
- With UHF connector
- Optimised transmission behaviour
- Including OBO M25 Quick clip for simple installation

| Type | Connection system | Frequency range | Pack Piece | Weight kg/100 pc. | Item no. |
|------------------|-------------------|-----------------|------------|-------------------|----------------|
| S-UHF M/W | UHF | 0 - 1,3 GHz | 1 | 7.000 | 5093023 |

Connection options

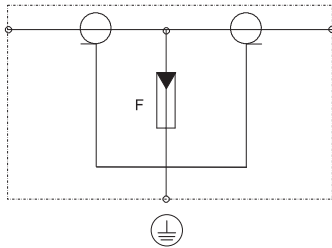

| S-UHF M/W | |
|------------------------------------|---------------------------------|
| Maximum continuous voltage AC | U_c 130 V |
| Maximum continuous voltage DC | U_c 185 V |
| Category | Type 1+2 / D1+C2 |
| Lightning protection zone LPZ | 0-2 |
| Number of poles | 1 |
| Rated current | I_L 10 A |
| Wave resistance | Z_L 50 Ω |
| Impulse durability wire-wire | C2: 10 kV / 5 kA (8/20 μ s) |
| Impulse durability wire-earth | C2: 10 kV / 5 kA (8/20 μ s) |
| Impulse discharge current (10/350) | I_{imp} 2.5 kA |
| Total discharge current (8/20) | 10 kA |
| Total discharge current (10/350) | 5 kA |
| Protection level | <800 V |
| Frequency range | 0 - 1,3 GHz |
| Insertion loss | S_{21} \leq 0,2 dB |
| Return loss | S_{11} \geq 14 dB |
| Temperature range | ϑ -40 - +80 °C |
| Installation type | Connector/cable adapter |
| Connection system | UHF |
| Protection rating | IP40 |
| Shielding connection available | Yes |
| Shield connection | Direct |
| Testing standard | IEC 61643-21 |



Coaxial protection devices for S-UHF connection: female/female

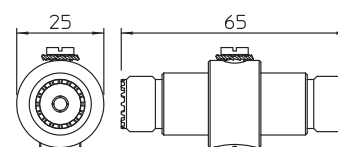

| Type | Connection system | Frequency range | Pack Piece | Weight kg/100 pc. | Item no. |
|-----------|-------------------|-----------------|------------|-------------------|----------|
| S-UHF W/W | UHF | 0-1,3 GHz | 1 | 7.000 | 5093015 |

- Coaxial data cable protection devices
- Basic protection
 - High pulsed current carrying capacity 2 x 2.5 kA (10/350 μs)
 - Simple installation (adapter plug), m = male/f = female connector
 - Various plug combinations
 - With UHF connector
 - Optimised transmission behaviour
 - Including OBO M25 Quick clip for simple installation

| S-UHF W/W | |
|------------------------------------|---------------------------|
| Maximum continuous voltage AC | U_c 130 V |
| Maximum continuous voltage DC | U_c 185 V |
| Category | Type 1+2 / D1+C2 |
| Lightning protection zone LPZ | 0-2 |
| Number of poles | 1 |
| Rated current | I_L 10 A |
| Wave resistance | Z_L 50 Ω |
| Impulse durability wire-wire | C2: 10 kV / 5 kA (8/20μs) |
| Impulse durability wire-earth | C2: 10 kV / 5 kA (8/20μs) |
| Impulse discharge current (10/350) | I_{imp} 2.5 kA |
| Total discharge current (8/20) | 10 kA |
| Total discharge current (10/350) | 5 kA |
| Protection level | <800 V |
| Frequency range | 0 - 1,3 GHz |
| Insertion loss | S_{21} ≤0,2 dB |
| Return loss | S_{11} ≥14 dB |
| Temperature range | θ -40 - +80 °C |
| Installation type | Connector/cable adapter |
| Connection system | UHF |
| Protection rating | IP40 |
| Shielding connection available | Yes |
| Shield connection | Direct |
| Testing standard | IEC 61643-21 |

Connection options

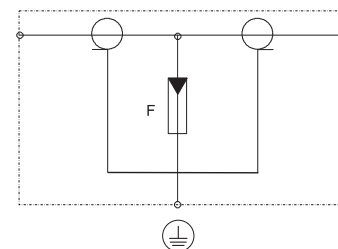



Coaxial protection device for BNC connection: male/female

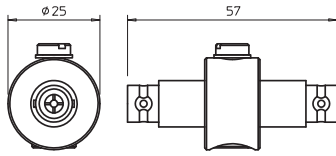

Coaxial data cable protection devices

- Basic protection
- High pulsed current carrying capacity 2 x 2.5 kA (10/350 μ s)
- Simple installation (adapter plug), m = plug/f = female connector
- Various plug combinations
- With BNC connector
- Optimised transmission behaviour
- Including OBO M25 Quick clip for simple installation

| Type | Connection system | Frequency range | Pack Piece | Weight kg/100 pc. | Item no. |
|-------------------|-------------------|-----------------|------------|-------------------|----------------|
| DS-BNC M/W | BNC | 0 - 2,2 GHz | 1 | 6.500 | 5093252 |

Connection options

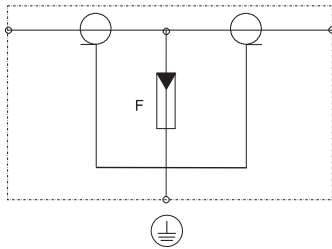

DS-BNC M/W

| | | |
|------------------------------------|-------------|---------------------------------|
| Maximum continuous voltage AC | U_c | 130 V |
| Maximum continuous voltage DC | U_c | 185 V |
| Category | | Type 1+2 / D1+C2 |
| Lightning protection zone LPZ | | 0-2 |
| Number of poles | | 1 |
| Rated current | I_L | 10 A |
| Wave resistance | Z_L | 50 Ω |
| Impulse durability wire-wire | | C2: 10 kV / 5 kA (8/20 μ s) |
| Impulse durability wire-earth | | C2: 10 kV / 5 kA (8/20 μ s) |
| Impulse discharge current (10/350) | I_{imp} | 2.5 kA |
| Total discharge current (8/20) | | 10 kA |
| Total discharge current (10/350) | | 5 kA |
| Protection level | | <800 V |
| Frequency range | | 0 - 2,2 GHz |
| Insertion loss | S_{21} | $\leq 0,95$ dB |
| Return loss | S_{11} | ≥ 14 dB |
| Temperature range | ϑ | -40 - +80 $^{\circ}$ C |
| Installation type | | Connector/cable adapter |
| Connection system | | BNC |
| Protection rating | | IP40 |
| Shielding connection available | | Yes |
| Shield connection | | Direct |
| Testing standard | | IEC 61643-21 |



Coaxial protection device for BNC connection: female/female

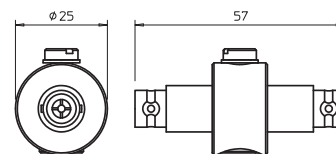

| Type | Connection system | Frequency range | Pack Piece | Weight kg/100 pc. | Item no. |
|------------|-------------------|-----------------|------------|-------------------|----------|
| DS-BNC W/W | BNC | 0-2,2 GHz | 1 | 6.000 | 5093236 |

Coaxial data cable protection devices

- Basic protection
- High pulsed current carrying capacity 2 x 2.5 kA (10/350 μs)
- Simple installation (adapter plug), m = plug/f = female connector
- Various plug combinations
- With BNC connector
- Optimised transmission behaviour
- Including OBO M25 Quick clip for simple installation

DS-BNC W/W

| | | |
|------------------------------------|-------------|---------------------------|
| Maximum continuous voltage AC | U_c | 130 V |
| Maximum continuous voltage DC | U_c | 185 V |
| Category | | Type 1+2 / D1+C2 |
| Lightning protection zone LPZ | | 0-2 |
| Number of poles | | 1 |
| Rated current | I_L | 10 A |
| Wave resistance | Z_L | 50 Ω |
| Impulse durability wire-wire | | C2: 10 kV / 5 kA (8/20μs) |
| Impulse durability wire-earth | | C2: 10 kV / 5 kA (8/20μs) |
| Impulse discharge current (10/350) | I_{imp} | 2.5 kA |
| Total discharge current (8/20) | | 10 kA |
| Total discharge current (10/350) | | 5 kA |
| Protection level | | <800 V |
| Frequency range | | 0 - 2,2 GHz |
| Insertion loss | S_{21} | ≤0,95 dB |
| Return loss | S_{11} | ≥14 dB |
| Temperature range | ϑ | -40 - +80 °C |
| Installation type | | Connector/cable adapter |
| Connection system | | BNC |
| Protection rating | | IP40 |
| Shielding connection available | | Yes |
| Shield connection | | Direct |
| Testing standard | | IEC 61643-21 |

Connection options

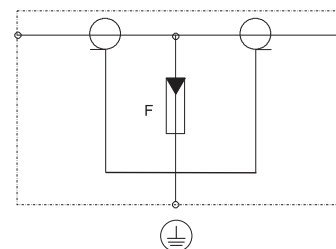



Coaxial protection device for BNC connection: male/male

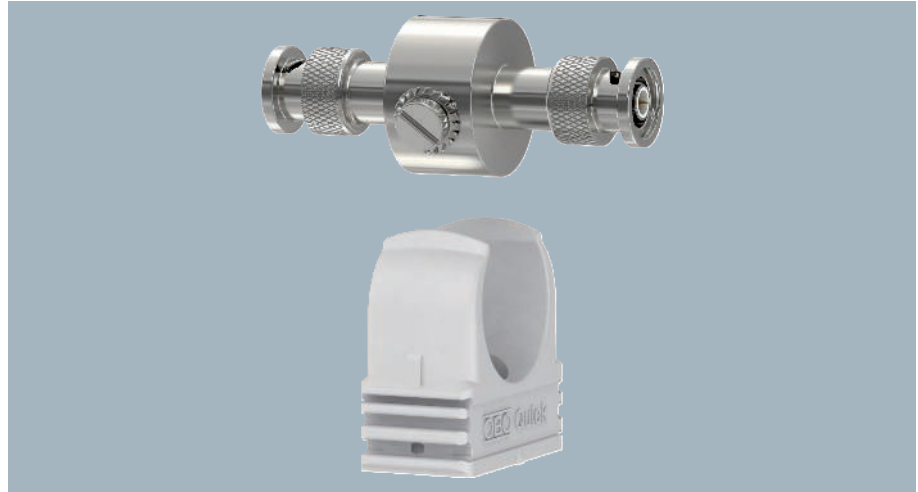
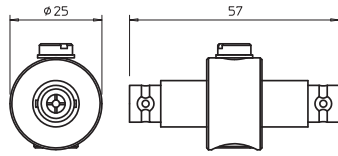

Coaxial data cable protection devices

- Basic protection
- High pulsed current carrying capacity 2 x 2.5 kA (10/350 μ s)
- Simple installation (adapter plug), m = plug/f = female connector
- Various plug combinations
- With BNC connector
- Optimised transmission behaviour
- Including OBO M25 Quick clip for simple installation

| Type | Con- nection system | Frequency range | Pack Piece | Weight kg/100 pc. | Item no. |
|-------------------|---------------------------|--------------------|---------------|----------------------|----------------|
| DS-BNC M/M | BNC | 0-2,2 GHz | 1 | 7.000 | 5093260 |

Connection options

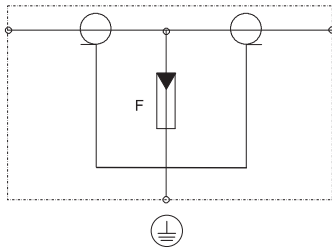

| DS-BNC M/M | |
|------------------------------------|------------------------------------|
| Maximum continuous voltage AC | U_c 130 V |
| Maximum continuous voltage DC | U_c 185 V |
| Category | Type 1+2 / D1+C2 |
| Lightning protection zone LPZ | 0-2 |
| Number of poles | 1 |
| Rated current | I_L 10 A |
| Wave resistance | Z_L 50 Ω |
| Impulse durability wire-wire | C2: 10 kV / 5 kA (8/20 μ s) |
| Impulse durability wire-earth | C2: 10 kV / 5 kA (8/20 μ s) |
| Impulse discharge current (10/350) | I_{imp} 2.5 kA |
| Total discharge current (8/20) | 10 kA |
| Total discharge current (10/350) | 5 kA |
| Protection level | <800 V |
| Frequency range | 0 - 2,2 GHz |
| Insertion loss | S_{21} \leq 0,95 dB |
| Return loss | S_{11} \geq 14 dB |
| Temperature range | ϑ -40 - +80 $^{\circ}$ C |
| Installation type | Connector/cable adapter |
| Connection system | BNC |
| Protection rating | IP40 |
| Shielding connection available | Yes |
| Shield connection | Direct |
| Testing standard | IEC 61643-21 |



Coaxial protection device for N connection: male/female

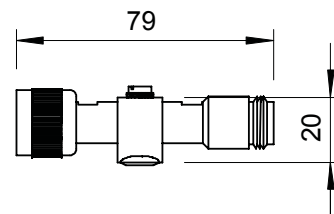

| Type | Connection system | Frequency range | Pack Piece | Weight kg/100 pc. | Item no. |
|----------|-------------------|-----------------|------------|-------------------|----------|
| DS-N M/W | N | 0-3 GHz | 1 | 12.200 | 5093996 |

- Coaxial data cable protection devices
- High pulsed current carrying capacity 2 x 2.5 kA (10/350)
 - Simple mounting (adapter plug), m = plug/f = female connector
 - Optimised transmission behaviour
 - 5-year guarantee
 - With N connector
 - Including OBO M25 Quick clip for simple installation

| DS-N M/W | |
|------------------------------------|---------------------------------|
| Maximum continuous voltage AC | U_c 130 V |
| Maximum continuous voltage DC | U_c 185 V |
| Category | Type 1+2 / D1+C2 |
| Lightning protection zone LPZ | 0-2 |
| Number of poles | 1 |
| Rated current | I_L 10 A |
| Wave resistance | Z_L 50 Ω |
| Impulse durability wire-wire | C2: 10 kV / 5 kA (8/20 μ s) |
| Impulse durability wire-earth | C2: 10 kV / 5 kA (8/20 μ s) |
| Impulse discharge current (10/350) | I_{imp} 2.5 kA |
| Total discharge current (8/20) | 10 kA |
| Total discharge current (10/350) | 5 kA |
| Protection level | <800 V |
| Frequency range | 0 - 3 GHz |
| Insertion loss | S_{21} \leq 0,62 dB |
| Return loss | S_{11} \geq 14 dB |
| Temperature range | ϑ -40 - +80 °C |
| Installation type | Connector/cable adapter |
| Connection system | N |
| Protection rating | IP40 |
| Shielding connection available | Yes |
| Shield connection | Direct |
| Testing standard | IEC 61643-21 |

Connection options

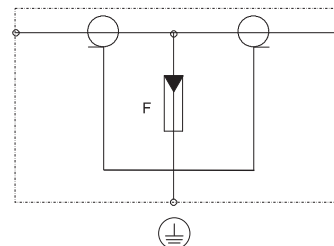

Surge protection



Coaxial protection device for N connection: female/female

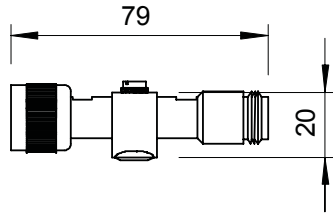

Coaxial data cable protection devices

- High pulsed current carrying capacity 2 x 2.5 kA (10/350)
- Simple mounting (adapter plug), m = plug/f = female connector
- Optimised transmission behaviour
- 5-year guarantee
- With N connector
- Including OBO M25 Quick clip for simple installation

| Type | Con- tion system | Frequency range | Pack Piece | Weight kg/100 pc. | Item no. |
|----------|------------------------|--------------------|---------------|----------------------|----------|
| DS-N W/W | N | 0-3 GHz | 1 | 11.500 | 5093988 |

Connection options

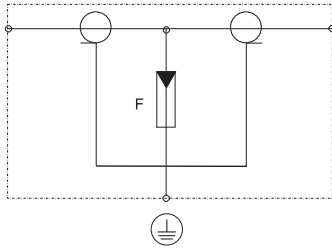

DS-N W/W

| | | |
|------------------------------------|-----------|---------------------------------|
| Maximum continuous voltage AC | U_c | 130 V |
| Maximum continuous voltage DC | U_c | 185 V |
| Category | | Type 1+2 / D1+C2 |
| Lightning protection zone LPZ | | 0-2 |
| Number of poles | | 1 |
| Rated current | I_L | 10 A |
| Wave resistance | Z_L | 50 Ω |
| Impulse durability wire-wire | | C2: 10 kV / 5 kA (8/20 μ s) |
| Impulse durability wire-earth | | C2: 10 kV / 5 kA (8/20 μ s) |
| Impulse discharge current (10/350) | I_{imp} | 2.5 kA |
| Total discharge current (8/20) | | 10 kA |
| Total discharge current (10/350) | | 5 kA |
| Protection level | | <800 V |
| Frequency range | | 0 - 3 GHz |
| Insertion loss | S_{21} | $\leq 0,62$ dB |
| Return loss | S_{11} | ≥ 14 dB |
| Temperature range | θ | -40 - +80 °C |
| Installation type | | Connector/cable adapter |
| Connection system | | N |
| Protection rating | | IP40 |
| Shielding connection available | | Yes |
| Shield connection | | Direct |
| Testing standard | | IEC 61643-21 |



Coaxial protection device for N connection up to 6 GHz: male/female

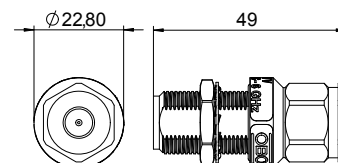

| Type | Connection system | Frequency range | Pack Piece | Weight kg/100 pc. | Item no. |
|------------|-------------------|-----------------|------------|-------------------|----------|
| DS-N-6 M/W | N | 0-6 GHz | 1 | 7.830 | 5093998 |

Coaxial data cable protection devices for transmission and reception technology

- With N-Connector, male/female
- High impulse current load capacity: 2.5 kA (10/350)
- Simple mounting (adapter), m = connector, w = socket
- Low protection level at high current loads
- Optimum transmission behaviour:
 - Low reflection behaviour
 - Bandwidth-optimised for secure transmission up to 6 GHz
- Available in 50 Ω technology

Application: For example: SAT-TV C band, WIMAX, WLAN applications, DVB-T2

| DS-N-6 M/W | |
|------------------------------------|---------------------------|
| Maximum continuous voltage AC | U_c 50 V |
| Maximum continuous voltage DC | U_c 70 V |
| Category | Type 1+2 / D1+C2 |
| Lightning protection zone LPZ | 0-2 |
| Number of poles | 1 |
| Rated current | I_L 10 A |
| Wave resistance | Z_L 50 Ω |
| Impulse durability wire-wire | C2: 10 kV / 5 kA (8/20μs) |
| Impulse durability wire-earth | C2: 10 kV / 5 kA (8/20μs) |
| Impulse discharge current (10/350) | I_{imp} 2.5 kA |
| Protection level | <750 V |
| Frequency range | 0 - 6 GHz |
| Insertion loss | S_{21} ≤0,1 dB |
| Return loss | S_{11} ≥22 dB |
| Temperature range | θ -40 - +80 °C |
| Installation type | Connector/cable adapter |
| Connection system | N |
| Protection rating | IP65/67 |
| Shielding connection available | Yes |
| Shield connection | Direct |
| Testing standard | IEC 61643-21 |

Connection options

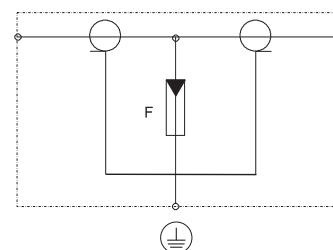



Coaxial protection device for TNC connection: male/female

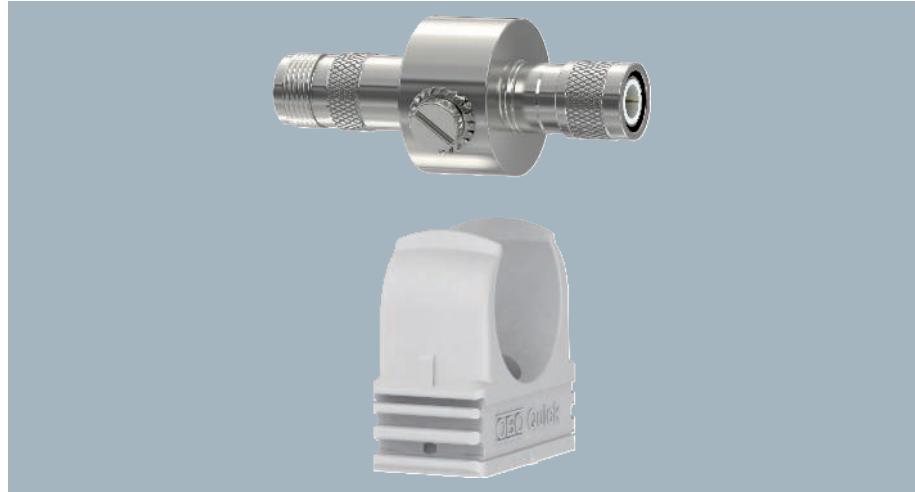
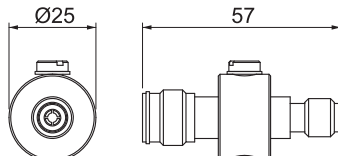

Coaxial data cable protection devices

- Basic protection
- High pulsed current carrying capacity 2 x 2.5 kA (10/350 μ s)
- Simple installation (adapter plug), m = plug/f = female connector
- Various plug combinations
- With TNC connector
- Optimised transmission behaviour
- Including OBO M25 Quick clip for simple installation

| Type | Con- tion system | Frequency range | Pack Piece | Weight kg/100 pc. | Item no. |
|-------------------|------------------------|--------------------|---------------|----------------------|----------------|
| DS-TNC M/W | TNC | 0-4 GHz | 1 | 7.953 | 5093270 |

Connection options

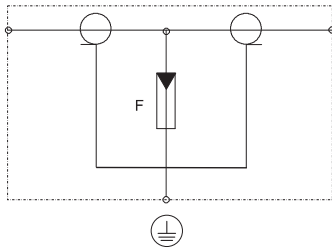

DS-TNC M/W

| | | |
|------------------------------------|-------------|---------------------------------|
| Maximum continuous voltage AC | U_c | 130 V |
| Maximum continuous voltage DC | U_c | 185 V |
| Category | | Type 1+2 / D1+C2 |
| Lightning protection zone LPZ | | 0-2 |
| Number of poles | | 1 |
| Rated current | I_L | 10 A |
| Wave resistance | Z_L | 50 Ω |
| Impulse durability wire-wire | | C2: 10 kV / 5 kA (8/20 μ s) |
| Impulse durability wire-earth | | C2: 10 kV / 5 kA (8/20 μ s) |
| Impulse discharge current (10/350) | I_{imp} | 2.5 kA |
| Total discharge current (8/20) | | 10 kA |
| Total discharge current (10/350) | | 5 kA |
| Protection level | | <800 V |
| Frequency range | | 0 - 4 GHz |
| Insertion loss | S_{21} | $\leq 0,5$ dB |
| Return loss | S_{11} | ≥ 14 dB |
| Temperature range | ϑ | -40 - +80 °C |
| Installation type | | Connector/cable adapter |
| Connection system | | TNC |
| Protection rating | | IP40 |
| Shielding connection available | | Yes |
| Shield connection | | Direct |
| Testing standard | | IEC 61643-21 |



Coaxial protection device for 7/16 connection: male/female

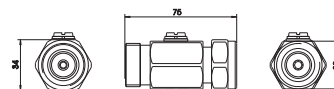
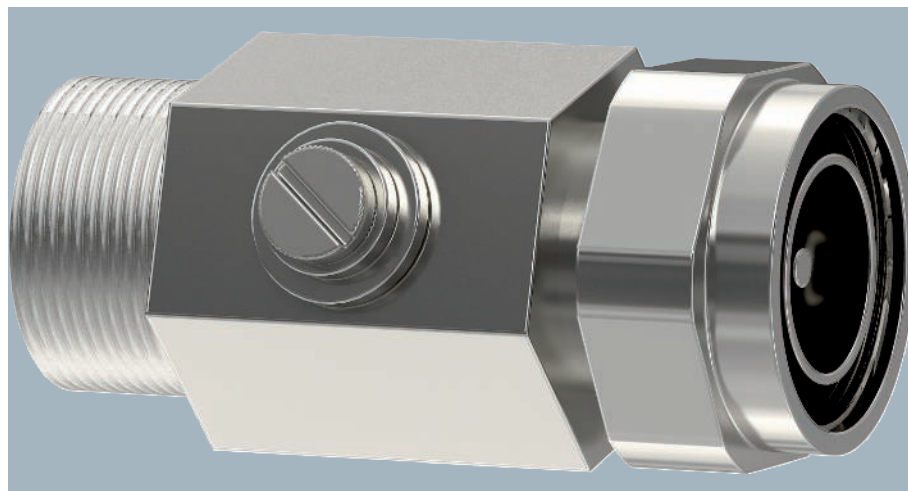

| Type | Connection system | Frequency range | Pack Piece | Weight kg/100 pc. | Item no. |
|--------------------|-------------------|-----------------|------------|-------------------|----------------|
| DS-7 16 M/W | 7/16 | 0-3GHz | 1 | 35.500 | 5093171 |

Coaxial data protection device

- Basic protection
- Simple mounting (adapter)
- Optimum transmission
- High pulse load capacity
- With 7/16 connector

Application: to protect mobile telephony applications.

DS-7 16 M/W

| | | |
|------------------------------------|-------------|---------------------------------|
| Maximum continuous voltage AC | U_c | 130 V |
| Maximum continuous voltage DC | U_c | 185 V |
| Category | | Type 1+2 / D1+C2 |
| Lightning protection zone LPZ | | 0→2 |
| Number of poles | | 1 |
| Rated current | I_L | 10 A |
| Wave resistance | Z_L | 50 Ω |
| Impulse durability wire-wire | | C2: 10 kV / 5 kA (8/20 μ s) |
| Impulse durability wire-earth | | C2: 10 kV / 5 kA (8/20 μ s) |
| Impulse discharge current (10/350) | I_{imp} | 2.5 kA |
| Total discharge current (8/20) | | 10 kA |
| Total discharge current (10/350) | | 5 kA |
| Protection level | | <800 V |
| Frequency range | | 0 - 3 GHz |
| Insertion loss | S_{21} | $\leq 0,95$ dB |
| Return loss | S_{11} | ≥ 14 dB |
| Temperature range | ϑ | -40 - +80 °C |
| Installation type | | Connector/cable adapter |
| Connection system | | 7/16 |
| Protection rating | | IP40 |
| Shielding connection available | | Yes |
| Shield connection | | Direct |
| Testing standard | | IEC 61643-21 |

Connection options

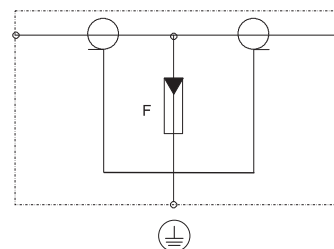



Coaxial protection device for F connection: male/female

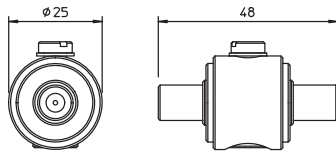

Coaxial data cable protection devices

- Basic protection
- High pulsed current carrying capacity 2 x 2.5 kA (10/350 μ s)
- Simple installation (adapter plug), m = plug/f = female connector
- Various plug combinations
- With F connector
- Optimised transmission behaviour
- Including OBO M25 Quick clip for simple installation

Application: Protection of TV and SAT systems, multi-switches, receivers and DVB-T(2)

| Type | Connection system | Frequency range | Pack Piece | Weight kg/100 pc. | Item no. |
|---------|-------------------|-----------------|------------|-------------------|----------|
| DS-F MW | F | 0-3,4 GHz | 1 | 9.000 | 5093275 |

Connection options

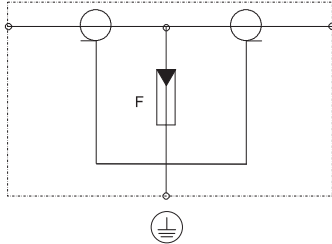

DS-F MW

| | | |
|------------------------------------|-------------|---------------------------------|
| Maximum continuous voltage AC | U_C | 130 V |
| Maximum continuous voltage DC | U_C | 185 V |
| Category | | Type 1+2 / D1+C2 |
| Lightning protection zone LPZ | | 0-2 |
| Number of poles | | 1 |
| Rated current | I_L | 5 A |
| Wave resistance | Z_L | 75 Ω |
| Impulse durability wire-wire | | C2: 10 kV / 5 kA (8/20 μ s) |
| Impulse durability wire-earth | | C2: 10 kV / 5 kA (8/20 μ s) |
| Impulse discharge current (10/350) | I_{imp} | 1 kA |
| Total discharge current (8/20) | | 10 kA |
| Total discharge current (10/350) | | 2 kA |
| Protection level | | <800 V |
| Frequency range | | 0 - 3,4 GHz |
| Insertion loss | S_{21} | $\leq 0,9$ dB |
| Return loss | S_{11} | ≥ 14 dB |
| Temperature range | ϑ | -40 - +80 $^{\circ}$ C |
| Installation type | | Connector/cable adapter |
| Connection system | | F |
| Protection rating | | IP40 |
| Shielding connection available | | Yes |
| Shield connection | | Direct |
| Testing standard | | IEC 61643-21 |



Coaxial protection device for F connection: fe-male/female

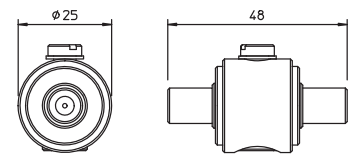

| Type | Connection system | Frequency range | Pack Piece | Weight kg/100 pc. | Item no. |
|----------|-------------------|-----------------|------------|-------------------|----------|
| DS-F W/W | F | 0-3,4 GHz | 1 | 9.000 | 5093272 |

Coaxial data cable protection devices

- Basic protection
- High pulsed current carrying capacity 2 x 2.5 kA (10/350 μs)
- Simple installation (adapter plug), m = plug/f = female connector
- Various plug combinations
- With F connector
- Optimised transmission behaviour
- Including OBO M25 Quick clip for simple installation

Application: Protection of TV and SAT systems, multi-switches, receivers and DVB-T(2)

| DS-F W/W | |
|------------------------------------|---------------------------|
| Maximum continuous voltage AC | U_c 130 V |
| Maximum continuous voltage DC | U_c 185 V |
| Category | Type 1+2 / D1+C2 |
| Lightning protection zone LPZ | 0→2 |
| Number of poles | 1 |
| Rated current | I_L 5 A |
| Wave resistance | Z_L 75 Ω |
| Impulse durability wire-wire | C2: 10 kV / 5 kA (8/20μs) |
| Impulse durability wire-earth | C2: 10 kV / 5 kA (8/20μs) |
| Impulse discharge current (10/350) | I_{imp} 1 kA |
| Total discharge current (8/20) | 10 kA |
| Total discharge current (10/350) | 2 kA |
| Protection level | <800 V |
| Frequency range | 0 - 3,4 GHz |
| Insertion loss | S_{21} ≤0,9 dB |
| Return loss | S_{11} ≥14 dB |
| Temperature range | θ -40 - +80 °C |
| Installation type | Connector/cable adapter |
| Connection system | F |
| Protection rating | IP40 |
| Shielding connection available | Yes |
| Shield connection | Direct |
| Testing standard | IEC 61643-21 |

Connection options

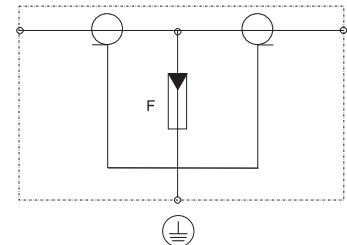



Coaxial protection device for SMA connection: female/female

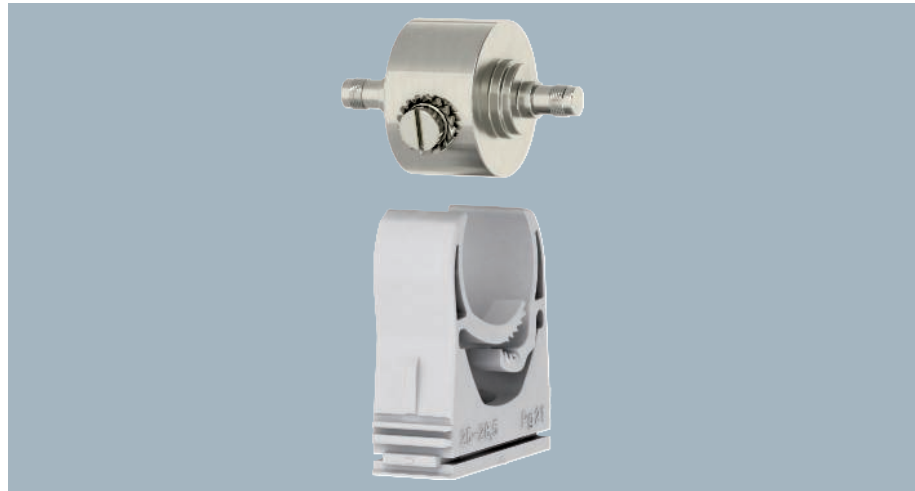
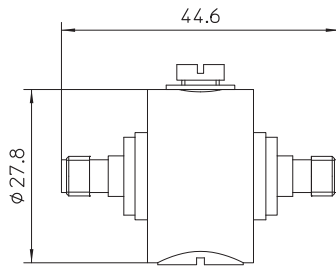

Coaxial data cable protection devices

- High pulse current carrying capacity $2 \times 2.5 \text{ kA}$ (10/350)
- Simple mounting (adapter connector), m = connector, f = socket
- Optimised transmission behaviour
- 5-year guarantee
- With SMA connector
- Including OBO Multi-Quick clip 25-28 for simple installation
- 50Ω technology

Application: Radio and data technology with SMA connector

| Type | Connection system | Frequency range | Pack Piece | Weight kg/100 pc. | Item no. |
|------------|-------------------|-----------------|------------|-------------------|----------|
| DS-SMA W/W | SMA | 0 - 3,7 GHz | 1 | 7.500 | 5093277 |

Connection options

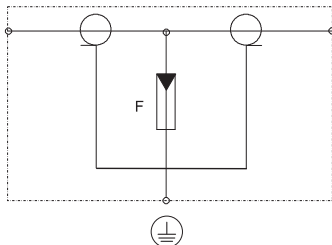

| DS-SMA W/W | |
|------------------------------------|---------------------------------|
| Maximum continuous voltage AC | U_c 130 V |
| Maximum continuous voltage DC | U_c 185 V |
| Category | Type 1+2 / D1+C2 |
| Lightning protection zone LPZ | 0→2 |
| Number of poles | 1 |
| Rated current | I_L 10 A |
| Wave resistance | Z_L 50 Ω |
| Impulse durability wire-wire | C2: 10 kV / 5 kA (8/20 μ s) |
| Impulse durability wire-earth | C2: 10 kV / 5 kA (8/20 μ s) |
| Impulse discharge current (10/350) | I_{imp} 2.5 kA |
| Total discharge current (8/20) | 10 kA |
| Total discharge current (10/350) | 5 kA |
| Protection level | <800 V |
| Frequency range | 0 - 3,7 GHz |
| Insertion loss | S_{21} $\leq 0,2$ dB |
| Return loss | S_{11} ≥ 14 dB |
| Temperature range | ϑ -40 - +80 °C |
| Installation type | Connector/cable adapter |
| Connection system | SMA |
| Protection rating | IP40 |
| Shielding connection available | Yes |
| Shield connection | Direct |
| Testing standard | IEC 61643-21 |



Coaxial protection device for SAT and cable multi-switch

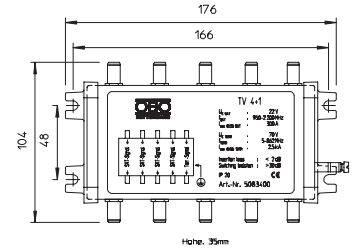

| Type | Connection system | Frequency range | Connection system | Pack Piece | Weight kg/100 pc. | Item no. |
|--------|-------------------|-----------------|-------------------|------------|-------------------|----------|
| TV 4+1 | F | 0,5-2,8 GHz | F | 1 | 37.000 | 5083400 |

Coaxial data line protection for TV reception systems

- Protects up to four SAT lines
- Protects one terrestrial line, e.g. DVB-T.
- Simple mounting using screws and holder
- With F-connector
- Optimum transmission behaviour with 75 Ohm technology.

Application: Protection of TV and SAT systems, multi-switches, receivers and DVB-T receivers

| TV 4+1 | | |
|---|------------------|------------------|
| Maximum continuous voltage Vc SAT inputs | U _C | 22 V |
| Maximum continuous voltage Vc terrestrial input | U _C | 70 V |
| Category | | Type 2+3 / C2+C1 |
| Lightning protection zone LPZ | | 1-3 |
| Number of poles | | 5 |
| Rated current | I _L | 2 A |
| Wave resistance | Z _L | 75 Ω |
| Nominal discharge current SAT inputs | I _n | 300 A |
| Lightning impulse current terrestrial input | I _{imp} | 1 kA |
| Protection level SAT inputs at In | U _d | <45 V |
| Protection level Terrestrial input at In | | <500 V |
| Frequency range | | 0,5 - 2,8 GHz |
| Insertion loss | S ₂₁ | ≤3 dB |
| Return loss | S ₁₁ | >30 dB |
| Temperature range | θ | -40 - +80 °C |
| Installation type | | Surface-mounted |
| Connection system | | F |
| Protection rating | | IP10 |
| Shielding connection available | | Yes |
| Shield connection | | Direct |
| Earthing via: | | Connection cable |
| Testing standard | | IEC 61643-21 |

Connection options

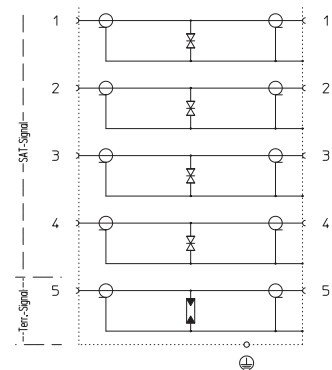



Surge protective devices for photovoltaic applications

Type 1+2 and type 2 for 1,000 V and 1,500 V DC



Surge protection



- Surge protection according to EN/IEC 60364-7-712 (VDE 0100-712)
- Error-resistant Y circuit with status display
- The FS variant has a potential-free changeover contact for remote signalling



Type 1+2 1000 V



Type 2 1500 V



PV complete block 1500 V DC

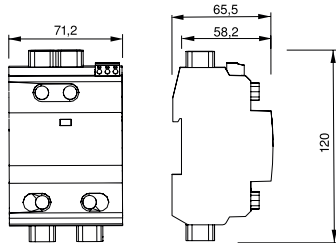

Type 1+2 combination arrester for lightning and surge protection of PV systems.

- Lightning protection equipotential bonding according to IEC 62305 (VDE 0185-305)
- Surge protection according to IEC 60364-7-712 (VDE 0100-712)
- Arresting capacity to 12.5 kA (10/350) and 40 kA (8/20)
- Error-resistant Y circuit with status display
- The FS variant possesses a potential-free changeover contact for remote signalling

Application: Lightning current and surge protective devices for PV systems.

| Type | U max DC V | Version | Pack Piece | Weight kg/100 pc. | Item no. |
|----------------|------------|-----------------|------------|-------------------|----------|
| V-PV-T1+2-1500 | 1500 | Y configuration | 1 | 49.200 | 5094240 |

Connection options

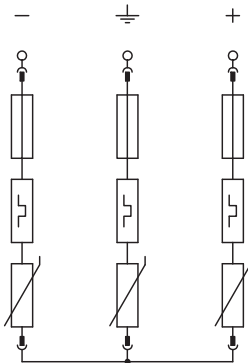

| V-PV-T1+2-1500 | |
|--------------------------------------|--------------------------|
| U max DC | U _c DC 1500 V |
| SPD to EN 61643-11 | Type 1+2 |
| Lightning protection zone LPZ | 0→2 |
| Impulse discharge current (10/350) | I _{imp} 6.25 kA |
| Nominal discharge current (8/20) | I _n 20 kA |
| Maximum discharge current (8/20 μs) | I _{max} 40 kA |
| Protection level | U _p < 4,5 kV |
| Response time | t _A < 25 ns |
| Temperature range | θ -40 - 80 °C |
| Protection rating | IP20 |
| Division unit TE (17.5 mm) | 4 |
| Connection cross-section, rigid | 2.5 - 35 mm ² |
| Connection cross-section, multi-wire | 2.5 - 35 mm ² |
| Connection cross-section, flexible | 2.5 - 35 mm ² |



PV complete block 1500 V DC with remote signalling

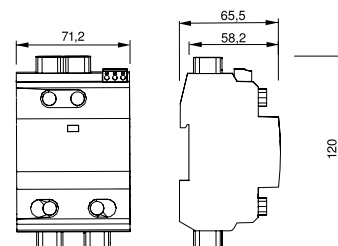

| Type | U max DC V | Version | Pack Piece | Weight kg/100 pc. | Item no. |
|------------------|------------|----------------------|------------|-------------------|----------|
| V-PV-T1+2-1500FS | 1500 | Y configuration + RS | 1 | 49.600 | 5094242 |

Type 1+2 combination arrester for lightning and surge protection of PV systems.

- Lightning protection equipotential bonding according to IEC 62305 (VDE 0185-305)
- Surge protection according to IEC 60364-7-712 (VDE 0100-712)
- Arresting capacity to 12.5 kA (10/350) and 40 kA (8/20)
- Error-resistant Y circuit with status display
- The FS variant possesses a potential-free changeover contact for remote signalling

Application: Lightning current and surge protective devices for PV systems.

| V-PV-T1+2-1500FS | |
|--------------------------------------|--------------------------|
| U max DC | U _c DC 1500 V |
| SPD to EN 61643-11 | Type 1+2 |
| Lightning protection zone LPZ | 0→2 |
| Impulse discharge current (10/350) | I _{imp} 6.25 kA |
| Nominal discharge current (8/20) | I _n 20 kA |
| Maximum discharge current (8/20 μs) | I _{max} 40 kA |
| Protection level | U _p < 4,5 kV |
| Response time | t _A < 25 ns |
| Temperature range | θ -40 - 80 °C |
| Protection rating | IP20 |
| Division unit TE (17.5 mm) | 4 |
| Connection cross-section, rigid | 2.5 - 35 mm ² |
| Connection cross-section, multi-wire | 2.5 - 35 mm ² |
| Connection cross-section, flexible | 2.5 - 35 mm ² |

Connection options

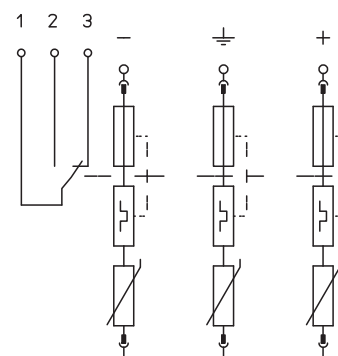



PV complete block 1,000 V DC

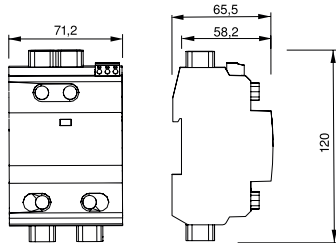

Type 1+2 combination arrester according to EN 50539-11 for lightning and surge protection of PV systems.

- Lightning protection equipotential bonding according to IEC 62305 (VDE 0185-305)
- Surge protection according to IEC 60364-7-712 (VDE 0100-712)
- Arresting capacity to 12.5 kA (10/350) and 40 kA (8/20)
- Error-resistant Y circuit with status display
- The FS variant possesses a potential-free changeover contact for remote signalling

Application: Lightning current and surge protective devices for PV systems.

| Type | U max DC V | Version | Pack Piece | Weight kg/100 pc. | Item no. |
|----------------|------------|-----------------|------------|-------------------|----------|
| V-PV-T1+2-1000 | 1000 | Y configuration | 1 | 40.700 | 5094230 |

Connection options

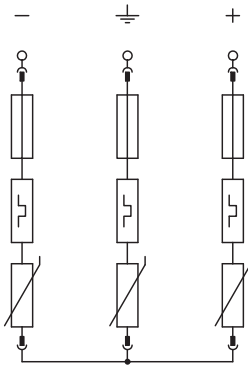

| V-PV-T1+2-1000 | | |
|--------------------------------------|-------------------|--------------------------|
| U max DC | U _c DC | 1000 V |
| SPD to EN 61643-11 | | Type 1+2 |
| Lightning protection zone LPZ | | 0→2 |
| Impulse discharge current (10/350) | I _{imp} | 6.25 kA |
| Nominal discharge current (8/20) | I _n | 20 kA |
| Maximum discharge current (8/20 μs) | I _{max} | 40 kA |
| Protection level | U _p | < 3,3 kV |
| Response time | t _A | < 25 ns |
| Temperature range | θ | -40 - 80 °C |
| Protection rating | | IP20 |
| Division unit TE (17.5 mm) | | 4 |
| Connection cross-section, rigid | | 2.5 - 35 mm ² |
| Connection cross-section, multi-wire | | 2.5 - 35 mm ² |
| Connection cross-section, flexible | | 2.5 - 35 mm ² |



PV complete block 1,000 V DC with remote signalling

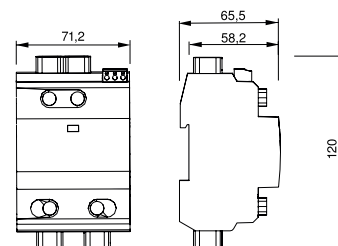

| Type | U max DC V | Version | Pack Piece | Weight kg/100 pc. | Item no. |
|------------------|------------|----------------------|------------|-------------------|----------|
| V-PV-T1+2-1000FS | 1000 | Y configuration + RS | 1 | 41.200 | 5094232 |

Type 1+2 combination arrester according to EN 50539-11 for lightning and surge protection of PV systems.

- Lightning protection equipotential bonding according to IEC 62305 (VDE 0185-305)
- Surge protection according to IEC 60364-7-712 (VDE 0100-712)
- Arresting capacity to 12.5 kA (10/350) and 40 kA (8/20)
- Error-resistant Y circuit with status display
- The FS variant possesses a potential-free changeover contact for remote signalling

Application: Lightning current and surge protective devices for PV systems.

| V-Type | | V-PV-T1+2-1000FS | |
|--------------------------------------|-------------------|--------------------------|--|
| U max DC | U _c DC | 1000 V | |
| SPD to EN 61643-11 | | Type 1+2 | |
| Lightning protection zone LPZ | | 0→2 | |
| Impulse discharge current (10/350) | I _{imp} | 6.25 kA | |
| Nominal discharge current (8/20) | I _n | 20 kA | |
| Maximum discharge current (8/20 μs) | I _{max} | 40 kA | |
| Protection level | U _p | < 3,3 kV | |
| Response time | t _A | < 25 ns | |
| Temperature range | θ | -40 - 80 °C | |
| Protection rating | | IP20 | |
| Division unit TE (17.5 mm) | | 4 | |
| Connection cross-section, rigid | | 2.5 - 35 mm ² | |
| Connection cross-section, multi-wire | | 2.5 - 35 mm ² | |
| Connection cross-section, flexible | | 2.5 - 35 mm ² | |

Connection options

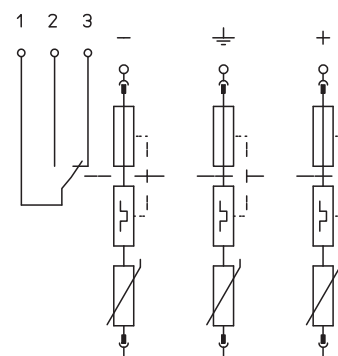



PV combination arrester V25, 900 V DC

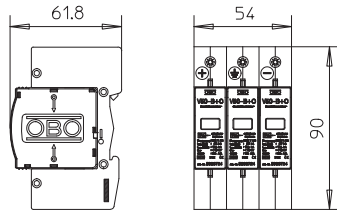

V25 combination arrester, type 1+2, for photovoltaic systems

- Complete unit, consisting of plug-in varistor arrester with cut-off unit
- Error-resistant Y circuit to VDE 0100-712 (EN 50539-12)
- Surge protection equipotential bonding to VDE 0100-443 (IEC 60364-4-44)
- Arresting capacity up to 7 kA (10/350) and 50 kA (8/20) per pole
- Low DC protection level: < 3.0 kV and Voc max = 900 V DC
- With visual function display for use in distributor housings

Application: PV systems with lightning protection system

| Type | U max DC V | Version | Pack Piece | Weight kg/100 pc. | Item no. |
|-----------------|------------|-----------------------|------------|-------------------|----------|
| V25-B+C 3-PH900 | 900 | 3-pole for PV systems | 1 | 42.200 | 5097447 |

Connection options

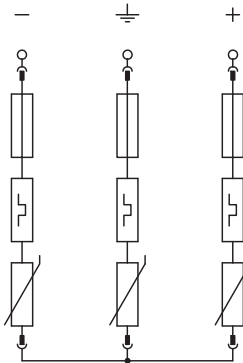

| V25-B+C 3-PH900 | |
|--------------------------------------|--------------------------|
| U max DC | U _c DC 900 V |
| SPD to EN 61643-11 | Type 1+2 |
| Lightning protection zone LPZ | 0→2 |
| Impulse discharge current (10/350) | I _{imp} 7 kA |
| Nominal discharge current (8/20) | I _n 30 kA |
| Maximum discharge current (8/20 μs) | I _{max} 50 kA |
| Protection level | U _p < 3,0 kV |
| Response time | t _A < 25 ns |
| Temperature range | ϑ -40 - +80 °C |
| Protection rating | IP 20 |
| Division unit TE (17.5 mm) | 3 |
| Connection cross-section, rigid | 2.5 - 35 mm ² |
| Connection cross-section, multi-wire | 2.5 - 35 mm ² |
| Connection cross-section, flexible | 2.5 - 25 mm ² |

PV combination arrester V25, 900 V DC with remote signalling

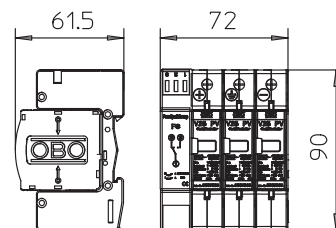

| Type | U max DC V | Version | Pack Piece | Weight kg/100 pc. | Item no. |
|------------------|------------|-------------------------------|------------|-------------------|----------|
| V25-B+C 3PHFS900 | 900 | 3 pole for PV systems with RS | 1 | 53.500 | 5097448 |

V25 combination arrester, type 1+2, for PV systems with FS contact as potential-free changeover

- Complete unit, consisting of plug-in varistor arrester with cut-off unit
- Error-resistant Y circuit for use according to VDE 0100-712 (EN 50539-12)
- Surge protection equipotential bonding to VDE 0100-443 (IEC 60364-4-44)
- Arresting capacity to 7 kA (10/350) and 50 kA (8/20) per pole
- Low DC protection level: < 3.0 kV and Voc max. = 900 V DC
- With visual display for use in distributor housings

Application: PV systems with lightning protection system

V25-B+C 3PHFS900

| | | |
|--------------------------------------|-------------------|--------------------------|
| U max DC | U _c DC | 900 V |
| SPD to EN 61643-11 | | Type 1+2 |
| Lightning protection zone LPZ | | 0→2 |
| Impulse discharge current (10/350) | I _{imp} | 7 kA |
| Nominal discharge current (8/20) | I _n | 30 kA |
| Maximum discharge current (8/20 μs) | I _{max} | 50 kA |
| Protection level | U _p | < 3,0 kV |
| Response time | t _A | < 25 ns |
| Temperature range | θ | -40 - +80 °C |
| Protection rating | | IP 20 |
| Division unit TE (17.5 mm) | | 4 |
| Connection cross-section, rigid | | 2.5 - 35 mm ² |
| Connection cross-section, multi-wire | | 2.5 - 35 mm ² |
| Connection cross-section, flexible | | 2.5 - 25 mm ² |

Connection options

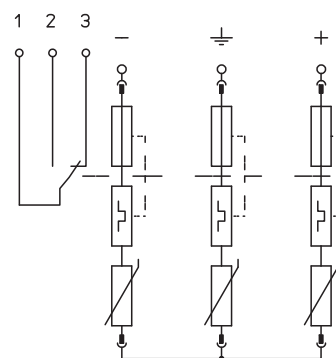



PV combination arrester V50, 600 V DC

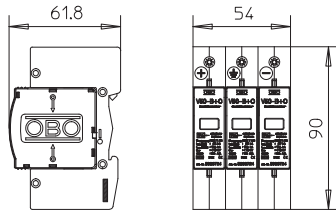

V50 combination arrester, type 1+2, for photovoltaic systems

- Complete unit, consisting of plug-in varistor arrester with cut-off unit
- Error-resistant Y circuit to VDE 0100-712 (EN 50539-12)
- Surge protection equipotential bonding to VDE 0100-443 (IEC 60364-4-44)
- Arresting capacity up to 12.5 kA (10/350) and 50 kA (8/20) per pole
- Low DC protection level: < 2.6 kV and $V_{oc\ max} = 600\ V\ DC$
- With visual function display for use in distributor housings

Application: PV systems with lightning protection system

| Type | U max DC V | Version | Pack Piece | Weight kg/100 pc. | Item no. |
|-----------------|------------|-----------------------|------------|-------------------|----------|
| V50-B+C 3-PH600 | 600 | 3-pole for PV systems | 1 | 41.000 | 5093623 |

Connection options

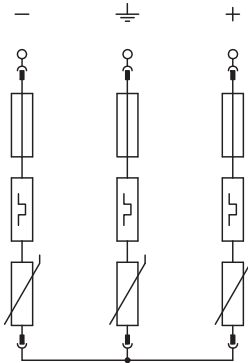

V50-B+C 3-PH600

| | | |
|--------------------------------------|-------------------|--------------------------|
| U max DC | U _c DC | 600 V |
| SPD to EN 61643-11 | | Type 1+2 |
| Lightning protection zone LPZ | | 0-2 |
| Impulse discharge current (10/350) | I _{imp} | 12.5 kA |
| Nominal discharge current (8/20) | I _n | 30 kA |
| Maximum discharge current (8/20 μs) | I _{max} | 50 kA |
| Protection level | U _p | < 2,6 kV |
| Response time | t _A | < 25 ns |
| Temperature range | θ | -40 - +80 °C |
| Protection rating | | IP 20 |
| Division unit TE (17.5 mm) | | 3 |
| Connection cross-section, rigid | | 2.5 - 35 mm ² |
| Connection cross-section, multi-wire | | 2.5 - 35 mm ² |
| Connection cross-section, flexible | | 2.5 - 25 mm ² |

PV combination arrester V50, 600 V DC with remote signalling

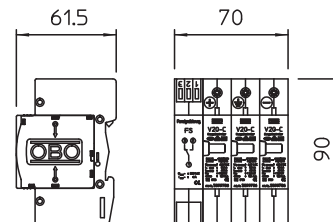

| Type | U max DC V | Version | Pack Piece | Weight kg/100 pc. | Item no. |
|------------------|------------|-------------------------------|------------|-------------------|----------|
| V50-B+C 3PHFS600 | 600 | 3-pole for PV systems with FS | 1 | 49.600 | 5093625 |

V50 combination arrester, type 1+2, for PV systems with FS contact as potential-free changeover

- Complete unit, consisting of plug-in varistor arrester with cut-off unit
- Error-resistant Y circuit for use according to VDE 0100-712 (EN 50539-12)
- Surge protection equipotential bonding to VDE 0100-443 (IEC 60364-4-44)
- Arresting capacity to 12.5 kA (10/350) and 50 kA (8/20) per pole
- Low DC voltage protection level: < 2.6 kV and Voc max. = 600 V DC
- With visual display for use in distributor housings

Application: PV systems with lightning protection system

| V50-B+C 3PHFS600 | |
|--------------------------------------|--------------------------|
| U max DC | U _c DC 600 V |
| SPD to EN 61643-11 | Type 1+2 |
| Lightning protection zone LPZ | 0→2 |
| Impulse discharge current (10/350) | I _{imp} 12.5 kA |
| Nominal discharge current (8/20) | I _n 30 kA |
| Maximum discharge current (8/20 μs) | I _{max} 50 kA |
| Protection level | U _p < 2,6 kV |
| Response time | t _A < 25 ns |
| Temperature range | ϑ -40 - +80 °C |
| Protection rating | IP 20 |
| Division unit TE (17.5 mm) | 4 |
| Connection cross-section, rigid | 2.5 - 35 mm ² |
| Connection cross-section, multi-wire | 2.5 - 35 mm ² |
| Connection cross-section, flexible | 2.5 - 25 mm ² |

Connection options

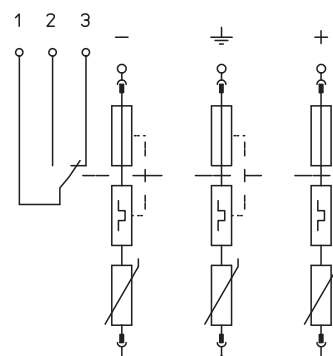



PV complete block 1500 V DC

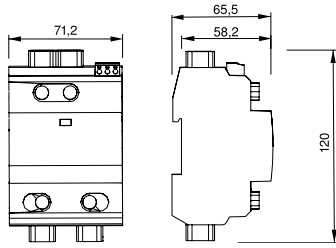

Type 2 surge protection for PV plants.

- Surge protection according to IEC 60364-7-712 (VDE 0100-712)
- Arresting capacity of 20 kA per pole and up to 40 kA (8/20)
- Error-resistant Y circuit with status display
- The FS variant possesses a potential-free changeover contact for remote signalling

Application: Surge protective devices for PV systems.

| Type | U max DC V | Version | Pack Piece | Weight kg/100 pc. | Item no. |
|--------------|------------|-----------------|------------|-------------------|----------|
| V-PV-T2-1500 | 1500 | Y configuration | 1 | 33.800 | 5094210 |

Connection options

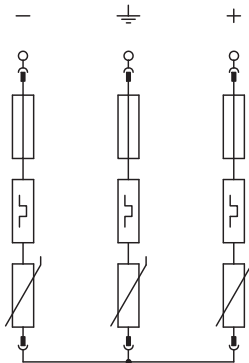

V-PV-T2-1500

| | | |
|--------------------------------------|-------------------|--------------------------|
| U max DC | U _e DC | 1500 V |
| SPD to EN 61643-11 | | Type 2 |
| Lightning protection zone LPZ | | 1→2 |
| Nominal discharge current (8/20) | I _n | 20 kA |
| Maximum discharge current (8/20 μs) | I _{max} | 40 kA |
| Protection level | U _o | < 4,5 kV |
| Response time | t _A | < 25 ns |
| Temperature range | θ | -40 - 80 °C |
| Protection rating | | IP20 |
| Division unit TE (17.5 mm) | | 4 |
| Connection cross-section, rigid | | 2.5 - 35 mm ² |
| Connection cross-section, multi-wire | | 2.5 - 35 mm ² |
| Connection cross-section, flexible | | 2.5 - 35 mm ² |

PV complete block 1500 V DC with remote signalling

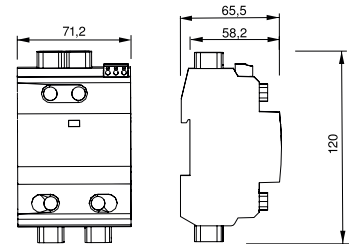

| Type | U max DC V | Version | Pack Piece | Weight kg/100 pc. | Item no. |
|-----------------|------------|----------------------|------------|-------------------|----------|
| V-PV-T2-1500+FS | 1500 | Y configuration + RS | 1 | 34.400 | 5094212 |

Type 2 surge protection for PV plants.

- Surge protection according to IEC 60364-7-712 (VDE 0100-712)
- Arresting capacity of 20 kA per pole and up to 40 kA (8/20)
- Error-resistant Y circuit with status display
- The FS variant possesses a potential-free changeover contact for remote signalling

Application: Surge protective devices for PV systems.

V-PV-T2-1500+FS

| | | |
|--------------------------------------|-------------------|--------------------------|
| U max DC | U _c DC | 1500 V |
| SPD to EN 61643-11 | | Type 2 |
| Lightning protection zone LPZ | | 1→2 |
| Nominal discharge current (8/20) | I _n | 20 kA |
| Maximum discharge current (8/20 μs) | I _{max} | 40 kA |
| Protection level | U _p | < 4,5 kV |
| Response time | t _A | < 25 ns |
| Temperature range | ϑ | -40 - 80 °C |
| Protection rating | | IP20 |
| Division unit TE (17.5 mm) | | 4 |
| Connection cross-section, rigid | | 2.5 - 35 mm ² |
| Connection cross-section, multi-wire | | 2.5 - 35 mm ² |
| Connection cross-section, flexible | | 2.5 - 35 mm ² |

Connection options

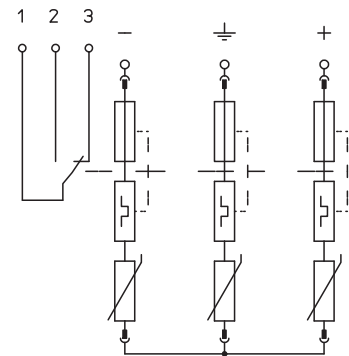



PV surge protection V20, 1000 V DC

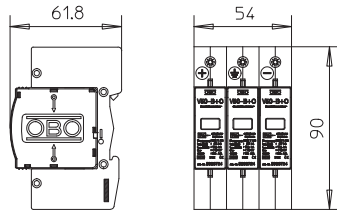

V20 surge arrester, type 2, for photovoltaic systems

- Complete unit, consisting of plug-in varistor arrester with cut-off unit
- Error-resistant Y circuit to VDE 0100-712 (EN 50539-12)
- Surge protection equipotential bonding to VDE 0100-443 (IEC 60364-4-44)
- V20-C 3-PH-1000 tested to EN 50539-11 (VDE / KEMA)
- Arresting capacity to 40 kA (8/20) per pole
- Low DC protection level: < 4.0 kV and Voc max = 1,000 V DC
- With visual status display for use in distributor housings

Application: PV systems with or without separate lightning protection system

| Type | U max DC V | Version | Pack Piece | Weight kg/100 pc. | Item no. |
|-----------------|------------|-----------------------|------------|-------------------|----------|
| V20-C 3-PH-1000 | 1000 | 3-pole for PV systems | 1 | 34.520 | 5094608 |

Connection options

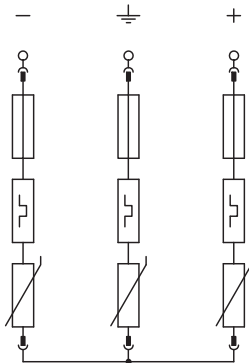

| V20-C 3-PH-1000 | |
|--------------------------------------|--------------------------|
| U max DC | U _c DC 1000 V |
| SPD to EN 61643-11 | Type 2 |
| Lightning protection zone LPZ | 1→2 |
| Nominal discharge current (8/20) | I _n 20 kA |
| Maximum discharge current (8/20 μs) | I _{max} 40 kA |
| Protection level | U _p < 4,0 kV |
| Response time | t _A < 25 ns |
| Temperature range | ϑ -40 - +80 °C |
| Protection rating | IP 20 |
| Division unit TE (17.5 mm) | 3 |
| Connection cross-section, rigid | 2.5 - 35 mm ² |
| Connection cross-section, multi-wire | 2.5 - 35 mm ² |
| Connection cross-section, flexible | 2.5 - 25 mm ² |



PV surge protection V20, 1000 V DC with remote signalling

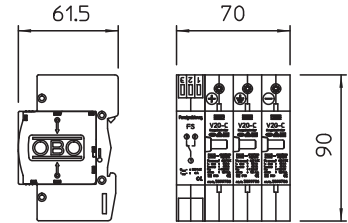

| Type | U max DC V | Version | Pack Piece | Weight kg/100 pc. | Item no. |
|------------------|------------|-------------------------------|------------|-------------------|----------|
| V20-C 3PHFS-1000 | 1000 | 3-pole for PV systems with FS | 1 | 44.500 | 5094574 |

V20 surge arrester, type 2, for photovoltaic systems

- Complete unit, consisting of plug-in varistor arrester with cut-off unit
- Error-resistant Y circuit to VDE 0100-712 (EN 50539-12)
- Surge protection equipotential bonding to VDE 0100-443 (IEC 60364-4-44)
- V20-C 3-PH-1000 tested to EN 50539-11 (VDE / KEMA)
- Arresting capacity to 40 kA (8/20) per pole
- Low DC protection level: < 4.0 kV and Voc max = 1,000 V DC
- With visual status display for use in distributor housings

Application: PV systems with or without separate lightning protection system

| V20-C 3PHFS-1000 | |
|--------------------------------------|--------------------------|
| U max DC | U _c DC 1000 V |
| SPD to EN 61643-11 | Type 2 |
| Lightning protection zone LPZ | 1→2 |
| Nominal discharge current (8/20) | I _n 20 kA |
| Maximum discharge current (8/20 μs) | I _{max} 40 kA |
| Protection level | U _p < 4,0 kV |
| Response time | t _A < 25 ns |
| Temperature range | ϑ -40 - +80 °C |
| Protection rating | IP 20 |
| Division unit TE (17.5 mm) | 4 |
| Connection cross-section, rigid | 2.5 - 35 mm ² |
| Connection cross-section, multi-wire | 2.5 - 35 mm ² |
| Connection cross-section, flexible | 2.5 - 25 mm ² |

Connection options

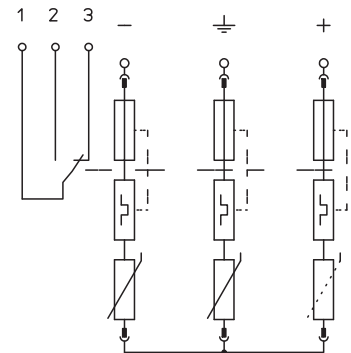



PV surge protection V20, 600 V DC

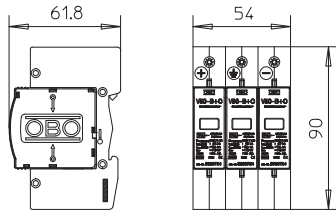

V20 surge arrester, type 2, for PV systems

- Complete unit, consisting of plug-in varistor arrester with cut-off unit
- Error-resistant Y circuit for use according to VDE 0100-712 (EN 50539-12)
- For surge protection equipotential bonding to VDE 0100-443 (IEC 60364-4-44)
- Arresting capacity to 40 kA (8/20) per pole
- Low DC protection level: < 2.6 kV (U_{oc} max = 600 V DC)
- Arrester, connectable with thermodynamic cut-off unit and visual function display
- Encapsulated, zinc oxide varistor arrester for use in distributor housings

Application: PV systems with or without separate lightning protection system

| Type | U max DC V | Version | Pack Piece | Weight kg/100 pc. | Item no. |
|---------------|------------|-----------------------|------------|-------------------|----------|
| V20-C 3PH-600 | 600 | 3-pole for PV systems | 1 | 33.500 | 5094605 |

Connection options

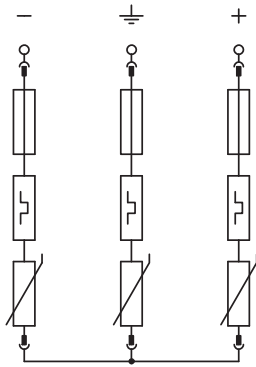

| V20-C 3PH-600 | |
|--------------------------------------|--------------------------|
| U max DC | U _c DC 600 V |
| SPD to EN 61643-11 | Type 2 |
| Lightning protection zone LPZ | 1→2 |
| Nominal discharge current (8/20) | I _n 20 kA |
| Maximum discharge current (8/20 μs) | I _{max} 40 kA |
| Protection level | U _p < 2,6 kV |
| Response time | t _A < 25 ns |
| Temperature range | θ -40 - +80 °C |
| Protection rating | IP 20 |
| Division unit TE (17.5 mm) | 3 |
| Connection cross-section, rigid | 2.5 - 35 mm ² |
| Connection cross-section, multi-wire | 2.5 - 35 mm ² |
| Connection cross-section, flexible | 2.5 - 25 mm ² |



PV surge protection V20, 600 V DC with remote signalling

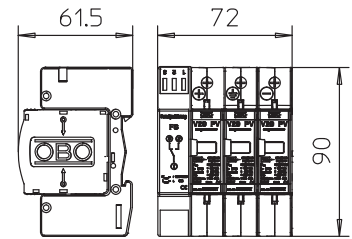

| Type | U max DC V | Version | Pack Piece | Weight kg/100 pc. | Item no. |
|-----------------|------------|--|------------|-------------------|----------|
| V20-C 3PHFS-600 | 600 | 3-pole for PV systems; Y circuit with FS | 1 | 41.500 | 5094576 |

V20 surge arrester, type 2, for PV systems with FS contact as potential-free changeover

- Complete unit, consisting of plug-in varistor arrester with cut-off unit
- Error-resistant Y circuit for use according to VDE 0100-712 (EN 50539-12)
- For surge protection equipotential bonding to VDE 0100-443 (IEC 60364-4-44)
- Arresting capacity to 40 kA (8/20) per pole
- Low DC protection level: < 2.6 kV (Voc max = 600 V DC)
- Arrester, connectable with thermodynamic cut-off unit and visual function display
- Encapsulated, zinc oxide varistor arrester for use in distributor housings

Application: PV systems with or without separate lightning protection system

| V20-C 3PHFS-600 | |
|--------------------------------------|--------------------------|
| U max DC | U _c DC 600 V |
| SPD to EN 61643-11 | Type 2 |
| Lightning protection zone LPZ | 1→2 |
| Nominal discharge current (8/20) | I _n 20 kA |
| Maximum discharge current (8/20 μs) | I _{max} 40 kA |
| Protection level | U _p < 2,6 kV |
| Response time | t _A < 25 ns |
| Temperature range | θ -40 - +80 °C |
| Protection rating | IP 20 |
| Division unit TE (17.5 mm) | 4 |
| Connection cross-section, rigid | 2.5 - 35 mm ² |
| Connection cross-section, multi-wire | 2.5 - 35 mm ² |
| Connection cross-section, flexible | 2.5 - 25 mm ² |

Connection options

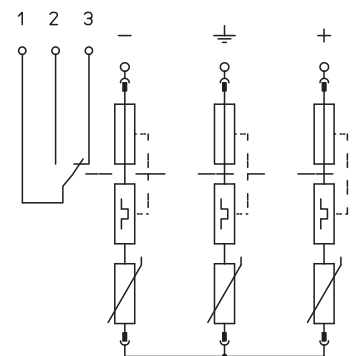



PV system solution, type 1+2, for inverter with 1 MPP tracker, 900 V DC

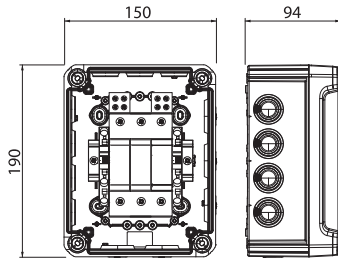

System solution for photovoltaic inverter with 1 separate MPP tracker

- Varistor arrester, connectable with cut-off unit in error-resistant Y circuit to VDE 0100-712 (50539-12)
- For each protection device, there are 3 terminal points up to 16 mm² pre-mounted in the housing, up to 30 A DC per terminal
- Low DC protection level: < 3.0 kV (U_{oc} max = 900 V DC with V25-B+C/0-450PV)
- Pre-mounted in polycarbonate housing (IP66), UV-resistant for the use outside, including cable gland kit

For DC protection of the inverter in photovoltaic systems. If there is a danger of condensation forming through wind, ice, temperature or sunlight, further measures may be necessary!

| Type | U max DC V | Version | Pack Piece | Weight kg/100 pc. | Item no. |
|------------------|------------|------------------------------------|------------|-------------------|----------|
| VG-V25-BC3-PH900 | 900 | Type 1+2 in housing with terminals | 1 | 93.000 | 5088591 |

Connection options

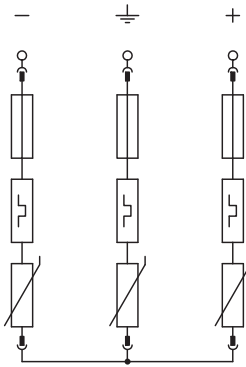

| VG-V25-BC3-PH900 | |
|-------------------------------------|--------------------------|
| U max DC | U _c DC 900 V |
| SPD to EN 61643-11 | Type 1+2 |
| Lightning protection zone LPZ | 0→2 |
| Impulse discharge current (10/350) | I _{imp} 7 kA |
| Nominal discharge current (8/20) | I _n 30 kA |
| Maximum discharge current (8/20 μs) | I _{max} 50 kA |
| Protection level | U _p < 3,0 kV |
| Response time | t _A < 25 ns |
| Connection cross-section, rigid | 1.5 - 16 mm ² |
| Connection cross-section, flexible | 1.5 - 10 mm ² |
| Temperature range | ϑ -40 - +80 °C |
| Protection rating | IP66 |



PV system solution, type 2, for inverter with 1 MPP tracker, 1,000 V DC

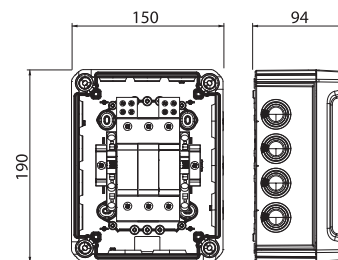

| Type | U max DC V | Version | Pack Piece | Weight kg/100 pc. | Item no. |
|------------------|------------|----------------------------------|------------|-------------------|----------|
| VG-V20-C3-PH1000 | 1000 | Type 2 in housing with terminals | 1 | 87.000 | 5088593 |

System solution for photovoltaic inverter with 1 separate MPP tracker

- Varistor arrester, connectable with cut-off unit in error-resistant Y circuit to VDE 0100-712 (50539-12)
- For each protection device, there are 3 terminal points up to 16 mm² pre-mounted in the housing, up to 30 A DC per terminal
- Low DC protection level: < 4.0 kV (Uoc max = 1,000 V DC with V20-B/0-500PV)
- Pre-mounted in polycarbonate housing (IP66), UV-resistant for the use outside, including cable gland kit

For DC protection of the inverter in photovoltaic systems. If there is a danger of condensation forming through wind, ice, temperature or sunlight, further measures may be necessary!

| VG-V20-C3-PH1000 | |
|-------------------------------------|--------------------------|
| U max DC | U _c DC 1000 V |
| SPD to EN 61643-11 | Type 2 |
| Lightning protection zone LPZ | 1→2 |
| Nominal discharge current (8/20) | I _n 20 kA |
| Maximum discharge current (8/20 μs) | I _{max} 40 kA |
| Protection level | U _p < 4,0 kV |
| Response time | t _A < 25 ns |
| Connection cross-section, rigid | 1.5 - 16 mm ² |
| Connection cross-section, flexible | 1.5 - 10 mm ² |
| Temperature range | ϑ -40 - +80 °C |
| Protection rating | IP66 |

Connection options

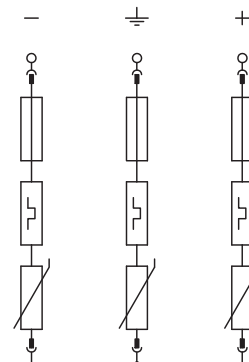



PV system solution, type 1+2, for inverter with 2 MPP trackers, 900 V DC

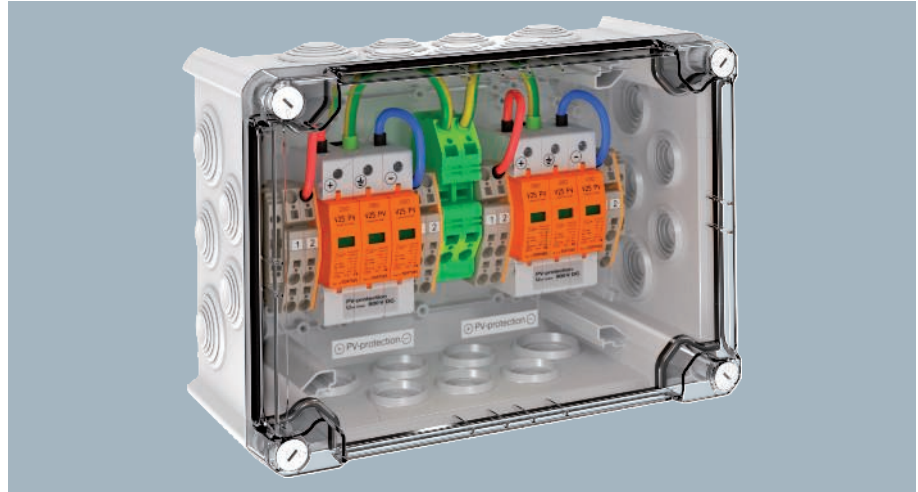
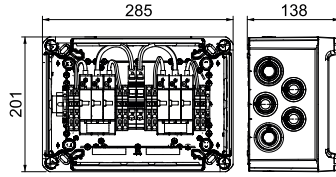

System solution for photovoltaic inverter with 2 separate MPP trackers

- Varistor arrester, connectable with disconnecting device in error-resistant Y circuit to VDE 0100-712 (50539-12)
- Low DC protection level: < 4.0 kV (Uoc max = 1,000 V DC with V20-C/0-500PV)
- Low DC protection level: < 3.0 kV (Uoc max = 900 V DC with V25-B+C/0-450PV)
- Per protection device, there are 4 terminals up to 6 mm² pre-mounted in the housing, up to 30 A DC per terminal
- Pre-mounted in polycarbonate housing (IP66), UV-resistant for the use outside, including cable gland kit

For DC protection of the inverter in photovoltaic systems. If there is a danger of condensation forming through wind, ice, temperature or sunlight, further measures may be necessary!

| Type | U max DC V | Version | Pack Piece | Weight kg/100 pc. | Item no. |
|-----------------------|------------|--|------------|-------------------|----------------|
| VG-BCPV900K 22 | 900 | For two MPP and with terminal connection | 1 | 220.000 | 5088566 |

Connection options

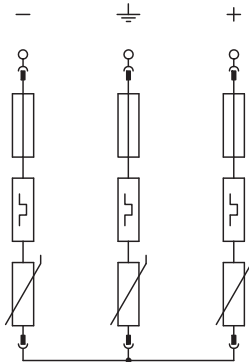

| VG-BCPV900K 22 | |
|-------------------------------------|-------------------------|
| U max DC | U _c DC 900 V |
| SPD to EN 61643-11 | Type 1+2 |
| Lightning protection zone LPZ | 0→2 |
| Nominal discharge current (8/20) | I _n 30 kA |
| Maximum discharge current (8/20 μs) | I _{max} 60 kA |
| Protection level | U _p < 3,0 kV |
| Response time | t _A < 25 ns |
| Temperature range | θ -30 - 90 °C |
| Protection rating | IP66 |



PV system solution, type 2, for inverter with 2 MPP trackers, 1,000 V DC

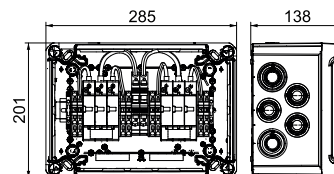

| Type | U max DC V | Version | Pack Piece | Weight kg/100 pc. | Item no. |
|----------------|------------|--|------------|-------------------|----------|
| VG-CPV1000K 22 | 1000 | For two MPP and with terminal connection | 1 | 216.600 | 5088568 |

System solution for photovoltaic inverter with 2 separate MPP trackers

- Varistor arrester, connectable with cut-off unit in error-resistant Y circuit to VDE 0100-712 (50539-12)
- Low DC protection level: < 4,0 kV (Voc max = 1,000 V DC with V20-B+C/0-500PV)
- Per protection device, there are 4 terminals up to 6 mm² pre-mounted in the housing, up to 30 A DC per terminal
- Pre-mounted in polycarbonate housing (IP66), UV-resistant for use outside, including cable gland kit

For DC protection of the inverter in photovoltaic systems. If there is a danger of condensation forming through wind, ice, temperature or sunlight, further measures may be necessary!

VG-CPV1000K 22

| | | |
|-------------------------------------|-------------------|--------------|
| U max DC | U _c DC | 1000 V |
| SPD to EN 61643-11 | | Type 2 |
| Lightning protection zone LPZ | | 1→2 |
| Nominal discharge current (8/20) | I _n | 20 kA |
| Maximum discharge current (8/20 μs) | I _{max} | 40 kA |
| Protection level | U _p | < 4,0 kV |
| Response time | t _A | < 25 ns |
| Temperature range | θ | -40 - +80 °C |
| Protection rating | | IP66 |

Connection options

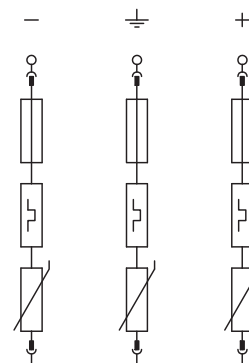



PV system solution, type 1+2, for inverter with 3 MPP trackers, 900 V DC

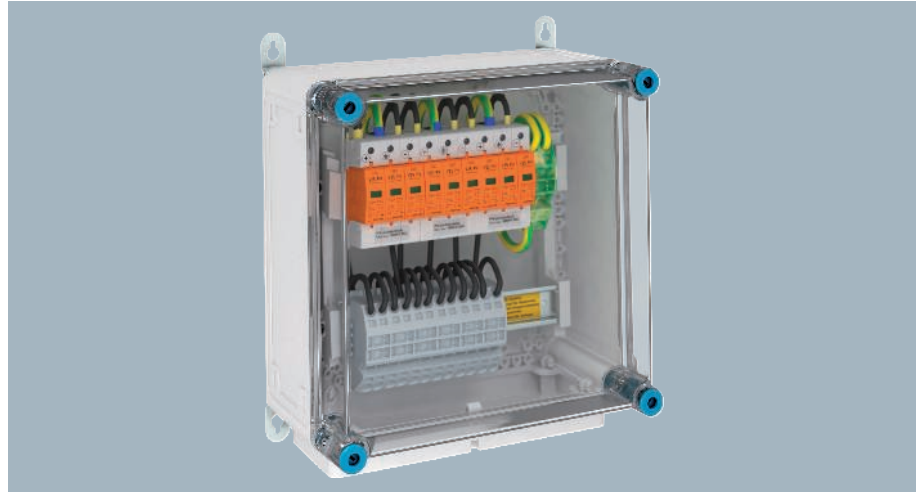
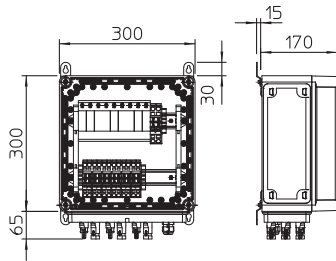

System solution for photovoltaic inverter with 3 separate MPP trackers

- Varistor arrester, connectable with cut-off unit in error-resistant Y circuit to VDE 0100-712 (50539-12)
- Low DC protection level: < 3.0 kV (Voc max = 900 V DC with V25-B+C/0-450PV)
- Per protection device there are 6 terminals up to 6 mm² pre-mounted in the housing, up to 30 A DC per terminal
- Pre-mounted in polycarbonate housing (IP65), UV-resistant for use outside, including cable gland kit

For DC protection of the inverter in photovoltaic systems. If there is a danger of condensation forming through wind, ice, temperature or sunlight, further measures may be necessary!

| Type | U max DC V | Version | Pack Piece | Weight kg/100 pc. | Item no. |
|-------------------------|------------|--|------------|-------------------|----------------|
| VG-BCPV 900K 333 | 900 | For three MPP and with terminal connection | 1 | 546.000 | 5088579 |

Connection options

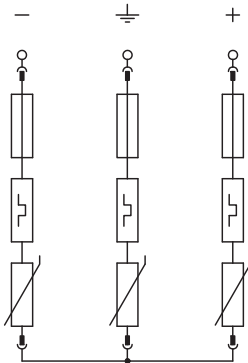

VG-BCPV 900K 333

| | | |
|-------------------------------------|-------------------|--------------|
| U max DC | U _c DC | 900 V |
| SPD to EN 61643-11 | | Type 1+2 |
| Lightning protection zone LPZ | | 0-2 |
| Impulse discharge current (10/350) | I _{imp} | 7 kA |
| Nominal discharge current (8/20) | I _n | 30 kA |
| Maximum discharge current (8/20 μs) | I _{max} | 60 kA |
| Protection level | U _o | < 3,0 kV |
| Response time | t _A | < 25 ns |
| Temperature range | θ | -40 - +80 °C |
| Protection rating | | IP65 |



PV system solution, type 2, for inverter with 3 MPP trackers, 1,000 V DC

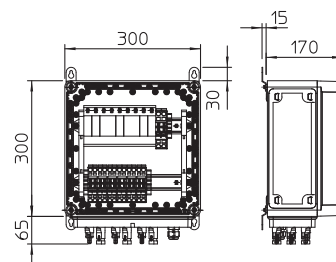
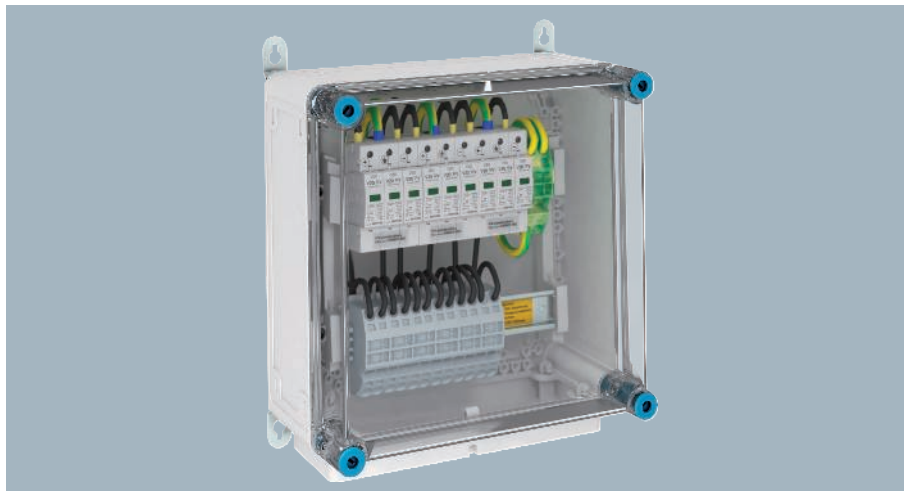

| Type | U max DC V | Version | Pack Piece | Weight kg/100 pc. | Item no. |
|------------------|------------|--|------------|-------------------|----------|
| VG-CPV 1000K 333 | 1000 | For three MPP and with terminal connection | 1 | 528.000 | 5088585 |

System solution for photovoltaic inverter with 3 separate MPP trackers

- Varistor arrester, connectable with cut-off unit in error-resistant Y circuit to VDE 0100-712 (50539-12)
- Low DC protection level: < 4.0 kV (Voc max = 1,000 V DC with V20-B+C/0-500PV)
- Per protection device, there are 6 terminals up to 6 mm² pre-mounted in the housing, up to 30 A DC per terminal
- Pre-mounted in polycarbonate housing (IP65), UV-resistant for use outside, including cable gland kit

For DC protection of the inverter in photovoltaic systems. If there is a danger of condensation forming through wind, ice, temperature or sunlight, further measures may be necessary!

VG-CPV 1000K 333

| | | |
|-------------------------------------|-------------------|--------------|
| U max DC | U _c DC | 1000 V |
| SPD to EN 61643-11 | | Type 2 |
| Lightning protection zone LPZ | | 1→2 |
| Nominal discharge current (8/20) | I _n | 20 kA |
| Maximum discharge current (8/20 μs) | I _{max} | 40 kA |
| Protection level | U _p | < 4,0 kV |
| Response time | t _A | < 25 ns |
| Temperature range | θ | -40 - +80 °C |
| Protection rating | | IP65 |

Connection options

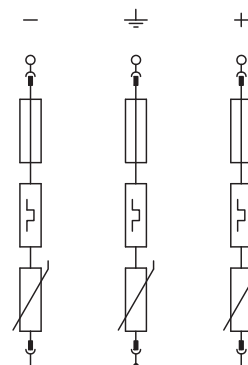



Photovoltaic housing with connection terminals, unequipped

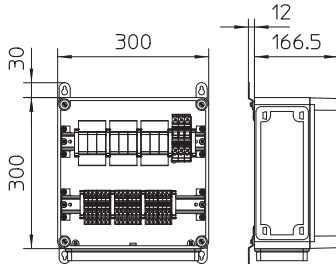

System solution for photovoltaic inverter with 3 separate MPP trackers, unequipped

- Varistor arrester, connectable with cut-off unit in error-resistant Y circuit to VDE 0100-712 (50539-12)
- 5088609: Two PV string inputs (MC4 plug connector) at an MPP inverter input, IN up to 15 A DC per MC4 connector
- 5088573: Per protection device there are 6 terminals up to 6 mm² pre-mounted in the housing, IN up to 30 A DC per terminal
- Unequipped, order upper parts separately
- Pre-mounted in polycarbonate housing (IP65), UV-resistant for use outside, including cable gland kit

For DC protection of the inverter in photovoltaic systems. If there is a danger of condensation forming through wind, ice, temperature or sunlight, further measures may be necessary!

| Type | U max DC V | Version | Pack Piece | Weight kg/100 pc. | Item no. |
|------------------------|------------|------------------------|------------|-------------------|----------------|
| VG-BCPV U K 333 | 1000 | For 3 MPPs, unequipped | 1 | 478.000 | 5088573 |

Connection options

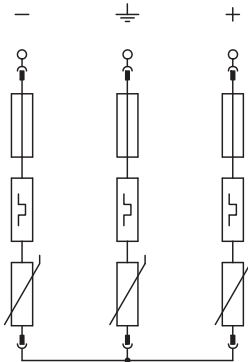

VG-BCPV U K 333

| | | |
|------------------------------------|-------------------|--------------------------|
| U max DC | U _c DC | 1000 V |
| Connection cross-section, rigid | | 0.5 - 10 mm ² |
| Connection cross-section, flexible | | 0.5 - 6 mm ² |
| Temperature range | ∅ | -40 - +80 °C |
| Protection rating | | IP65 |

Photovoltaic housing with 4 fuse holders, V25, 900 V

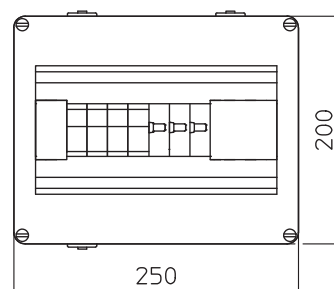

| Type | U max DC V | Version | Pack Piece | Weight kg/100 pc. | Item no. |
|----------------|------------|---|------------|-------------------|----------|
| VG-BC PV900KS4 | 900 | Type 1+2 in housing with fuse holder (unequipped) | 1 | 205.000 | 5088640 |

System solution for photovoltaic fuses (unequipped) for photovoltaic inverters with 1 MPP tracker

- Error-resistant Y circuit to VDE 0100-712 (50539-12)
- Low DC protection level: < 3.0 kV (Voc max = 900 V DC with V25-B+C/0-450PV)
- (+) poles protected via 4 photovoltaic fuses 10 x 38 mm (unequipped), 900 V DC protected
- 4 (-) poles via terminal up to 6 mm² switched in parallel in the housing, up to 30 A DC per terminal
- Pre-mounted in polycarbonate housing (IP65), UV-resistant for use outside, including cable gland kit

For DC protection of the inverter in photovoltaic systems. If there is a danger of condensation forming through wind, ice, temperature or sunlight, further measures may be necessary!

VG-BC PV900KS4

| | | |
|-------------------------------------|-------------------|-------------------------|
| U max DC | U _c DC | 900 V |
| SPD to EN 61643-11 | | Type 1+2 |
| Lightning protection zone LPZ | | 1→2 |
| Impulse discharge current (10/350) | I _{imp} | 7 kA |
| Nominal discharge current (8/20) | I _n | 30 kA |
| Maximum discharge current (8/20 μs) | I _{max} | 60 kA |
| Protection level | U _p | < 3,0 kV |
| Response time | t _A | < 25 ns |
| Connection cross-section, rigid | | 0.5 - 6 mm ² |
| Connection cross-section, flexible | | 0.5 - 6 mm ² |
| Temperature range | θ | -40 - +80 °C |
| Protection rating | | IP 65 |

Connection options

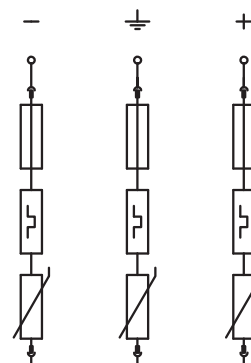



Photovoltaic housing with 4 fuses 10 A

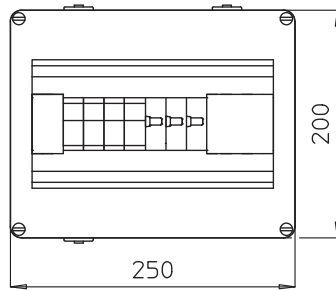

System solution for photovoltaic fuses for photovoltaic inverters with 1 MPP tracker

- Error-resistant Y circuit to VDE 0100-712 (50539-12)
- Low DC protection level: < 4.0 kV ($V_{oc\ max} = 1,000\ V\ DC\ with\ V20-C/0-500PV$)
- (+) poles protected via 4 photovoltaic fuses 10x38 mm 10 A, 1,000 V DC protected
- 4 (-) poles via terminal up to 6 mm² switched in parallel in the housing, up to 30 A DC per terminal
- Pre-mounted in polycarbonate housing (IP65), UV-resistant for use outside, including cable gland kit

For DC protection of the inverter in photovoltaic systems.
If there is a danger of condensation forming through wind, ice, temperature or sunlight, further measures may be necessary!

| Type | U max DC V | Version | Pack Piece | Weight kg/100 pc. | Item no. |
|-------------------------|------------|--|------------|-------------------|----------------|
| VG-C DCPH1000-4S | 1000 | Type 2 in housing with 4 PV fuses (10 A) | 1 | 200.000 | 5088651 |

Connection options

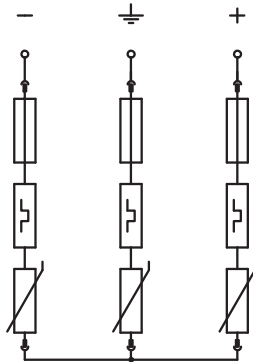

VG-C DCPH1000-4S

| | | |
|-------------------------------------|-------------------|-------------------------|
| U max DC | U _c DC | 1000 V |
| SPD to EN 61643-11 | | Type 2 |
| Lightning protection zone LPZ | | 1→2 |
| Nominal discharge current (8/20) | I _n | 20 kA |
| Maximum discharge current (8/20 μs) | I _{max} | 40 kA |
| Protection level | U _b | < 4,0 kV |
| Response time | t _A | < 25 ns |
| Connection cross-section, rigid | | 0.5 - 6 mm ² |
| Connection cross-section, flexible | | 0.5 - 6 mm ² |
| Temperature range | ϑ | -40 - +80 °C |
| Protection rating | | IP 65 |



Photovoltaic housing with 4 fuse holders, un-equipped

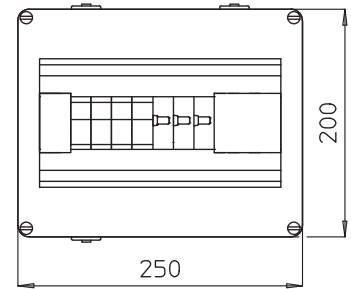

| Type | U max DC V | Version | Pack Piece | Weight kg/100 pc. | Item no. |
|----------------|------------|---|------------|-------------------|----------|
| VG-C PV1000KS4 | 1000 | Type 2 in housing with fuse holder (unequipped) | 1 | 190.000 | 5088654 |

System solution for photovoltaic fuses for photovoltaic inverters with 1 MPP tracker

- Error-resistant Y circuit to VDE 0100-712 (50539-12)
- Low DC protection level: < 4.0 kV (Voc max = 1,000 V DC with V20-C/0-500PV)
- Item no.: 5088654: (+) poles protected via 4 photovoltaic fuses 10 x 38 mm (unequipped), 1,000 V DC protected
- Item no.: 5088640: (+) poles protected via 4 photovoltaic fuses 10 x 38 mm (unequipped), 900 V DC protected
- 4 (-) poles via terminal up to 6 mm² switched in parallel in the housing, up to 30 A DC per terminal
- Pre-mounted in polycarbonate housing (IP65), UV-resistant for use outside, including cable gland kit

For DC protection of the inverter in photovoltaic systems. If there is a danger of condensation forming through wind, ice, temperature or sunlight, further measures may be necessary!

| VG-C PV1000KS4 | |
|-------------------------------------|--------------------------|
| U max DC | U _c DC 1000 V |
| SPD to EN 61643-11 | Type 2 |
| Lightning protection zone LPZ | 1→2 |
| Nominal discharge current (8/20) | I _n 20 kA |
| Maximum discharge current (8/20 μs) | I _{max} 40 kA |
| Protection level | U _p < 4,0 kV |
| Response time | t _A < 25 ns |
| Connection cross-section, rigid | 0.5 - 6 mm ² |
| Connection cross-section, flexible | 0.5 - 6 mm ² |
| Temperature range | ϑ -40 - +80 °C |
| Protection rating | IP 65 |

Connection options

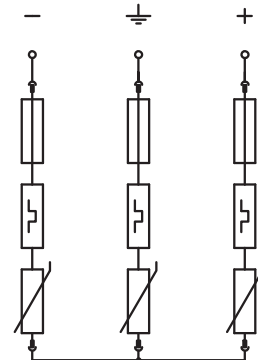



PV system solution, type 1+2, to 900 V DC with switch disconnecter (32 A)

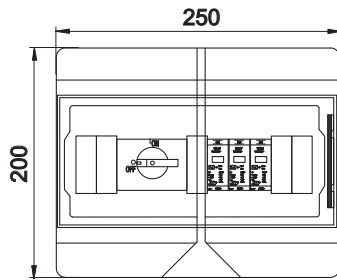

- System solution for circuit breaker photovoltaic inverter with 1 MPP tracker
- Varistor arrester, connectable with cut-off unit in error-resistant Y circuit to VDE 0100-712 (50539-12)
 - Low DC protection level: < 3.0 kV (Voc max = 900 V DC with V25-B+C/0-450PV)
 - Circuit breaker (1,000 V; 32 A) for secure switch-off of the DC string cable
 - Per protection device there is 1 terminal up to 6 mm² pre-mounted in the housing, up to 30 A DC per terminal
 - Pre-mounted in polycarbonate housing (IP65), UV-resistant for use outside, including cable gland kit

For DC protection of the inverter in photovoltaic systems.
If there is a danger of condensation forming through wind, ice, temperature or sunlight, further measures may be necessary!

| Type | U max DC V | Version | Pack Piece | Weight kg/100 pc. | Item no. |
|-----------------------|------------|---|------------|-------------------|----------------|
| VG-BC DC-TS900 | 900 | Type 1+2 and Benedikt LS32-SMA-A4 DC isolator | 1 | 182.500 | 5088635 |

Connection options

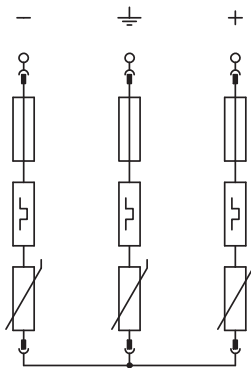

VG-BC DC-TS900

| | | |
|-------------------------------------|-------------------|--------------|
| U max DC | U _c DC | 900 V |
| SPD to EN 61643-11 | | Type 1+2 |
| Lightning protection zone LPZ | | 0-2 |
| Impulse discharge current (10/350) | I _{imp} | 7 kA |
| Nominal discharge current (8/20) | I _n | 30 kA |
| Maximum discharge current (8/20 μs) | I _{max} | 50 kA |
| Protection level | U _o | < 3,0 kV |
| Response time | t _A | < 25 ns |
| Temperature range | θ | -40 - +80 °C |
| Protection rating | | IP65 |
| Connection cross-section string | | 0.5 - 10 |
| Connection cross-section PE | | 0.5 - 10 |

PV system solution, type 1+2, with MC4 connector for inverter with 1 MPP tracker, 900 V DC

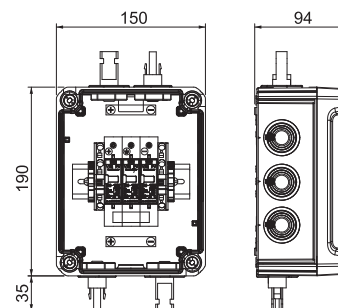
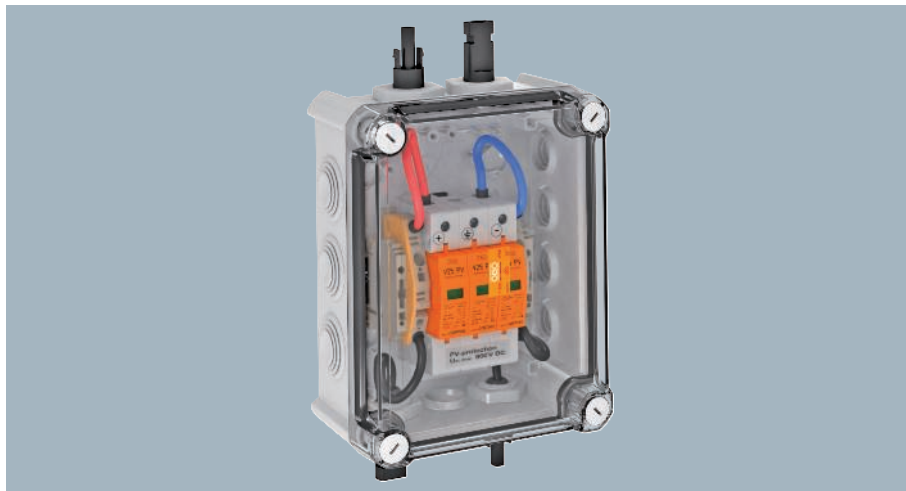

| Type | U max DC V | Version | Pack Piece | Weight kg/100 pc. | Item no. |
|------------|------------|-------------------------------------|------------|-------------------|----------|
| VG-BC900S1 | 900 | For one MPP and with MC4 connection | 1 | 105.000 | 5088564 |

System solution, type 1+2, with MC4 connector for photovoltaic inverter with one MPP tracker

- Varistor arrester, connectable with cut-off unit in error-resistant Y circuit to VDE 0100-712 (50539-12)
- Type 1+2 combination arrester for lightning protection equipotential bonding to EN 62305 (VDE 0185-305)
- Low DC protection level: < 3.0 kV (Voc max = 900 V DC with V25-B+C/0-450PV)
- One PV string input (MC4 plug connector) at one MPP inverter input, up to 30 A DC per terminal
- Pre-mounted in polycarbonate housing (IP65), UV-resistant for use outside

For DC protection of the inverter of photovoltaic systems. If there is a danger of condensation forming through wind, ice, temperature or sunlight, further measures may be necessary!

| VG-BC900S1 | |
|-------------------------------------|-------------------------|
| U max DC | U _c DC 900 V |
| SPD to EN 61643-11 | Type 1+2 |
| Lightning protection zone LPZ | 0→2 |
| Impulse discharge current (10/350) | I _{imp} 7 kA |
| Nominal discharge current (8/20) | I _n 30 kA |
| Maximum discharge current (8/20 μs) | I _{max} 50 kA |
| Protection level | U _p < 3,0 kV |
| Response time | t _A < 25 ns |
| Temperature range | θ -40 - +80 °C |
| Protection rating | IP66 |

Connection options

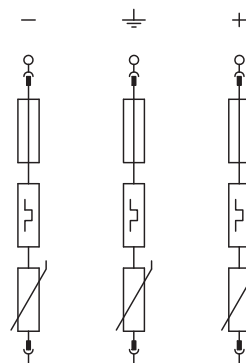



PV system solution, type 1+2, with MC4 connector for inverter with 2 MPP trackers, 900 V DC

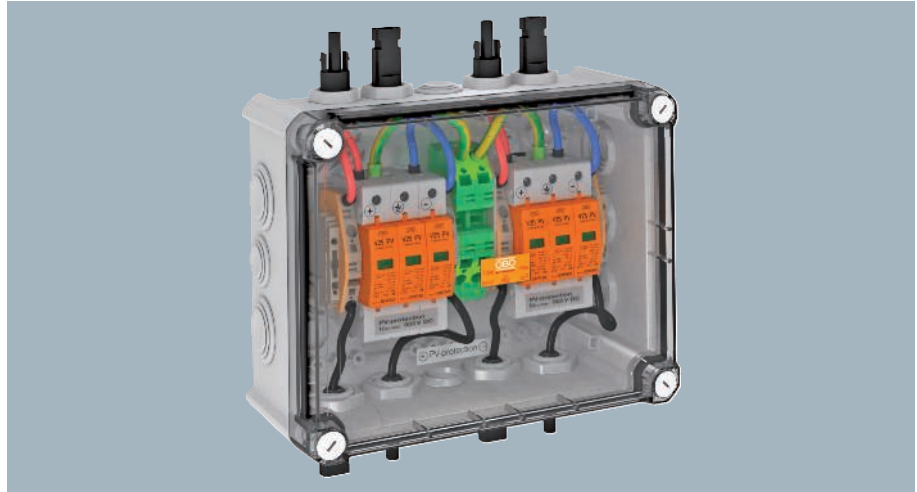
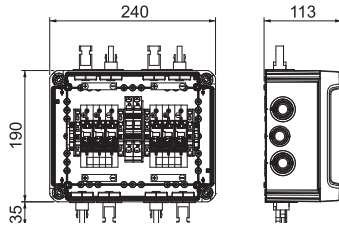

System solution, type 1+2, with MC4 connector for photovoltaic inverter with 2 separate MPP trackers

- Varistor arrester, connectable with cut-off unit in error-resistant Y circuit to VDE 0100-712 (50539-12)
- Type 1+2 combination arrester for lightning protection equipotential bonding to EN 62305 (VDE 0185-305)
- Low DC voltage protection level: < 3.0 kV (Voc max = 900V DC with V25-B+C/0-450PV)
- One PV string input (MC4 plug connector) at one MPP inverter input, up to 30A DC per terminal
- Pre-mounted in polycarbonate housing (IP66), UV-resistant for use outside

For DC protection of the inverter of photovoltaic systems.
If there is a danger of condensation forming through wind, ice, temperature or sunlight, further measures may be necessary!

| Type | Max. continuous voltage DC V | Version | Pack Piece | Weight kg/100 pc. | Item no. |
|-------------|------------------------------|--------------------------------------|------------|-------------------|----------|
| VG-BC900S11 | 900 | For two MPPs and with MC4 connection | 1 | 199.000 | 5088565 |

Connection options

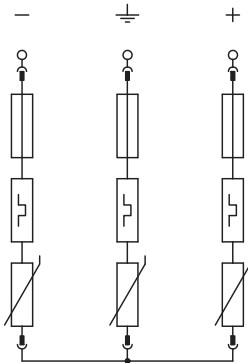

VG-BC900S11

| | | |
|-------------------------------------|-------------------|--------------|
| U max DC | U _c DC | 900 V |
| SPD to EN 61643-11 | | Type 1+2 |
| Lightning protection zone LPZ | | 0-2 |
| Impulse discharge current (10/350) | I _{imp} | 7 kA |
| Nominal discharge current (8/20) | I _n | 30 kA |
| Maximum discharge current (8/20 μs) | I _{max} | 50 kA |
| Protection level | U _o | < 3,0 kV |
| Response time | t _A | < 25 ns |
| Temperature range | θ | -40 - +80 °C |
| Protection rating | | IP66 |



PV housing for inverter with 3 MPP trackers, type 1+2, 900 V DC

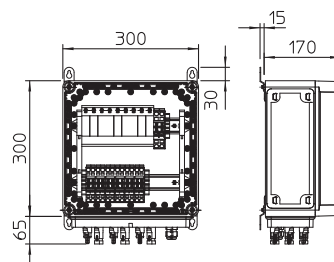
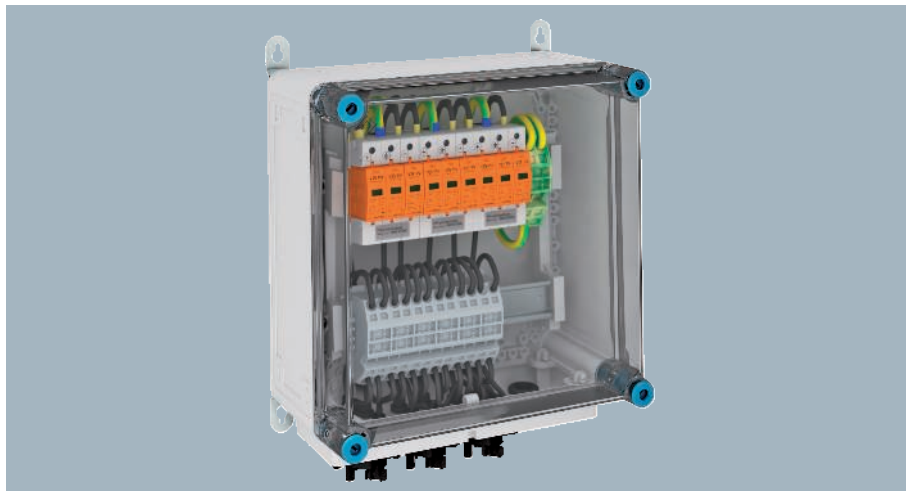

| Type | U max DC V | Version | Pack Piece | Weight kg/100 pc. | Item no. |
|------------------|------------|---------------------------------------|------------|-------------------|----------|
| VG-BC DCPH900-31 | 900 | For three MPP and with MC4 connection | 1 | 542.000 | 5088629 |

System solution with MC4 connector for photovoltaic inverter with 3 separate MPP trackers

- Varistor arrester, connectable with cut-off unit in error-resistant Y circuit to VDE 0100-712 (50539-12)
- Low DC protection level: < 3.0 kV (Voc max = 900 V DC with V25-B+C/0-450PV)
- Two PV string inputs (MC4 plug connector) at one MPP inverter input, up to 30 A DC per terminal
- Pre-mounted in polycarbonate housing (IP65), UV-resistant for the use outside

For DC protection of the inverter of photovoltaic systems. If there is a danger of condensation forming through wind, ice, temperature or sunlight, further measures may be necessary!

VG-BC DCPH900-31

| | | |
|-------------------------------------|-------------------|--------------|
| U max DC | U _c DC | 900 V |
| SPD to EN 61643-11 | | Type 1+2 |
| Lightning protection zone LPZ | | 0→2 |
| Impulse discharge current (10/350) | I _{imp} | 7 kA |
| Nominal discharge current (8/20) | I _n | 30 kA |
| Maximum discharge current (8/20 μs) | I _{max} | 60 kA |
| Protection level | U _p | < 3,0 kV |
| Response time | t _A | < 25 ns |
| Temperature range | θ | -40 - +80 °C |
| Protection rating | | IP65 |

Connection options

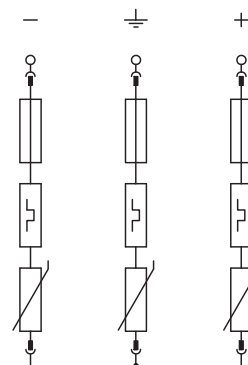



PV system solution, type 2, with MC4 connector for inverter with 1 MPP tracker, 1,000 V DC

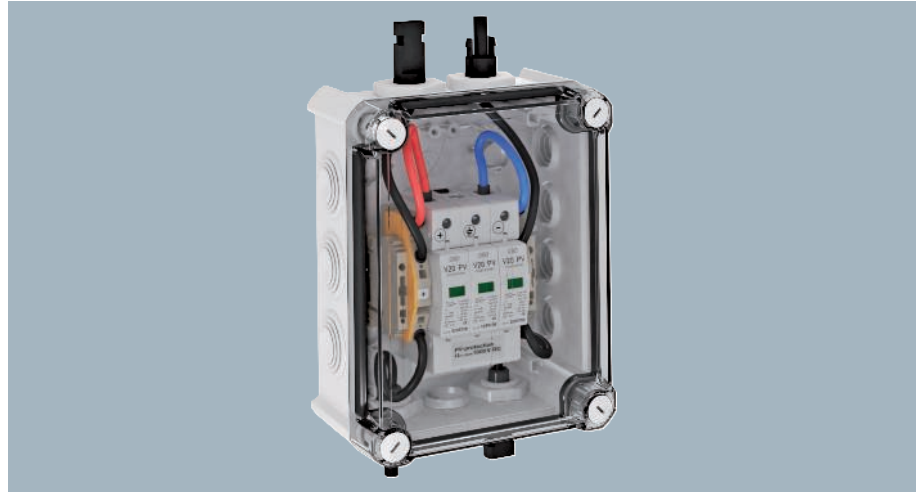
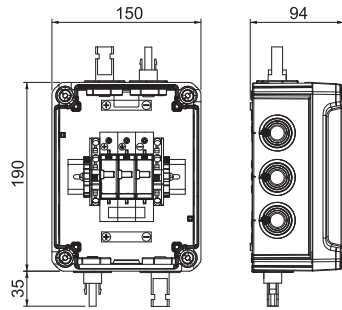

System solution, type 2, with MC4 connector for photovoltaic inverter with 1 MPP tracker

- Varistor arrester, connectable with cut-off unit in error-resistant Y circuit to VDE 0100-712 (50539-12)
- Low DC voltage protection level: < 4.0 kV (Voc max = 1,000V DC with V20-C/0-500PV)
- One PV string input (MC4 plug connector) at one MPP inverter input, up to 30A DC per terminal
- Pre-mounted in polycarbonate housing (IP66), UV-resistant for use outside

For DC protection of the inverter of photovoltaic systems.
If there is a danger of condensation forming through wind, ice, temperature or sunlight, further measures may be necessary!

| Type | U max DC V | Version | Pack Piece | Weight kg/100 pc. | Item no. |
|---------------|------------|---|------------|-------------------|----------|
| PVG-C1000S100 | 1000 | For one MPP tracker and with MC4 connection | 1 | 105.000 | 5088554 |

Connection options

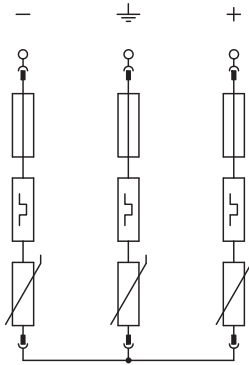

| PVG-C1000S100 | | |
|-------------------------------------|-------------------|--------------|
| U max DC | U _c DC | 1000 V |
| SPD to EN 61643-11 | | Type 2 |
| Lightning protection zone LPZ | | 1→2 |
| Impulse discharge current (10/350) | I _{imp} | — kA |
| Nominal discharge current (8/20) | I _n | 20 kA |
| Maximum discharge current (8/20 μs) | I _{max} | 40 kA |
| Protection level | U _p | < 4,0 kV |
| Response time | t _A | < 25 ns |
| Temperature range | θ | -40 - +80 °C |
| Protection rating | | IP66 |



PV system solution, type 2, with MC4 connector for inverter with 2 MPP trackers, 1,000 V DC

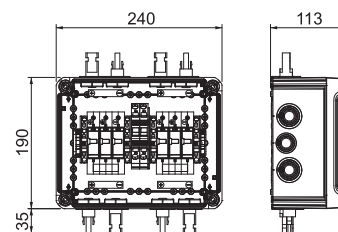
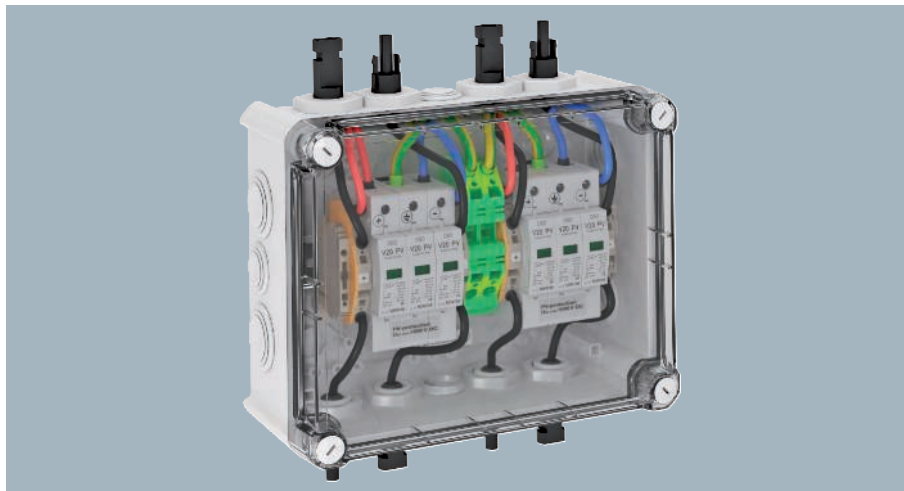

| Type | U max DC V | Version | Pack Piece | Weight kg/100 pc. | Item no. |
|---------------|------------|--|------------|-------------------|----------|
| PVG-C1000S110 | 1000 | For two MPP trackers and with MC4 connection | 1 | 199.000 | 5088556 |

System solution, type 2, with MC4 connector for photovoltaic inverter with 2 separate MPP trackers

- Varistor arrester, connectable with cut-off unit in error-resistant Y circuit to VDE 0100-712 (50539-12)
- Low DC voltage protection level: < 4.0 kV (Voc max = 1,000V DC with V20-C/0-500PV)
- One PV string input (MC4 plug connector) at one MPP inverter input, up to 30A DC per terminal
- Pre-mounted in polycarbonate housing (IP66), UV-resistant for use outside

For DC protection of the inverter of photovoltaic systems. If there is a danger of condensation forming through wind, ice, temperature or sunlight, further measures may be necessary!

| PVG-C1000S110 | |
|-------------------------------------|--------------------------|
| U max DC | U _c DC 1000 V |
| SPD to EN 61643-11 | — |
| Lightning protection zone LPZ | 1→2 |
| Impulse discharge current (10/350) | I _{imp} — kA |
| Nominal discharge current (8/20) | I _n 20 kA |
| Maximum discharge current (8/20 μs) | I _{max} 40 kA |
| Protection level | U _p < 4,0 kV |
| Response time | t _A < 25 ns |
| Temperature range | ϑ -40 - +80 °C |
| Protection rating | IP66 |

Connection options

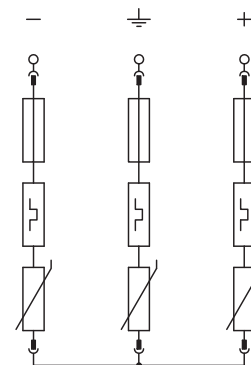



PV CombiController V50, plug-in arrester, type 1+2

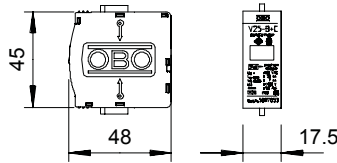

CombiController upper part – type 1+2, combination arrester for photovoltaic systems

- For surge protection equipotential bonding to VDE 0100-443 (IEC 60364-4-44)
- Arresting capacity to 12.5 kA (10/350) and 50 kA (8/20) per pole
- Low DC voltage protection level: < 1.3 kV per pole (Y circuit: 2.6 kV and Voc max = 600 V DC)
- Plug-in arrester with thermodynamic cut-off unit and visual function display
- Encapsulated, zinc oxide varistor arrester for use in distributor housings
- High current carrying capacity with long lifespan

Application: PV systems with lightning protection system

| Type | U max DC V | Version | Pack Piece | Weight kg/100 pc. | Item no. |
|-----------------|------------|---|------------|-------------------|----------|
| V50-B+C 0-300PV | 300 | 1-pole, PV upper part with Y base to 600 V DC | 1 | 8.200 | 5093726 |

Connection options



| V50-B+C 0-300PV | | |
|-------------------------------------|-------------------|--------------|
| U max DC | U _e DC | 300 V |
| SPD to EN 61643-11 | | Type 1+2 |
| SPD to IEC 61643-11 | | Class I+II |
| Lightning protection zone LPZ | | 0-2 |
| Nominal discharge current (8/20) | I _n | 30 kA |
| Impulse discharge current (10/350) | I _{imp} | 12.5 kA |
| Maximum discharge current (8/20 μs) | I _{max} | 50 kA |
| Protection level | U _p | < 1,3 kV |
| Response time | t _A | <25 ns |
| Maximum back-up fuse | | 125 A |
| Temperature range | θ | -40 - +80 °C |
| Protection rating | | IP 20 |
| Division unit TE (17.5 mm) | | 1 |



PV CombiController V25, plug-in arrester, type 1+2

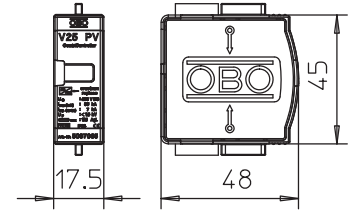

| Type | U max DC V | Version | Pack Piece | Weight kg/100 pc. | Item no. |
|-----------------|------------|---|------------|-------------------|----------|
| V25-B+C 0-450PV | 450 | 1-pole, PV upper part with Y base to 900 V DC | 1 | 9.500 | 5097065 |

CombiController upper part - type 1+2, combination arrester for photovoltaic systems

- For surge protection equipotential bonding to VDE 0100-443 (IEC 60364-4-44)
- Arresting capacity to 7 kA (10/350) and 50 kA (8/20) per pole
- Low DC voltage protection level: < 1.5 kV per pole (Y circuit: 3.0 kV and Voc max = 900 V DC)
- Plug-in arrester with thermodynamic cut-off unit and visual function display
- Encapsulated, zinc oxide varistor arrester for use in distributor housings
- High current carrying capacity with long lifespan

Application: PV systems with lightning protection system

| V25-B+C 0-450PV | |
|-------------------------------------|-------------------------|
| U max DC | U _c DC 450 V |
| SPD to EN 61643-11 | Type 1+2 |
| SPD to IEC 61643-11 | Class I+II |
| Lightning protection zone LPZ | 0-2 |
| Nominal discharge current (8/20) | I _n 30 kA |
| Impulse discharge current (10/350) | I _{imp} 7 kA |
| Maximum discharge current (8/20 μs) | I _{max} 50 kA |
| Protection level | U _p < 1,5 kV |
| Response time | t _A < 25 ns |
| Maximum back-up fuse | 160 A |
| Temperature range | θ -40 - +80 °C |
| Protection rating | IP 20 |
| Division unit TE (17.5 mm) | 1 |

Connection options





PV SurgeController V20, plug-in arrester, type 2

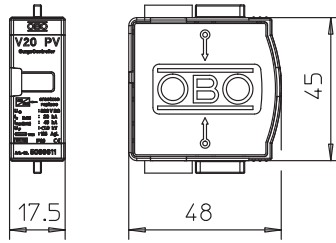

SurgeController upper part - type 2, surge arrester for photovoltaic systems

- For surge protection equipotential bonding to VDE 0100-443 (IEC 60364-4-44)
- Arresting capacity to 40 kA (8/20) per pole
- Low DC voltage protection level: < 1.3 kV per pole (Y circuit: 2.6 kV and Voc max = 600 V DC)
- Plug-in arrester with thermodynamic cut-off unit and visual function display
- Encapsulated, non-extinguishing zinc oxide varistor arrester for use in distributor housings
- High current carrying capacity with long lifespan

Application example: PV systems with or without separated insulated lightning protection system

| Type | U max DC V | Version | Pack Piece | Weight kg/100 pc. | Item no. |
|---------------|------------|---|------------|-------------------|----------|
| V20-C 0-300PV | 300 | 1-pole, PV upper part with Y base to 600 V DC | 1 | 5.500 | 5099611 |

Connection options



V20-C 0-300PV

| | | |
|-------------------------------------|-------------------|--------------|
| U max DC | U _c DC | 300 V |
| SPD to EN 61643-11 | | Type 2 |
| SPD to IEC 61643-11 | | Class II |
| Lightning protection zone LPZ | | 1→2 |
| Nominal discharge current (8/20) | I _n | 20 kA |
| Maximum discharge current (8/20 μs) | I _{max} | 40 kA |
| Protection level | U _p | < 1,3 kV |
| Response time | t _A | < 25 ns |
| Maximum back-up fuse | | 125 A |
| Temperature range | θ | -40 - +80 °C |
| Protection rating | | IP 20 |
| Division unit TE (17.5 mm) | | 1 |



PV SurgeController V20, plug-in arrester, type 2

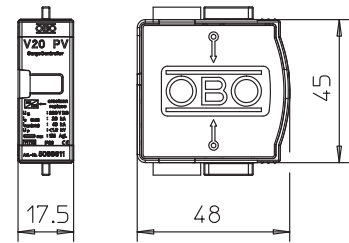

| Type | U max DC V | Version | Pack Piece | Weight kg/100 pc. | Item no. |
|---------------|------------|---|------------|-------------------|----------|
| V20-C 0-500PV | 500 | 1-pole, PV upper part with Y base to 1,000 V DC | 1 | 6.500 | 5099708 |

SurgeController upper part - type 2, surge arrester for photovoltaic systems

- For surge protection equipotential bonding to VDE 0100-443 (IEC 60364-4-44)
- Arresting capacity to 40 kA (8/20) per pole
- Low DC voltage protection level: < 2.0 kV per pole (Y circuit: 4.0 kV and Voc max = 1,000 V DC)
- Plug-in arrester with thermodynamic cut-off unit and visual function display
- Encapsulated, non-extinguishing zinc oxide varistor arrester for use in distributor housings
- High current carrying capacity with long lifespan

Application example: PV systems with or without separated insulated lightning protection system

| V20-C 0-500PV | |
|-------------------------------------|-------------------------|
| U max DC | U _c DC 500 V |
| SPD to EN 61643-11 | Type 2 |
| SPD to IEC 61643-11 | Class II |
| Lightning protection zone LPZ | 1→2 |
| Nominal discharge current (8/20) | I _n 20 kA |
| Maximum discharge current (8/20 μs) | I _{max} 40 kA |
| Protection level | U _p < 2,0 kV |
| Response time | t _A < 25 ns |
| Maximum back-up fuse | 125 A |
| Temperature range | ϑ -40 - +80 °C |
| Protection rating | IP 20 |
| Division unit TE (17,5 mm) | 1 |

Connection options



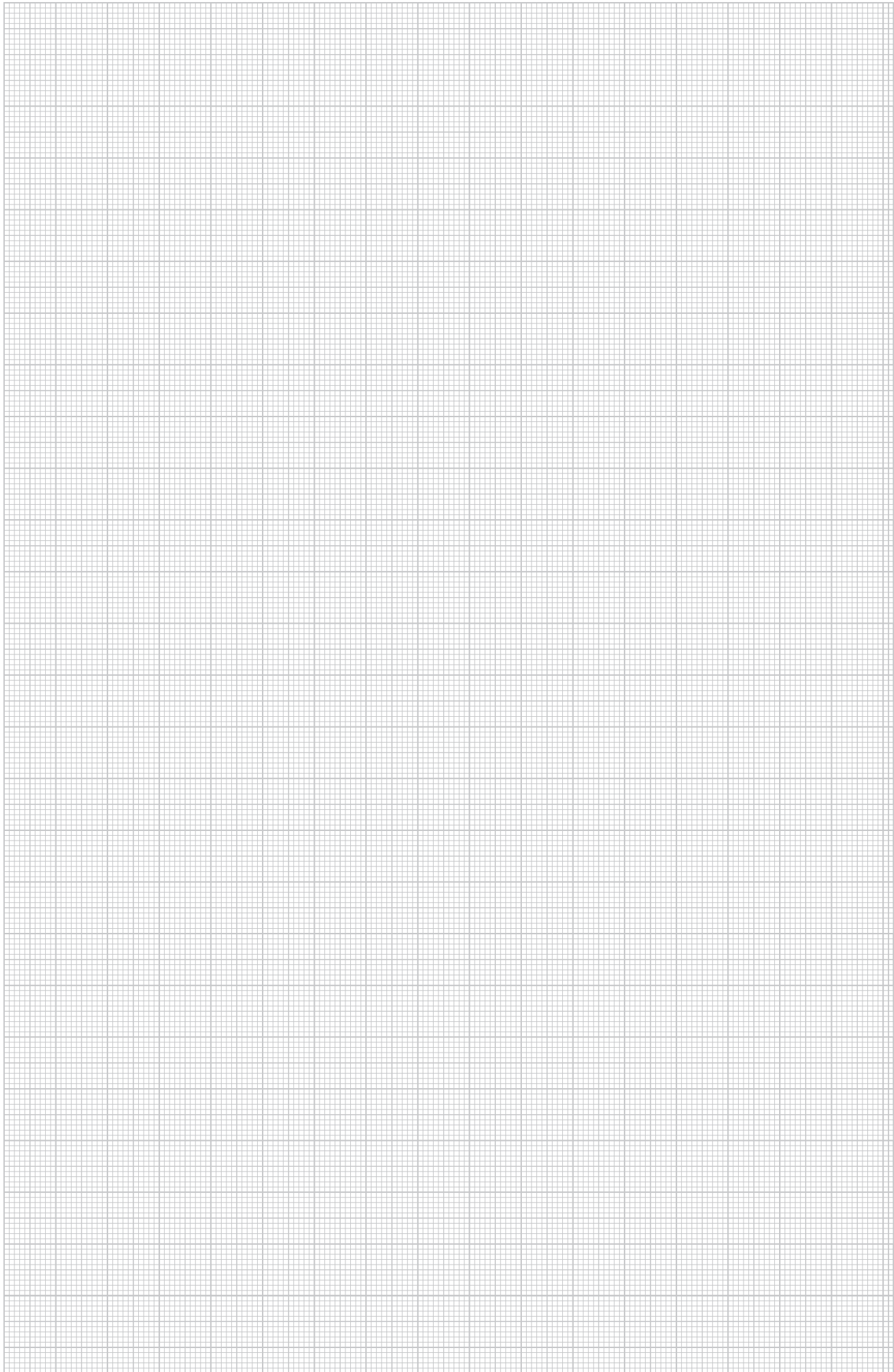

LSC I+II lightning strike and surge counter

Lightning strike and surge counter for the recording of lightning and impulse currents with date and time



IP65 – suitable for outdoor use

Tested to EN/IEC 62561-6

Lightning strike and surge counter can count up to 999 lightning occurrences noting date and time

Exchangeable lithium battery with a lifespan of up to 5 years

Metering range 1 to 100 kA

The LSC I+II lightning current meter measures and permanently saves lightning and pulse currents (10/350), (8/20) and saves this event together with the date and time. This ensures constant monitoring in order to notice if any lightning has struck the lightning protection system or whether there have

been any surge voltages in the system. If a lightning or surge voltage event has occurred, then the entire lightning protection system must be maintained according to VDE 0185-305 (IEC 62305).

Lightning strike counter



| Type | Measuring range | Pack Piece | Weight kg/100 pc. | Item no. |
|----------|-----------------|------------|-------------------|----------|
| LSC I+II | 1 kA - 100 kA | 1 | 32.500 | 5091722 |

The LSC I+II lightning current meter measures and permanently saves pulse currents, together with the date and time. This ensures constant monitoring in order to notice if any lightning has struck the lightning protection system. Should this be the case, then the lightning protection system must be maintained according to VDE 0185-305 (IEC 62305).

- Saving and display of time and date
- Usable both inside and outside due to its protection class of IP65
- Cable clip for round conductor or flat conductor
- Direct mounting on the conductor or the PE conductor of the surge protective device
- Long lifespan of the internal lithium batteries
- LCD display
- Internal battery
- Tested according to VDE 0185-561-6 (IEC 62561-6)

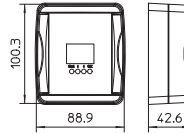

Testing devices



ISOLAB measuring system arrester tester

| Type | Country version | Nom. voltage V | Measuring range | Pack Piece | Weight kg/100 pc. | Item no. |
|--------|-----------------|----------------|-----------------|------------|-------------------|----------|
| ISOLAB | D/GB | 6 | 0V - 999V | 1 | 75.000 | 5096812 |

To test the insulation resistance to DIN VDE 0100 Part 610 and the characteristic curve behaviour of the following surge voltage and lightning current arresters:

- V10-C and V20-C: Uc Tolerance range
 - 75 V -> 110 V - 130 V
 - 150 V -> 215 V - 265 V
 - 280 V -> 385 V - 475 V
 - 320 V -> 460 V - 560 V
 - 335 V -> 460 V - 560 V
 - 385 V -> 560 V - 680 V
 - 440 V -> 645 V - 785 V
 - 550 V -> 820 V - 1,000 V

- V25-B+C and V50-B+C: Uc Tolerance range
 - 150 V -> 215 V - 265 V
 - 280 V -> 385 V - 475 V
 - 320 V -> 460 V - 560 V
 - 385 V -> 560 V - 680 V

- Varistor arresters of other manufacturers can be tested for 1 or 3 mA characteristic curve behaviour
- Battery operation
- Measuring cables contained in the scope of delivery.

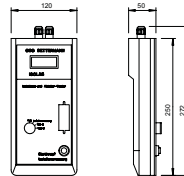

Testing unit for lightning barriers

| Type | Pack Piece | Weight kg/100 pc. | Item no. |
|------|------------|-------------------|----------|
| LFC | 1 | 164.500 | 5096786 |

OBO Life Control allows function control of the MDP lightning barriers. The lightning barriers can be checked while installed. Life Control will not have any influences on the measuring signal. Life Control possesses an integrated OLED with visual and acoustic defect signalling. A separate LED inside the testing pin is also integrated. Life Control is delivered in a case, complete with a CD and instructions.

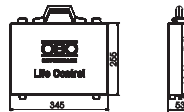

Card reader PCS-CS..

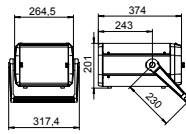

| Type | Country version | Nom. voltage V | Measuring range | Measuring tolerances | Pack Piece | Weight kg/100 pc. | Item no. |
|----------|-----------------|----------------|-----------------|----------------------|------------|-------------------|----------|
| PCS-CS-D | EN | 230 | 3--120 kA | <2 kA (<2%) | 1 | 750.000 | 5091683 |

Magnetic card reader for reading and analysing PCS cards.

- Inc. rechargeable battery for 4 h continuous, no-mains operation
- Large, clear display

Magnetic cards and holders



Magnetic card PCS

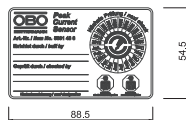

| Type | Pack PU | Weight kg/100 PUs | Item no. |
|------|---------|-------------------|----------|
| PCS | 1 | 5.000 | 5091438 |

Peak Current Sensor (PCS) card for recording pulsed/lightning currents. A continuous check of whether lightning has struck the lightning protection system and how high the most recent lightning current was in kA can be carried out easily by the system operator, a specialist lightning protection company or by a surveyor. Here, the printed maintenance circuit and the labelling panels support the maintenance work of the entire lightning protection system, which must be performed at defined intervals according to VDE 0185-305-3 (IEC/EN 62305-3).

- Contents = 10 pieces
- Digital evaluation via the PCS card reading device
- Can be used in addition to the OBO lightning current meter LSC I-II
- With separate labelling panels: "Erected by", "Tested by", "Card code"
- Integrated maintenance circuit (year/month)

Magnetic card and holder MK-B

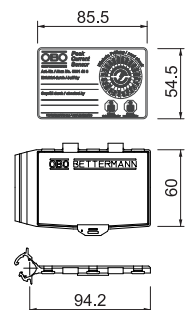

| Type | Pack PU | Weight kg/100 PUs | Item no. |
|------|---------|-------------------|----------|
| MK-B | 1 | 31.000 | 5091322 |

PCS magnetic card to record pulse/lightning currents including holder

- Holder can be leaded
- For mounting on round conductor Rd 8-10
- Simple holder mounting through clamping
- 1 PU = 10 units





Magnetic card holder PCS-H

| Type | Pack PU | Weight kg/100 PUs | Item no. |
|-------|---------|-------------------|----------|
| PCS-H | 1 | 31.000 | 5091527 |

Magnetic card holder for mounting PCS cards.

- Sealable holder
- For installing on round conductor Rd 8-10
- Simple holder installation by means of clamp
- 1 PU = 10 pieces

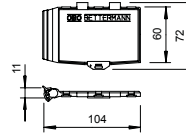

Coordinated Lightning Controller, plug-in arrester

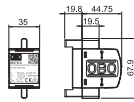
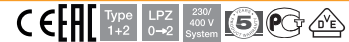

| | | | | | | |
|----------------------------|-----|---------|--|-------|------------|----------------|
| Highest continuous voltage | | | | Pack | Weight | |
| Type | V | Version | | Piece | kg/100 pc. | Item no. |
| MCD 50-B 0 | 255 | 1-pole | | 1 | 19.200 | 5096822 |

Combination arrester type 1+2

- Lightning current arresting capacity 50 kA (10/350)
- Protection level < 1.7 kV
- Line current quenching capacity 10 kA
- Encapsulated, non-extinguishing spark gap

Application: Industrial systems and buildings with external lightning protection of classes I to IV.

Connection options

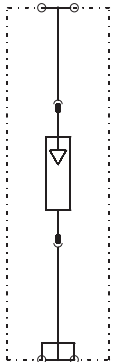

MCD 50-B 0

| | | |
|--|------------------|-------------------------|
| Nominal voltage | U_N | 230 V |
| SPD to EN 61643-11 | | Type 1+2 |
| SPD to IEC 61643-11 | | Class I+II |
| Lightning protection zone LPZ | | 0→2 |
| Impulse discharge current (10/350) | I_{imp} | 50 kA |
| Lightning surge current (10/350) | I_{total} | 50 kA |
| Nominal discharge current (8/20) | I_n | 50 kA |
| Arrestor surge current (8/20) [total] | $I_{Total 8/20}$ | 50 kA |
| Protection level | U_d | < 1,7 kV |
| Response time | t_A | <100 ns |
| Follow current quenching capacity leff | $I_{fi eff}$ | 10 kA |
| Maximum back-up fuse | | 500 A |
| Temperature range | ϑ | -40 - +85 °C |
| Division unit TE (17.5 mm) | | 2 |
| Protection rating | | IP20 |
| Approvals | | VDE |
| Connection cross-section, rigid | | 10 - 50 mm ² |
| Connection cross-section, multi-wire | | 10 - 35 mm ² |
| Connection cross-section, flexible | | 10 - 25 mm ² |

Plug-in arrester NPE-C50

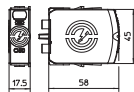
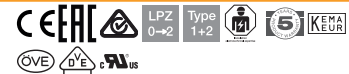

| | | | | | | |
|-------------------------|------|--------------|-------------------|-------|------------|----------------|
| Max. continuous voltage | | | | Pack | Weight | |
| Type | AC V | Pole version | Protection rating | Piece | kg/100 pc. | Item no. |
| C50-0-255 | 255 | N/PE | IP20 | 1 | 7.215 | 5095609 |

Upper part NPE, lightning current combination arrester, type 1+2

- For lightning protection equipotential bonding to VDE 0185-305 (IEC 62305)
- Lightning current discharge capacity up to 50 kA (10/350) in total
- Modular, plug-in arrester with dynamic cut-off unit and visual status display
- Locking mechanism with vibration protection and voltage keying
- Plastic according to UL 94 V-0

Connection options



C50-0-255

| | | |
|--|--------------|--------------------------|
| SPD to EN 61643-11 | | Type 1+2 |
| SPD to IEC 61643-11 | | Class I+II |
| SPD to UL 1449 | | Type 4 |
| Maximum continuous voltage AC | U_C | 255 V |
| Nominal discharge current (8/20 μs) | $I_{n/L-N}$ | 30 kA |
| Maximum discharge current (8/20 μs) | I_{max} | 50 kA |
| Lightning surge current (10/350 μs) | I_{imp} | 50 kA |
| Protection level [N-PE] | $U_{d/N-PE}$ | 1.5 kV |
| Short-circuit withstand for max. mains-side overcurrent protection | | 25 kA |
| Operating temperature range | T_u | -40 - +80 °C |
| Protection rating | | IP20 |
| Approvals | | UL, KEMA, ÖVE, VDE |
| Conductor cross-section, flexible (fine-wire) | | 1.5 - 35 mm ² |
| Conductor cross-section, rigid (single wire/multi-wire) | | 1.5 - 35 mm ² |
| Conductor cross-section, flexible (fine-wire) | | 16 - 2 AWG |
| Conductor cross-section, rigid (single wire/multi-wire) | | 16 - 2 AWG |



Plug-in arrester V20 280 V

| Type | Max. continuous voltage AC V | Pole version | Protection rating | Pack Piece | Weight kg/100 pc. | Item no. |
|-----------|------------------------------|--------------|-------------------|------------|-------------------|----------|
| V20-0-280 | 280 | 1 | IP20 | 1 | 5.000 | 5095364 |

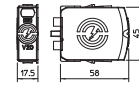

Surge arrester, type 2

- For surge protection equipotential bonding to VDE 0100-443 (IEC 60364-4-44)
- Discharge capacity to 40 kA (8/20) per pole through high-performance varistors
- Modular, plug-in arrester with dynamic cut-off unit and visual status display
- Locking mechanism with vibration protection and voltage keying
- Plastic (UL 94 V-0)

V20-0-280

| | | |
|--|-------------|--------------------|
| SPD to EN 61643-11 | | Type 2 |
| SPD to IEC 61643-11 | | Class II |
| SPD to UL 1449 | | Type 4 |
| Nominal voltage AC (50/60 Hz) | U_n | 230 V |
| Maximum continuous voltage AC | U_c | 280 V |
| Protection level | U_p | 1.3 kV |
| Nominal discharge current (8/20 μ s) | $I_n / L-N$ | 20 kA |
| Maximum discharge current (8/20 μ s) | I_{max} | 40 kA |
| Operating temperature range | T_u | -40 - +80 °C |
| Protection rating | | IP20 |
| Approvals | | UL, ÖVE, VDE, KEMA |

Connection options

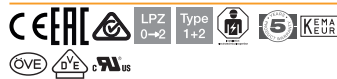

Plug-in arrester V50 280 V

| Type | Max. continuous voltage AC V | Pole version | Protection rating | Pack Piece | Weight kg/100 pc. | Item no. |
|-----------|------------------------------|--------------|-------------------|------------|-------------------|----------|
| V50-0-280 | 280 | 1 | IP20 | 1 | 8.500 | 5093508 |

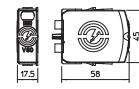

Combination arrester, type 1+2

- For lightning protection equipotential bonding to VDE 0185-305 (IEC 62305)
- Lightning current discharge capacity of 12.5 kA (10/350) per pole
- Modular, plug-in arrester with dynamic cut-off unit and visual status display
- Locking mechanism with vibration protection and voltage keying
- Plastic (UL 94 V-0)

V50-0-280

| | | |
|--|-------------|--------------------|
| SPD to EN 61643-11 | | Type 1+2 |
| SPD to IEC 61643-11 | | Class I+II |
| SPD to UL 1449 | | Type 4 |
| Nominal voltage AC (50/60 Hz) | U_n | 230 V |
| Maximum continuous voltage AC | U_c | 280 V |
| Lightning surge current (10/350 μ s) | I_{imp} | 12.5 kA |
| Nominal discharge current (8/20 μ s) | $I_n / L-N$ | 30 kA |
| Maximum discharge current (8/20 μ s) | I_{max} | 50 kA |
| Short-circuit withstand for max. mains-side overcurrent protection | | 50 kA eff |
| Operating temperature range | T_u | -40 - +80 °C |
| Protection rating | | IP20 |
| Approvals | | UL, KEMA, ÖVE, VDE |

Connection options



Connection terminal for through-wiring

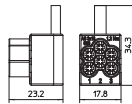
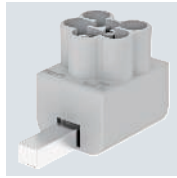

| Type | Colour | Version | Pack Piece | Weight kg/100 pc. | Item no. |
|---------|------------|------------------------|------------|-------------------|----------|
| AS 3x16 | Light grey | 3 x 16 mm ² | 5 | 2.474 | 5012010 |

Connection terminal type: AS 3 x 16
 Connection cross-section: 3 x 1.5 - 16 mm² rigid/ multiple strands
 3 x 1.5 - 10 mm² fine-wire/with wire end sleeve
 Stripping length: 16 mm
 Rec. tightening torque: 1.2 Nm
 Nominal current: 50 A
 Width: 17.5 mm (1 PU)

For EMC-optimised V through-wiring to IEC 60364-5-53 (VDE 0100-534).

Accessories for lightning current arrester

Cu

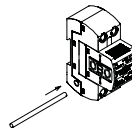

| Type | Pack Piece | Weight kg/100 pc. | Item no. |
|-------|------------|-------------------|----------|
| MC V3 | 10 | 1.700 | 5096884 |
| MC V4 | 10 | 2.300 | 5096886 |

Copper bridge 16 mm², suitable for bridging MC arresters in side channel.

- V3 for 3-pole circuits
- V4 for 4-pole circuits

Connecting bridge for V10 Compact 200 mm

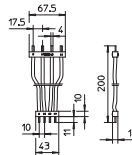

| Type | Version | Pack Piece | Weight kg/100 pc. | Item no. |
|------------------|---------|------------|-------------------|----------|
| VB-V10 COMPACT-2 | 200 mm | 1 | 5.300 | 5089650 |

To bridge V10 Compact e.g. to FI protection switches in a 17.5 mm grid.

- 4-pole version (L1; L2; L3; N)
- Conductor: H07V-K 4 mm²
- V10 Compact connection via pin contact (diameter: 2.7 mm)
- FI protection switch connection via flat contact (4 x 1.5 mm)

Copper bridge with step width 17.6 mm

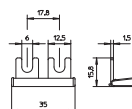

| Type | Pack Piece | Weight kg/100 pc. | Item no. |
|-------|------------|-------------------|----------|
| KB MB | 10 | 0.900 | 5089660 |

The bridges KB... permit parallel connection of bases and poles of the MultiBase bases.
 The bridges are available in various widths.

Copper bridge with step width 17.6 mm

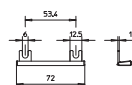

| Type | Pack Piece | Weight kg/100 pc. | Item no. |
|-------|------------|-------------------|----------|
| KB MB | 10 | 1.470 | 5089662 |

The bridges KB... permit parallel connection of bases and poles of the MultiBase bases.
 The bridges are available in various widths.

VA



Mounting plate, 1-pole

| Type | Version | Pack Piece | Weight kg/100 pc. | Item no. |
|-----------|---------|------------|-------------------|----------|
| MCF-MS-P1 | 1-pole | 1 | 19.600 | 5096992 |

Mounting plate 1-pole

- Mounting plate for installation of the arrester MCF 35-1+FS-440
- Prefabricated hole pattern for mounting the arrester on busbars
- Required screws for installation of the arrester enclosed

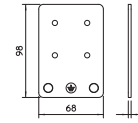

VA



Mounting plate, 1-pole, M10

| Type | Version | Pack Piece | Weight kg/100 pc. | Item no. |
|------------|---------|------------|-------------------|----------|
| MCF-MS-M10 | 1-pole | 1 | 14.200 | 5096990 |

Mounting plate with threaded connector M10

- Mounting plate with threaded M10 connector to install the arrester MCF 35-1+FS-440
- M10 bolts for direct installation of the arrester on busbars
- Required screws for installation enclosed

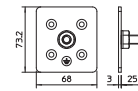

VA



Mounting plate, 3-pole

| Type | Version | Pack Piece | Weight kg/100 pc. | Item no. |
|-----------|---------|------------|-------------------|----------|
| MCF-MS-P3 | 3-pole | 1 | 99.800 | 5096994 |

Mounting plate 3-pole

- Mounting plate 3-pole for installation of the arrester MCF 35-1+FS-440
- Prefabricated hole pattern for mounting the arrester on busbars
- Suitable for wall mounting
- Required screws for installation enclosed

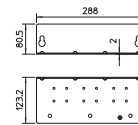

Empty housing for arrestors



Replacement connector for VF remote signalling

| Type | Version | Pack Piece | Weight kg/100 pc. | Item no. |
|-------|---------|------------|-------------------|----------|
| VF-FS | 3-pole | 25 | 0.320 | 5098475 |

Replacement telephony connector, 3-pin version, for VF variant

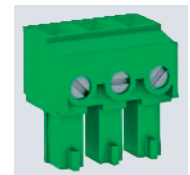
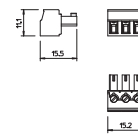

Earthing strip

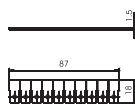

| Type | Pack Piece | Weight kg/100 pc. | Item no. |
|---------------------|------------|-------------------|----------------|
| VB-MDP 10-MD | 1 | 2.300 | 5098470 |

Connecting bridge for 8 mm lightning barriers

- Length of bridge can be adjusted
- Material: Copper
- Allows quick equipotential bonding

Application: Parallel switching of the MDP lightning barriers

Voltage tap for MCF-NAR series

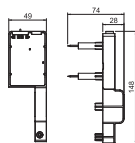
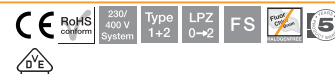

| Type | Nominal voltage AC (50/60 Hz) V | Protection rating | Pack Piece | Weight kg/100 pc. | Item no. |
|--------------------|---------------------------------|-------------------|------------|-------------------|----------------|
| MCF-NAR-SMG | 230 | IP20 | 1 | 5.850 | 5096900 |

Adapter for voltage tap in power-side connection compartment

- Simple and space-saving voltage taps for the termination point meter position (APZ) and the space for additional applications (RfZ)
- With spring contacts for easy connection of wires
- Includes 2 plug sockets
- Safety screw to prevent unwanted loosening
- Replaceable 5 A fine-wire fuse with a breaking capacity of 50 kA
- Fuse holder 6,3 x 32 mm



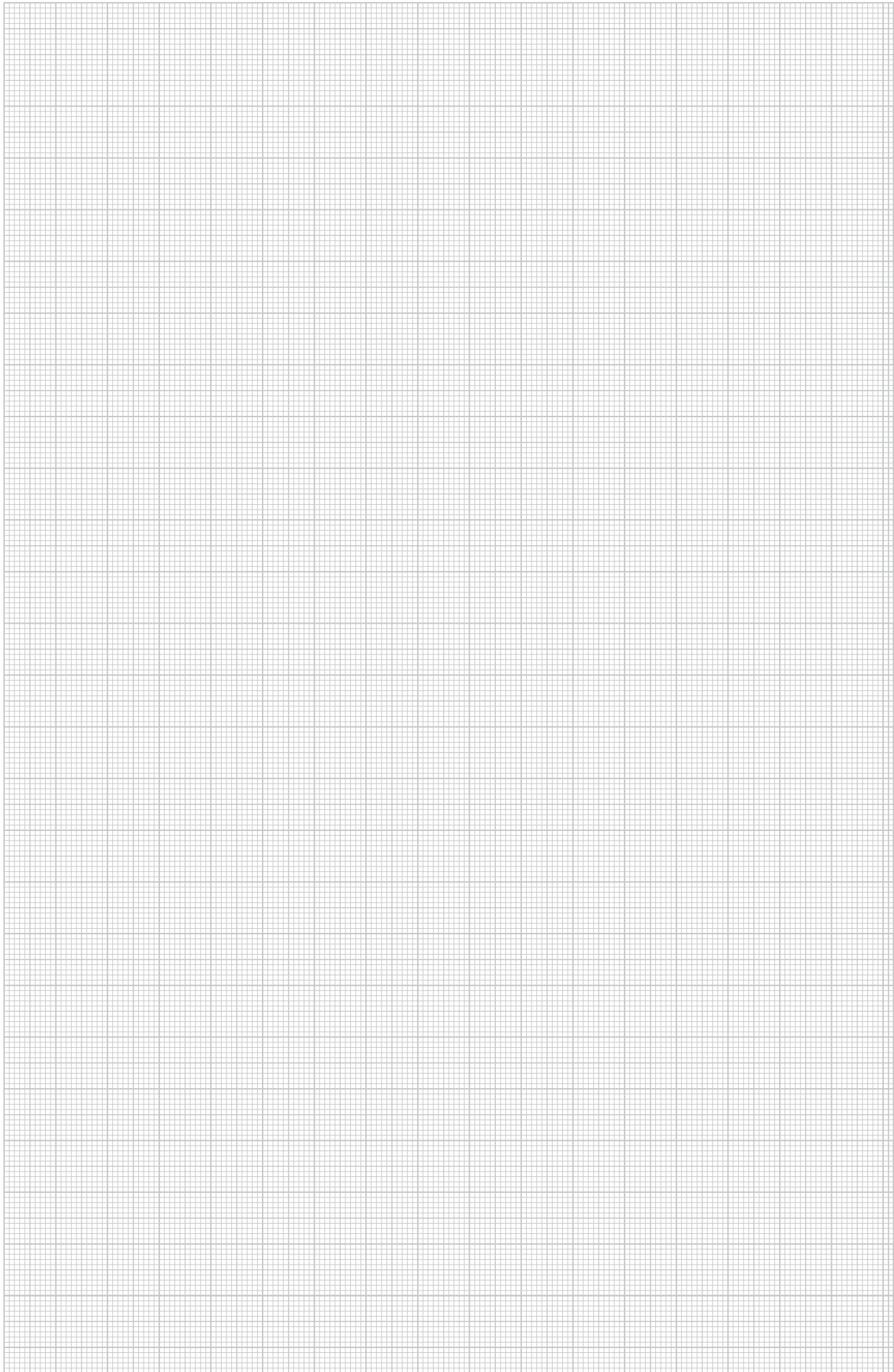





Explosion protection



Explosion protection

| | | |
|---|-----------------------|-----|
|  | Surge protection | 222 |
|  | Spark gaps | 232 |
|  | Equipotential bonding | 236 |
|  | Conductors | 240 |



MDP Ex family

MCR protection for Ex areas



- Protection device for multi-wire systems (4-pole)
- Direct shield earthing
- Easy-mounting, screwless connection option
- Space-saving width of just 8.7 mm
- Ex-tested for intrinsically safe measuring circuits
- High frequency bandwidth up to 100 MHz

Surge protection in potentially explosive areas is an important topic. Here, it is important to protect costly measuring technology against the influence of surge voltages through atmospheric discharge. OBO lightning barriers are tested for intrinsic safety

(ia) and are independently certified. With a high arresting capacity of 10 kA, they offer optimum protection for four-pole measurement and control applications. Different voltage variants offer a wide range of applications.



Series protection device, 4-pole, 5 V version

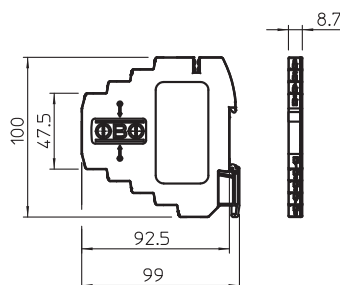

Lightning barrier for intrinsically safe measuring circuits

- Protection device for multi-wire systems
- Direct shield earthing and screwless connection terminals
- Space-saving width of just 8.7 mm
- High frequency range of 0–100 MHz
- ATEX approval: II 2(1) G Ex ia [ja Ga] IIC T4 (BVS 11 ATEX E 131 X)
- UL-listed (4UM2)

Application: Universal use on 35 mm DIN profile rail in any standard distribution housing.

| Type | Max. continuous voltage AC V | Max. continuous voltage DC V | Number of poles | Pack Piece | Weight kg/100 pc. | Item no. |
|--------------|------------------------------|------------------------------|-----------------|------------|-------------------|----------|
| MDP-4 D-5-EX | 7 | 10 | 4 | 1 | 5.800 | 5098412 |

Connection options

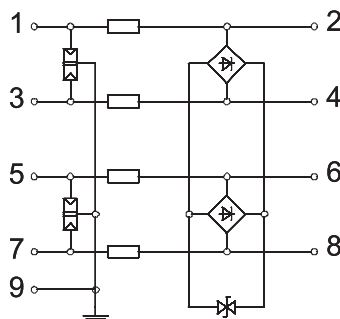

MDP-4 D-5-EX

| | | |
|--------------------------------------|-------------|-------------------------------------|
| Maximum continuous voltage AC | U_c | 7 V |
| Maximum continuous voltage DC | U_c | 10 V |
| Category | Type | 1+2+3 / D1+C2+C1 |
| Lightning protection zone LPZ | | 0→3 |
| Number of poles | | 4 |
| Rated current | I_L | 0.58 A |
| Series resistance per wire | | 2,35 Ω \pm 5 % |
| Impulse durability wire-wire | | C1: 0,5 kV / 0,25 kA (8/20 μ s) |
| Impulse durability wire-earth | | C2: 5 kV / 2,5 kA (8/20 μ s) |
| Total discharge current (8/20) | | 10 kA |
| Total discharge current (10/350) | | D1: 2 kA |
| Protection level wire-wire | | < 35 V |
| Protection level wire-earth | | < 800 V |
| Frequency range | | 0-100 MHz |
| Temperature range | ϑ | -40 - +80 °C |
| Installation type | | DIN rail |
| Connection system | | Terminal |
| Protection rating | | IP20 |
| Shielding connection available | | Yes |
| Shield connection | | Direct |
| Connection cross-section, flexible | | 0.14 - 2.5 mm ² |
| Connection cross-section, multi-wire | | 0.14 - 1.5 mm ² |
| Connection cross-section, rigid | | 0.14 - 2.5 mm ² |
| Earthing via: | | DIN rail |
| EX approval | | II 2(1)G Ex ia [ja Ga] IIC T4 Gb |
| Testing standard | | IEC 61643-21 |
| Approvals | | UL |

Series protection device, 4-pole, 24 V version

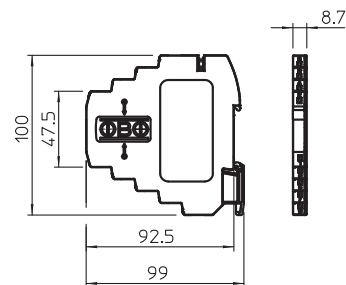

| Type | Max. continuous voltage AC V | Max. continuous voltage DC V | Number of poles | Pack Piece | Weight kg/100 pc. | Item no. |
|----------------------|------------------------------|------------------------------|-----------------|------------|-------------------|----------------|
| MDP-4 D-24-EX | 20 | 28 | 4 | 1 | 5.800 | 5098432 |

Lightning barrier for intrinsically safe measuring circuits

- Protection device for multi-wire systems
- Direct shield earthing and screwless connection terminals
- Space-saving width of just 8.7 mm
- High frequency range of 0–100 MHz
- ATEX approval: II 2(1) G Ex ia [ia Ga] IIC T4 (BVS 11 ATEX E 131 X)
- UL-listed (4UM2)

Application: Universal use on 35 mm DIN profile rail in any standard distribution housing.

MDP-4 D-24-EX

| | | |
|--------------------------------------|-------------|-------------------------------------|
| Maximum continuous voltage AC | U_c | 20 V |
| Maximum continuous voltage DC | U_c | 28 V |
| Category | | Type 1+2+3 / D1+C2+C1 |
| Lightning protection zone LPZ | | 0→3 |
| Number of poles | | 4 |
| Rated current | I_L | 0.58 A |
| Series resistance per wire | | 2,35 $\Omega \pm 5\%$ |
| Impulse durability wire-wire | | C1: 0,5 kV / 0,25 kA (8/20 μ s) |
| Impulse durability wire-earth | | C2: 5 kV / 2,5 kA (8/20 μ s) |
| Total discharge current (8/20) | | 10 kA |
| Total discharge current (10/350) | | D1: 2 kA |
| Protection level wire-wire | | < 55 V |
| Protection level wire-earth | | <800 V |
| Frequency range | | 0-100 MHz |
| Temperature range | ϑ | -40 - +80 °C |
| Installation type | | DIN rail |
| Connection system | | Terminal |
| Protection rating | | IP20 |
| Shielding connection available | | Yes |
| Shield connection | | Direct |
| Connection cross-section, flexible | | 0.14 - 2.5 mm ² |
| Connection cross-section, multi-wire | | 0.14 - 1.5 mm ² |
| Connection cross-section, rigid | | 0.14 - 2.5 mm ² |
| Earthing via: | | DIN rail |
| EX approval | | II 2(1)G Ex ia [ia Ga] IIC T4 Gb |
| Testing standard | | IEC 61643-21 |
| Approvals | | UL |

Connection options

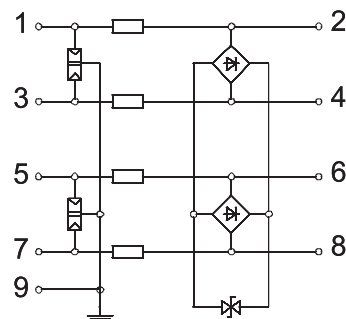



Series protection device, 4-pole, 48 V version

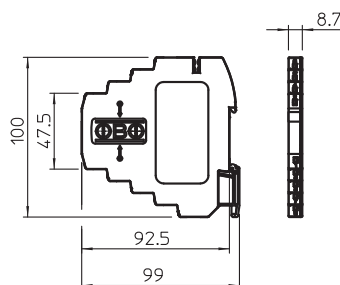

Lightning barrier for intrinsically safe measuring circuits

- Protection device for multi-wire systems
- Direct shield earthing and screwless connection terminals
- Space-saving width of just 8.7 mm
- High frequency range of 0–100 MHz
- ATEX approval: II 2(1) G Ex ia [ja Ga] IIC T4 (BVS 11 ATEX E 131 X)
- UL-listed (4UM2)

Application: Universal use on 35 mm DIN profile rail in any standard distribution housing.

| Type | Max. continuous AC voltage V | Max. continuous DC voltage V | Number of poles | Pack Piece | Weight kg/100 pc. | Item no. |
|----------------------|------------------------------|------------------------------|-----------------|------------|-------------------|----------------|
| MDP-4 D-48-EX | 41 | 58 | 4 | 1 | 5.800 | 5098452 |

Connection options

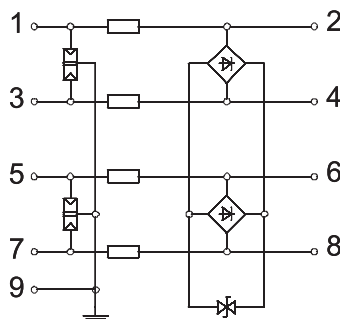
**MDP-4 D-48-EX**

| | | |
|--------------------------------------|-------------|-------------------------------------|
| Maximum continuous voltage AC | U_c | 41 V |
| Maximum continuous voltage DC | U_c | 58 V |
| Category | | Type 1+2+3 / D1+C2+C1 |
| Lightning protection zone LPZ | | 0→3 |
| Number of poles | | 4 |
| Rated current | I_L | 0.58 A |
| Series resistance per wire | | 2,35 Ω \pm 5 % |
| Impulse durability wire-wire | | C1: 0,5 kV / 0,25 kA (8/20 μ s) |
| Impulse durability wire-earth | | C2: 5 kV / 2,5 kA (8/20 μ s) |
| Total discharge current (8/20) | | 10 kA |
| Total discharge current (10/350) | | D1: 2 kA |
| Protection level wire-wire | | < 95 V |
| Protection level wire-earth | | < 800 V |
| Frequency range | | 0-100 MHz |
| Temperature range | ϑ | -40 - +80 °C |
| Installation type | | DIN rail |
| Connection system | | Terminal |
| Protection rating | | IP20 |
| Shielding connection available | | Yes |
| Shield connection | | Direct |
| Connection cross-section, flexible | | 0.14 - 2.5 mm ² |
| Connection cross-section, multi-wire | | 0.14 - 1.5 mm ² |
| Connection cross-section, rigid | | 0.14 - 2.5 mm ² |
| Earthing via: | | DIN rail |
| EX approval | | II 2(1)G Ex ia [ja Ga] IIC T4 Gb |
| Testing standard | | IEC 61643-21 |
| Approvals | | UL |

Petrol Field Protector FDB

MCR protection for explosive areas

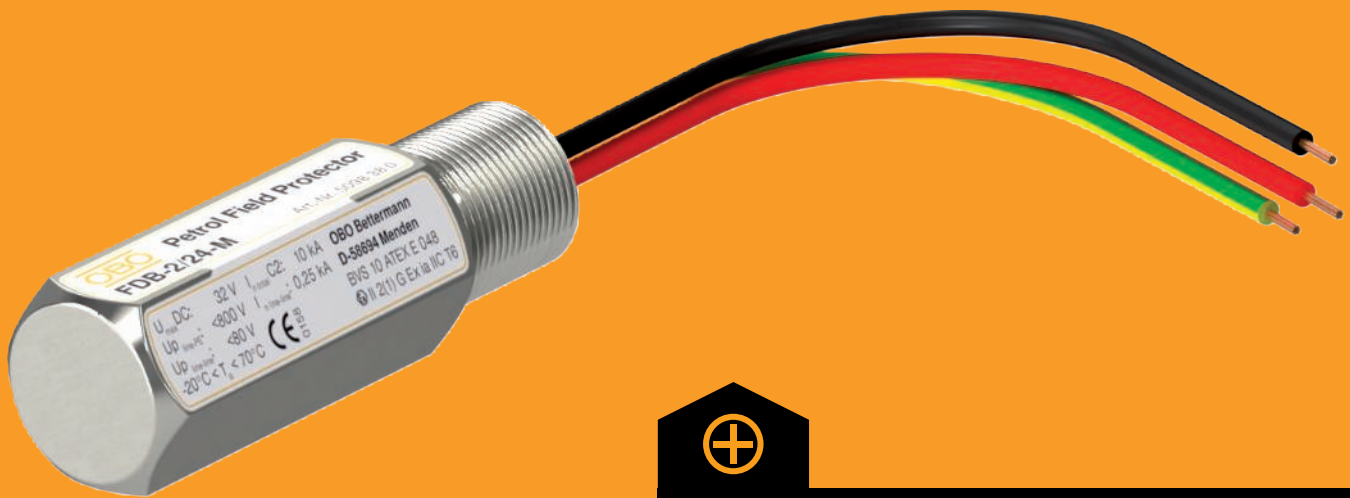

- For potentially explosive areas
- Two or three-pole protection of various sensors
- Metric or NPT thread
- Robust VA housing
- High arresting capacity

With the Petrol Field Protector for data cable protection devices, OBO Bettermann can offer a surge protective device for sensors in potentially explosive areas. The Petrol Field Protector permits two or three-pole protection of all kinds of sensors. The protection device can be fastened directly on the sensor and wired in using the appropriate metric or

NPT thread. The robust VA housing means that aggressive atmospheres are no problem. The intrinsic safety of the Petrol Field Protector has been independently tested and certified. The Petrol Field Protector is your partner for safety-relevant applications in which effective surge protection must be guaranteed.



Protection for field devices, 2-pole, 24 V, metric

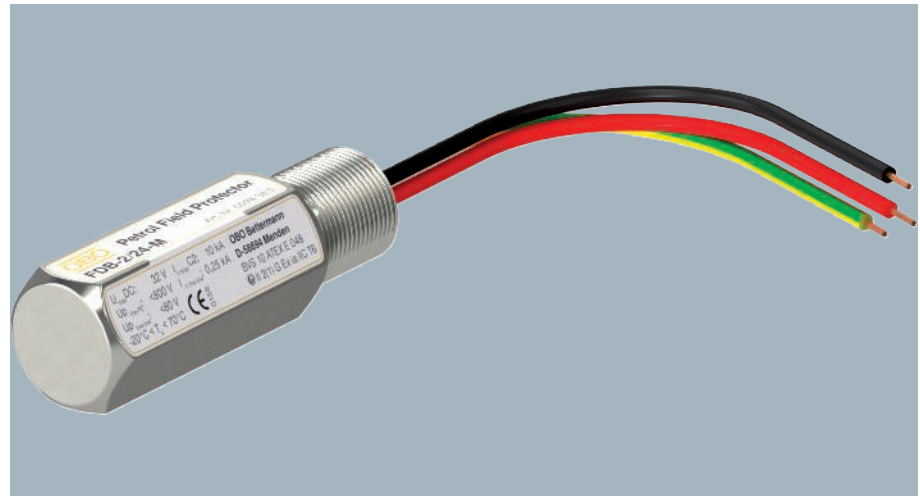
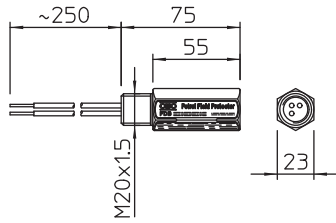

Petrol Field Protector FDB for intrinsically safe measuring circuits and bus systems

- Metric connection technology
- Low protection level at high current load
- Easy mounting on field devices
- Negligible internal capacitance and inductance
- Stainless steel housing with pressure-resistant encapsulation
- ATEX approval: II 2(1) G Ex ia [ja Ga] IIC T4..T6 Gb (BVS 10 ATEX E 048)

Application: Flow sensors, temperature sensors

| Type | Max. continuous voltage AC V | Max. continuous voltage DC V | Version | Pack Piece | Weight kg/100 pc. | Item no. |
|----------|------------------------------|------------------------------|----------------|------------|-------------------|----------|
| FDB-24-M | 22 | 32 | 2-pole; metric | 1 | 18.500 | 5098380 |

Connection options

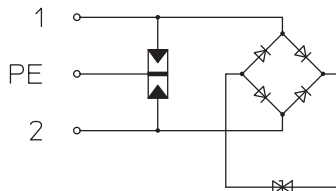

| FDB-24-M | |
|----------------------------------|--|
| Maximum continuous voltage AC | U_c 22 V |
| Maximum continuous voltage DC | U_c 32 V |
| Category | Type 2+3 / C2+C1 |
| Lightning protection zone LPZ | 1-3 |
| Number of poles | 2 |
| Impulse durability wire-wire | C1: 0,5 kV / 0,25 kA (8/20 μ s) |
| Impulse durability wire-earth | C2: 5 kV / 2,5 kA (8/20 μ s) |
| Total discharge current (8/20) | 10 kA |
| Protection level wire-wire | <80 V |
| Protection level wire-earth | <800 V |
| Temperature range | ϑ -20 - +70 °C |
| Installation type | Screw-on |
| Protection rating | IP65/67 |
| Mounting of input / output | M20 x 1.5 external thread |
| Mounting of field / device side: | Connection cable 1.5 mm ² Length ~ 250 mm |
| Earthing via: | Connection cable |
| Housing material | V2A |
| EX approval | II 2(1)G Ex ia [ja Ga] IIC T4..T6 Gb (BVS 10 ATEX E 048) |
| Testing standard | IEC 61643-21 |

Protection for field devices, 3-pole, 24 V, metric

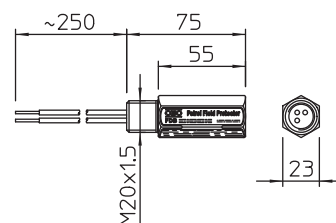
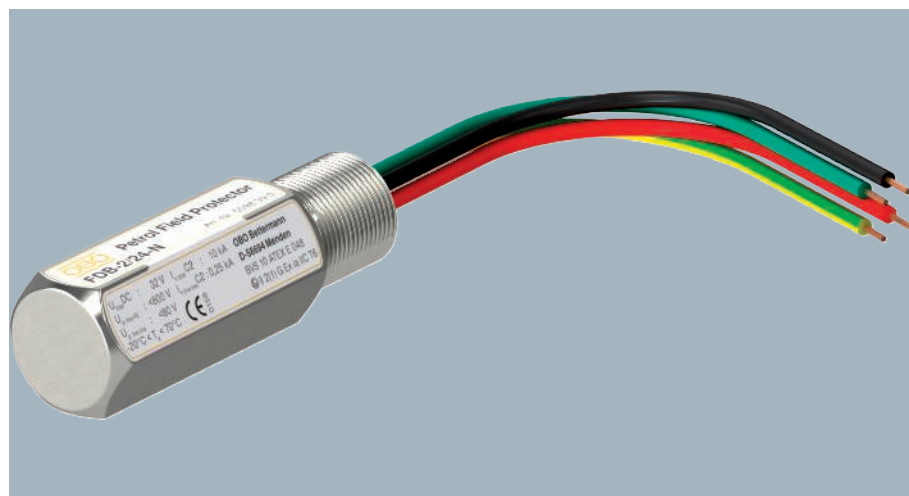

| Type | Max. continuous voltage AC V | Max. continuous voltage DC V | Version | Pack Piece | Weight kg/100 pc. | Item no. |
|------------|------------------------------|------------------------------|----------------|------------|-------------------|----------|
| FDB-3 24-M | 22 | 32 | 3-pole; metric | 1 | 19.000 | 5098382 |

Petrol Field Protector FDB for intrinsically safe measuring circuits and bus systems

- Metric connection technology
- Low protection level at high current load
- Easy mounting on field devices
- Negligible internal capacitance and inductance
- Stainless steel housing with pressure-resistant encapsulation
- ATEX approval: II 2(1) G Ex ia [ia Ga] IIC T4..T6 Gb (BVS 10 ATEX E 048)

Application: Flow sensors, temperature sensors

| FDB-3 24-M | |
|----------------------------------|--|
| Maximum continuous voltage AC | U_c 22 V |
| Maximum continuous voltage DC | U_c 32 V |
| Category | Type 2+3 / C2+C1 |
| Lightning protection zone LPZ | 1→3 |
| Number of poles | 3 |
| Impulse durability wire-wire | C1: 0,5 kV / 0,25 kA (8/20 μ s) |
| Impulse durability wire-earth | C2: 5 kV / 2,5 kA (8/20 μ s) |
| Total discharge current (8/20) | 10 kA |
| Protection level wire-wire | <80 V |
| Protection level wire-earth | <800 V |
| Temperature range | ϑ -20 - +70 °C |
| Installation type | Screw-on |
| Protection rating | IP65/67 |
| Mounting of input / output | M20 x 1.5 external thread |
| Mounting of field / device side: | Connection cable 1.5 mm ² Length ~ 250 mm |
| Earthing via: | Connection cable |
| Housing material | V2A |
| EX approval | II 2(1)G Ex ia [ia Ga] IIC T4..T6 Gb (BVS 10 ATEX E 048) |
| Testing standard | IEC 61643-21 |

Connection options

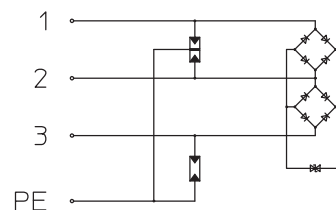



Protection for field devices, 2-pole, 24 V, NPT

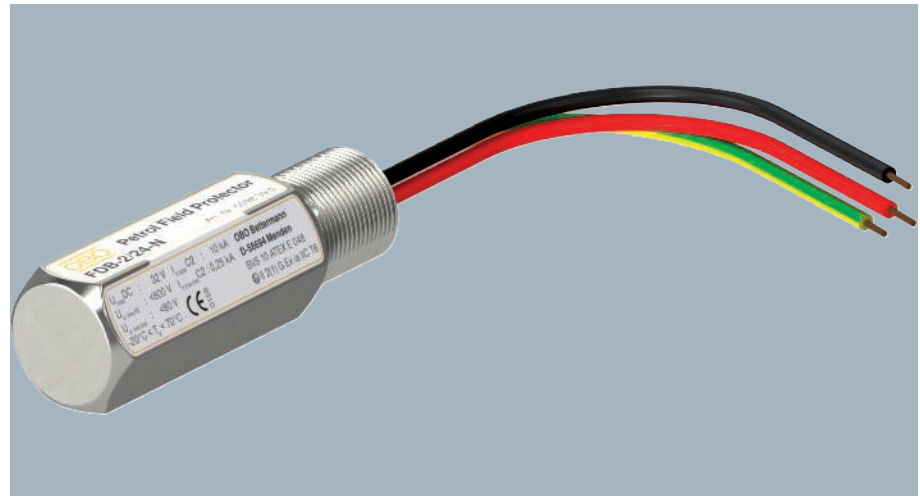
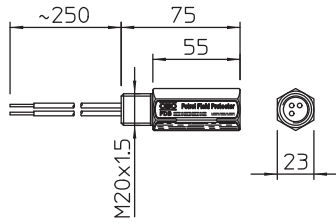

Petrol Field Protector FDB for intrinsically safe measuring circuits and bus systems

- NPT connection technology
- Low protection level at high current load
- Easy mounting on field devices
- Negligible internal capacitance and inductance
- Stainless steel housing with pressure-resistant encapsulation
- ATEX approval: II 2(1) G Ex ia [ja Ga] IIC T4..T6 Gb (BVS 10 ATEX E 048)

Application: Flow sensors, temperature sensors

| Type | Max. continuous voltage AC V | Max. continuous voltage DC V | Version | Pack Piece | Weight kg/100 pc. | Item no. |
|------------|------------------------------|------------------------------|-------------|------------|-------------------|----------|
| FDB-2 24-N | 22 | 32 | 2-pole; NPT | 1 | 19.000 | 5098390 |

Connection options

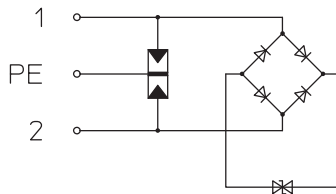

FDB-2 24-N

| | | |
|----------------------------------|-------------|--|
| Maximum continuous voltage AC | U_c | 22 V |
| Maximum continuous voltage DC | U_c | 32 V |
| Category | | Type 2+3 / C2+C1 |
| Lightning protection zone LPZ | | 1-3 |
| Number of poles | | 2 |
| Impulse durability wire-wire | | C1: 0,5 kV / 0,25 kA (8/20 μ s) |
| Impulse durability wire-earth | | C2: 5 kV / 2,5 kA (8/20 μ s) |
| Total discharge current (8/20) | | 10 kA |
| Protection level wire-wire | | <80 V |
| Protection level wire-earth | | <800 V |
| Temperature range | ϑ | -20 - +70 °C |
| Installation type | | Screw-on |
| Protection rating | | IP65/67 |
| Mounting of input / output | | 1/2" NPT |
| Mounting of field / device side: | | Connection cable 1.5 mm ² Length ~ 250 mm |
| Earthing via: | | Connection cable |
| Housing material | | V2A |
| EX approval | | II 2(1)G Ex ia [ja Ga] IIC T4..T6 Gb (BVS 10 ATEX E 048) |
| Testing standard | | IEC 61643-21 |

Protection for field devices, 3-pole, 24 V, NPT

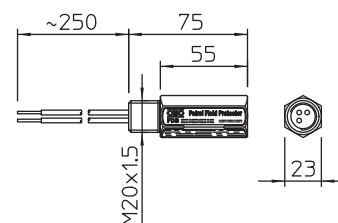
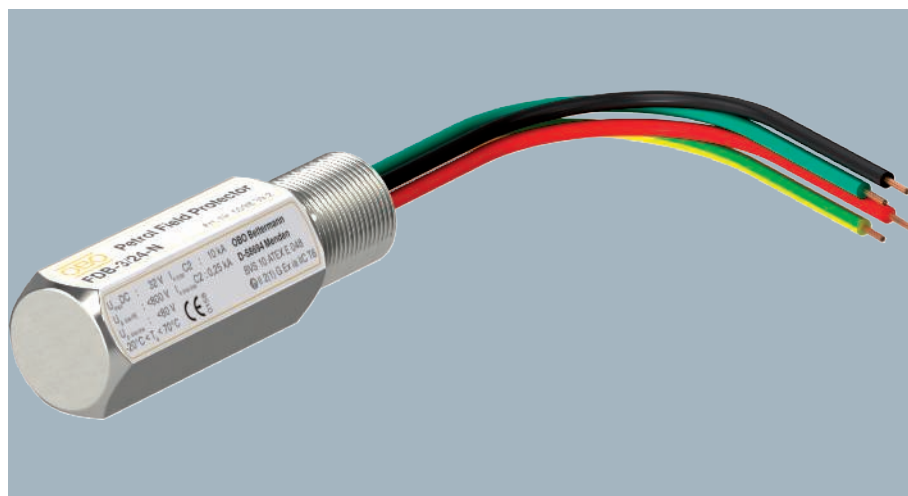

| Type | Max. continuous voltage AC V | Max. continuous voltage DC V | Version | Pack Piece | Weight kg/100 pc. | Item no. |
|------------|------------------------------|------------------------------|-------------|------------|-------------------|----------|
| FDB-3 24-N | 22 | 32 | 3-pole; NPT | 1 | 19.500 | 5098392 |

Petrol Field Protector FDB for intrinsically safe measuring circuits and bus systems

- NPT connection technology
- Low protection level at high current load
- Easy mounting on field devices
- Negligible internal capacitance and inductance
- Stainless steel housing with pressure-resistant encapsulation
- ATEX approval: II 2(1) G Ex ia [ia Ga] IIC T4..T6 Gb (BVS 10 ATEX E 048)

Application: Flow sensors, temperature sensors

| FDB-3 24-N | |
|----------------------------------|--|
| Maximum continuous voltage AC | U_c 22 V |
| Maximum continuous voltage DC | U_c 32 V |
| Category | Type 2+3 / C2+C1 |
| Lightning protection zone LPZ | 1-3 |
| Number of poles | 3 |
| Impulse durability wire-wire | C1: 0,5 kV / 0,25 kA (8/20 μ s) |
| Impulse durability wire-earth | C2: 5 kV / 2,5 kA (8/20 μ s) |
| Total discharge current (8/20) | 10 kA |
| Protection level wire-wire | <80 V |
| Protection level wire-earth | <800 V |
| Temperature range | ϑ -20 - +70 °C |
| Installation type | Screw-on |
| Protection rating | IP65/67 |
| Mounting of input / output | 1/2" NPT |
| Mounting of field / device side: | Connection cable 1.5 mm ² Length ~ 250 mm |
| Earthing via: | Connection cable |
| Housing material | V2A |
| EX approval | II 2(1)G Ex ia [ia Ga] IIC T4..T6 Gb (BVS 10 ATEX E 048) |
| Testing standard | IEC 61643-21 |

Connection options

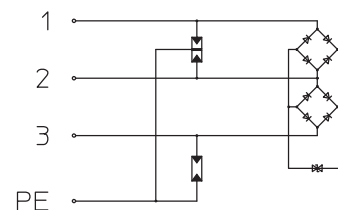



EX ISG H spark gap

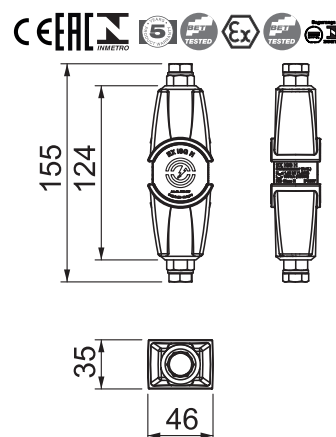

| Type | Pack Piece | Weight kg/100 pc. | Item no. |
|----------|------------|-------------------|----------|
| EX ISG H | 1 | 41.360 | 5240030 |

- Spark gap to VDE 0185-561-3 (IEC 62561-3)
- Ex certificate to ATEX
- Labelling to EN 60079-0/-1: II 2 G Ex db IIC T6 Gb
- Labelling to EN 60079-0/-31: II 2 D Ex td IIC T80 °C Db IP67
- Ex certificate to IECEx
- Labelling to IEC 60079-0/-1: Ex db IIC T6 Gb
- Labelling to IEC 60079-0/-31: Ex td IIC T80 °C Db IP67
- Ex certificate to INMETRO
- Labelling to ABNT NBR IEC 60079-0/-1: Ex db IIC T6 Gb
- Labelling to ABNT NBR IEC 60079-31: Ex td IIC T80 °C Db IP67

Application: In potentially explosive areas zone 1/21 and 2/22, indirect bridging of insulating flanges and insulating glands, e.g. in cathodic, corrosion-protected (KKS) systems.

| EX ISG H | | |
|---|-------------|--------------|
| Connecting cable length | | 0 m |
| Rated impulse sparkover voltage | $U_{r,imp}$ | 1.25 kV |
| Rated DC withstand voltage | U_{wDC} | 354 V |
| Rated power frequency withstand voltage | U_{wAC} | 250 V |
| Power frequency spark-over voltage | U_{AS} | 0.56 kV |
| Impulse discharge current (10/350) | I_{imp} | 100 kA |
| Nominal discharge current (8/20) | I_n | 100 kA |
| Lightning current carrying capacity | | H/100 kA |
| Temperature range | ϑ | -20 - +60 °C |

Connection options

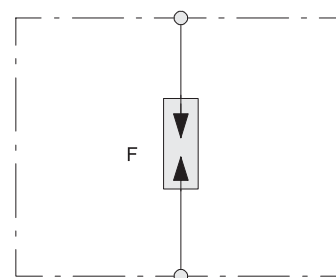

ES ISG H spark gap, with one cable

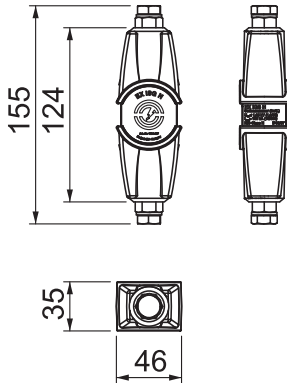

- Spark gap to VDE 0185-561-3 (IEC 62561-3)
- Ex certificate to ATEX
- Labelling to EN 60079-0/-1: II 2 G Ex db IIC T6 Gb
- Labelling to EN 60079-0/-31: II 2 D Ex td IIIC T80 °C Db IP67
- Ex certificate to IECEx
- Labelling to IEC 60079-0/-1: Ex db IIC T6 Gb
- Labelling to IEC 60079-0/-31: Ex td IIIC T80 °C Db IP67
- Ex certificate to INMETRO
- Labelling to ABNT NBR IEC 60079-0/-1: Ex db IIC T6 Gb
- Labelling to ABNT NBR IEC 60079-31: Ex td IIIC T80 °C Db IP67

Application: In potentially explosive areas zone 1/21 and 2/22, indirect bridging of insulating flanges and insulating glands, e.g. in cathodic, corrosion-protected (KKS) systems.

| Type | Pack Piece | Weight kg/100 pc. | Item no. |
|--------------|------------|-------------------|----------|
| EX ISG H 350 | 1 | 57.260 | 5240031 |

Connection options

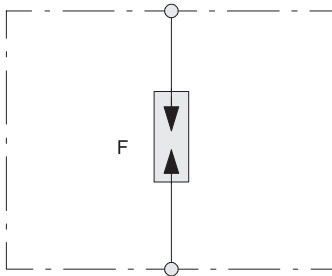

| EX ISG H 350 | | |
|---|---------------------|--------------|
| Connecting cable length | | 0.35 m |
| Rated impulse sparkover voltage | $U_{f \text{ imp}}$ | 1.25 kV |
| Rated DC withstand voltage | U_{wDC} | 354 V |
| Rated power frequency withstand voltage | U_{wAC} | 250 V |
| Power frequency spark-over voltage | U_{AS} | 0.56 kV |
| Impulse discharge current (10/350) | I_{imp} | 100 kA |
| Nominal discharge current (8/20) | I_n | 100 kA |
| Lightning current carrying capacity | | H/100 kA |
| Temperature range | ϑ | -20 - +60 °C |

Connection components

Cu

Connection cable – AL EX ISG

| Type | Dimension mm | Pack Piece | Weight kg/100 pc. | Item no. |
|---------------|--------------|------------|-------------------|----------|
| AL EX ISG 100 | 100 | 1 | 9.600 | 5240102 |
| AL EX ISG 200 | 200 | 1 | 12.300 | 5240104 |
| AL EX ISG 300 | 300 | 1 | 15.200 | 5240106 |

UV-resistant connection cable (copper 25 mm²) for mounting the OBO Ex spark gap, type EX ISG, on insulating flanges and insulating pieces. With cable shoe for M10 bolts on both sides, on one side with M10 screw, nuts and spring ring.

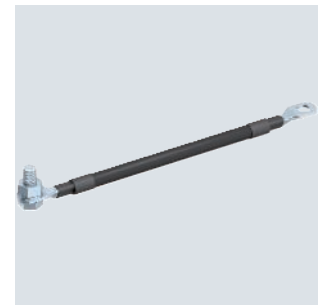

Connection clamp AB EX ISG straight

St FT

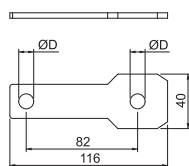

| Type | Drill hole | | Pack Piece | Weight kg/100 pc. | Item no. |
|-----------------|------------|--------------|------------|-------------------|----------|
| | Ø mm | Version | | | |
| AB EX ISG S M10 | 11 | For M10 bolt | 2 | 9.000 | 5240360 |
| AB EX ISG S M12 | 14 | For M12 bolt | 2 | 8.900 | 5240362 |
| AB EX ISG S M16 | 18 | For M16 bolt | 2 | 8.600 | 5240366 |
| AB EX ISG S M20 | 22 | For M20 bolt | 2 | 8.200 | 5240370 |
| AB EX ISG S M24 | 26 | For M24 bolt | 2 | 7.800 | 5240374 |

Connection clamp for mounting the OBO Ex spark gap, type EX ISG, on insulating flanges and insulating pieces.

Connection clamp AB EX ISG, angled

St FT

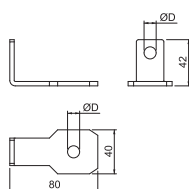

| Type | Drill hole | | Pack Piece | Weight kg/100 pc. | Item no. |
|------------------|------------|--------------|------------|-------------------|----------|
| | Ø mm | Version | | | |
| AB EX ISG SW M10 | 11 | For M10 bolt | 2 | 10.900 | 5240380 |
| AB EX ISG SW M12 | 14 | For M12 bolt | 2 | 10.800 | 5240382 |
| AB EX ISG SW M16 | 18 | For M16 bolt | 2 | 10.500 | 5240386 |
| AB EX ISG SW M20 | 22 | For M20 bolt | 2 | 10.100 | 5240390 |
| AB EX ISG SW M24 | 26 | For M24 bolt | 2 | 9.700 | 5240394 |

Connection clamp for mounting the OBO Ex spark gap, type EX ISG, on insulating flanges and insulating pieces.

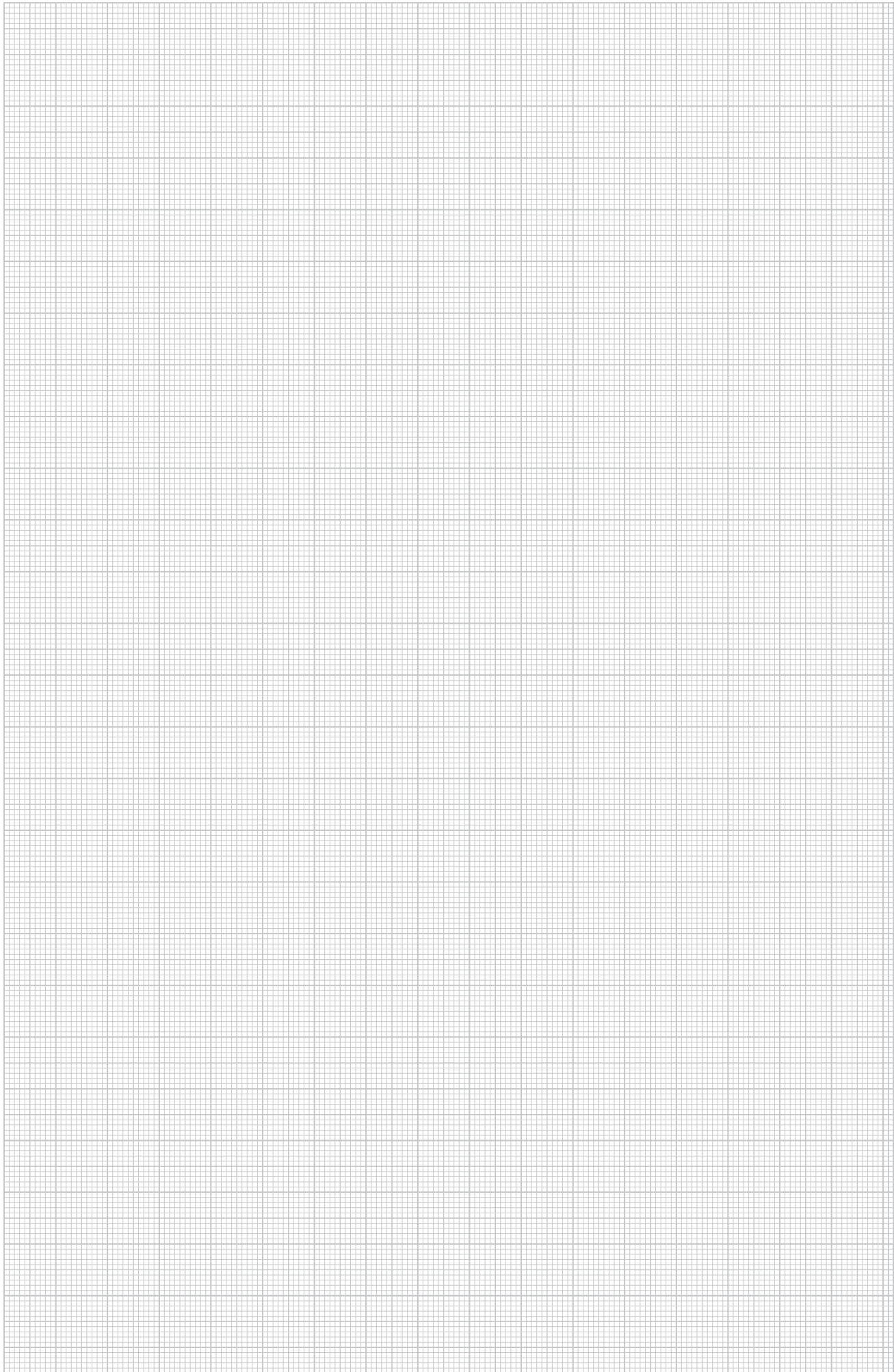

Safe together

The EX BES earthing pipe clamp augments the OBO portfolio for equipotential bonding in potentially explosive areas



Ignition spark-free lightning protection equipotential bonding – indoor and outdoor application

The earthing pipe clamp for Ex areas augments the OBO portfolio for equipotential bonding in potentially explosive areas. Like the EX BES, the EX PAS equipotential busbar has been independently tested in compliance with VDE 0185-561-1 (EN / IEC 62561-1) and independently certified for every explosion group in Ex zones 1/21 and 2/22.

- For pipes of 6–500 mm outer diameter
- UV-stabilised and halogen-free plastic hood
- Screws prevented from loosening as defined in VDE 0185-305-3 Supplement 2
- Suitable for indoor and outdoor applications



VA

Equipotential busbar for EX zone 1/21, 2/22

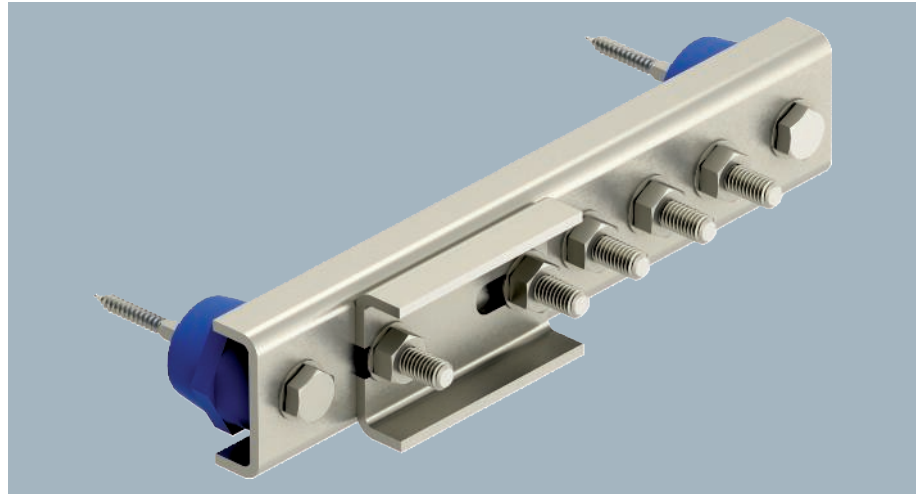

For ignition spark-free protection/functional equipotential bonding to DIN VDE 0100-410/-540 as well as ignition spark-free lightning protection equipotential bonding to VDE 0185-305 (IEC 62305) in systems to VDE 0165-1 (IEC/ EN 60079-14)

- Use in potentially explosive areas, Ex zone 1 and 2/21 and 22
- Tested according to explosion group IIC
- Lightning current carrying capacity class H (100 kA) to VDE 0185-561-1 (IEC/EN 62561-1)
- UV-stabilised and halogen-free insulation feet
- With spring washer for locking screws against self-loosening to VDE 0185-305-3 Supplementary sheet 2
- Suitable for indoor and outdoor applications

| Type | Number of connections | Lightning current carrying capacity kA | Pack Piece | Weight kg/100 pc. | Item no. |
|----------|-----------------------|--|------------|-------------------|----------|
| EX PAS 5 | 5 | H/100 | 1 | 152.000 | 5015265 |

VA

Equipotential busbar for EX zone 1/21, 2/22

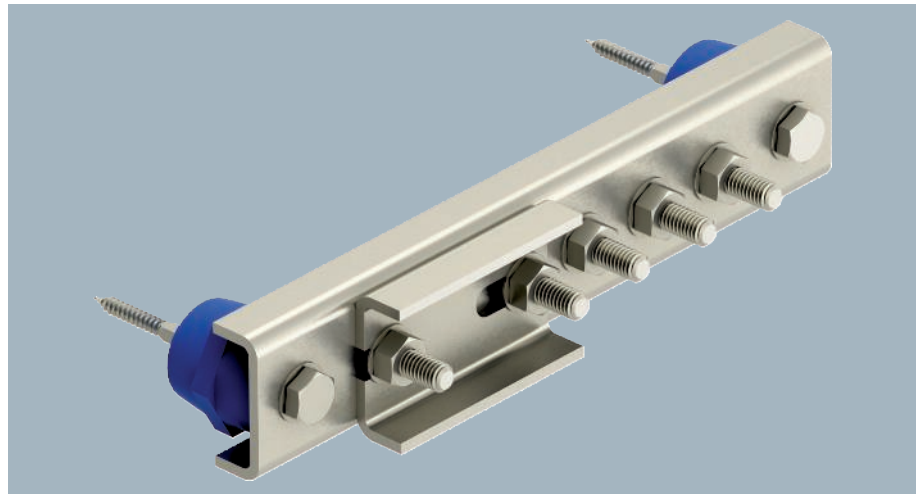

For ignition spark-free protection/functional equipotential bonding to DIN VDE 0100-410/-540 as well as ignition spark-free lightning protection equipotential bonding to VDE 0185-305 (IEC 62305) in systems to VDE 0165-1 (IEC/ EN 60079-14)

- Use in potentially explosive areas, Ex zone 1 and 2/21 and 22
- Tested according to explosion group IIC
- Lightning current carrying capacity class H (100 kA) to VDE 0185-561-1 (IEC/EN 62561-1)
- UV-stabilised and halogen-free insulation feet
- With spring washer for locking screws against self-loosening to VDE 0185-305-3 Supplementary sheet 2
- Suitable for indoor and outdoor applications

| Type | Number of connections | Lightning current carrying capacity kA | Pack Piece | Weight kg/100 pc. | Item no. |
|-----------|-----------------------|--|------------|-------------------|----------|
| EX PAS 10 | 10 | H/100 | 1 | 214.000 | 5015270 |



Earthing pipe clamp for EX Zone 1/21, 2/22

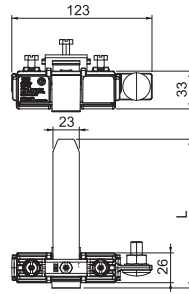
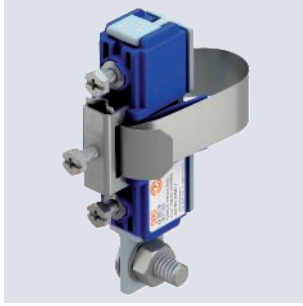

| Type | For pipe Ø mm | Dim. L mm | Lightning current carrying capacity kA | Pack Piece | Weight kg/100 pc. | Item no. |
|------------|---------------|-----------|--|------------|-------------------|----------|
| EX BES 28 | 6-28 | 215 | H/100 | 1 | 30.580 | 5057630 |
| EX BES 300 | 28-300 | 1170 | H/100 | 1 | 35.800 | 5057640 |
| EX BES 500 | 300-500 | 1800 | H/100 | 1 | 39.430 | 5057645 |

For ignition spark-free protection/functional equipotential bonding according to DIN VDE 0100-410/-540 and ignition spark-free lightning protection equipotential bonding according to VDE 0185-305 (IEC 62305) in systems according to VDE 0165-1 (IEC/EN 60079-14).

- For pipes of 6–500 mm external diameter
- Use in potentially explosive areas, Ex zone 1 and 2/21 and 22
- Tested according to explosion group IIC
- Lightning current carrying capacity class H (100 kA) to VDE 0185-561-1 (IEC/EN 62561-1)
- UV-stabilised and halogen-free plastic hood
- Secured with bolts against self-loosening to VDE 0185-305-3, Supplementary Sheet 2
- Suitable for indoor and outdoor applications

Tool

VA

Pre-tensioning tool

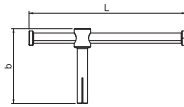

| Type | Dim. L mm | Dim. b mm | Pack Piece | Weight kg/100 pc. | Item no. |
|----------------|-----------|-----------|------------|-------------------|----------|
| 927 BES VSW 25 | 153 | 73 | 1 | 14.700 | 5057690 |

To tension earthing pipes and earthing pipe clamps.



isCon® conductor, Professional plus light grey

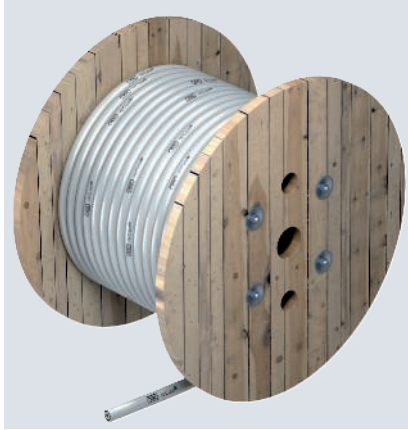

| Type | Cross-section mm ² | Nominal size Ø mm | Equivalent separation distance m | Pack m | Weight kg/100 m | Item no. |
|------------------|-------------------------------|-------------------|----------------------------------|--------|-----------------|----------|
| isCon Pro+ 75 GR | 35 | 26 | 0.75 | 25 | 86.800 | 5407995 |
| isCon Pro+ 75 GR | 35 | 26 | 0.75 | 100 | 86.800 | 5407997 |

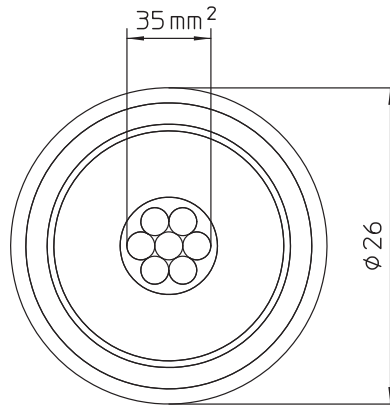

Please refer to the mounting instructions for information on routing the OBO isCon® conductor.

- Highly voltage-resistant, insulated arrester
- Protection against contact voltage during rain (VDE 0432-1 (IEC/EN 60060-1))
- Floating discharge-free
- Additional mechanical protection (double protective jacket)
- For maintenance of the separation distance according to IEC 62305 (VDE 0185-305-3)
- Tested according to IEC/EN 62561-1 (VDE 0185-561-1) with H1/150 kA
- Equivalent separation distance $se \leq 0.75$ m (air) and $se \leq 1.5$ (solid material)
- Tested according to IEC TS 62561-8 (VDE V 0185-561-8)
- Halogen-free
- Fire load 5.1 kWh/m
- Protection against contact voltage under sprinkling (VDE 0432-1 (IEC/EN 60060-1))
- Can be used in potentially explosive areas Ex zone 1/2 and 21/22 when taking the current mounting instructions into account

isCon® conductor, Professional plus black

| Type | Cross-section mm ² | Nominal size Ø mm | Equivalent separation distance m | Pack m | Weight kg/100 m | Item no. |
|------------------|----------------------------------|-------------------------|---|-----------|--------------------|----------|
| isCon Pro+ 75 SW | 35 | 23 | 0.75 | 25 | 69.400 | 5408002 |
| isCon Pro+ 75 SW | 35 | 23 | 0.75 | 100 | 69.400 | 5408004 |
| isCon Pro+ 75 SW | 35 | 23 | 0.75 | 250 | 69.400 | 5408006 |

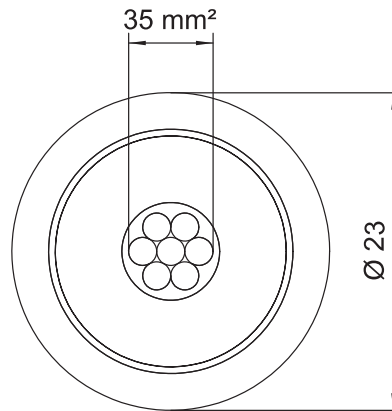

Please refer to the mounting instructions for information on routing the OBO isCon® conductor.

- Highly voltage-resistant, insulated conductor
- Floating discharge-free
- Additional mechanical protection (black protective jacket)
- For maintenance of the separation distance according to IEC 62305 (VDE 0185-305-3)
- Tested according to IEC/EN 62561-1 (VDE 0185-561-1) with H1/150 kA
- Equivalent separation distance $se \leq 0.75$ m (air) and $se \leq 1.5$ (solid material)
- Tested according to IEC TS 62561-8 (VDE V 0185-561-8)
- Halogen-free
- Fire load 4.3 kWh/m
- Can be used in potentially explosive areas Ex zone 1/2 and 21/22 when taking the current mounting instructions into account





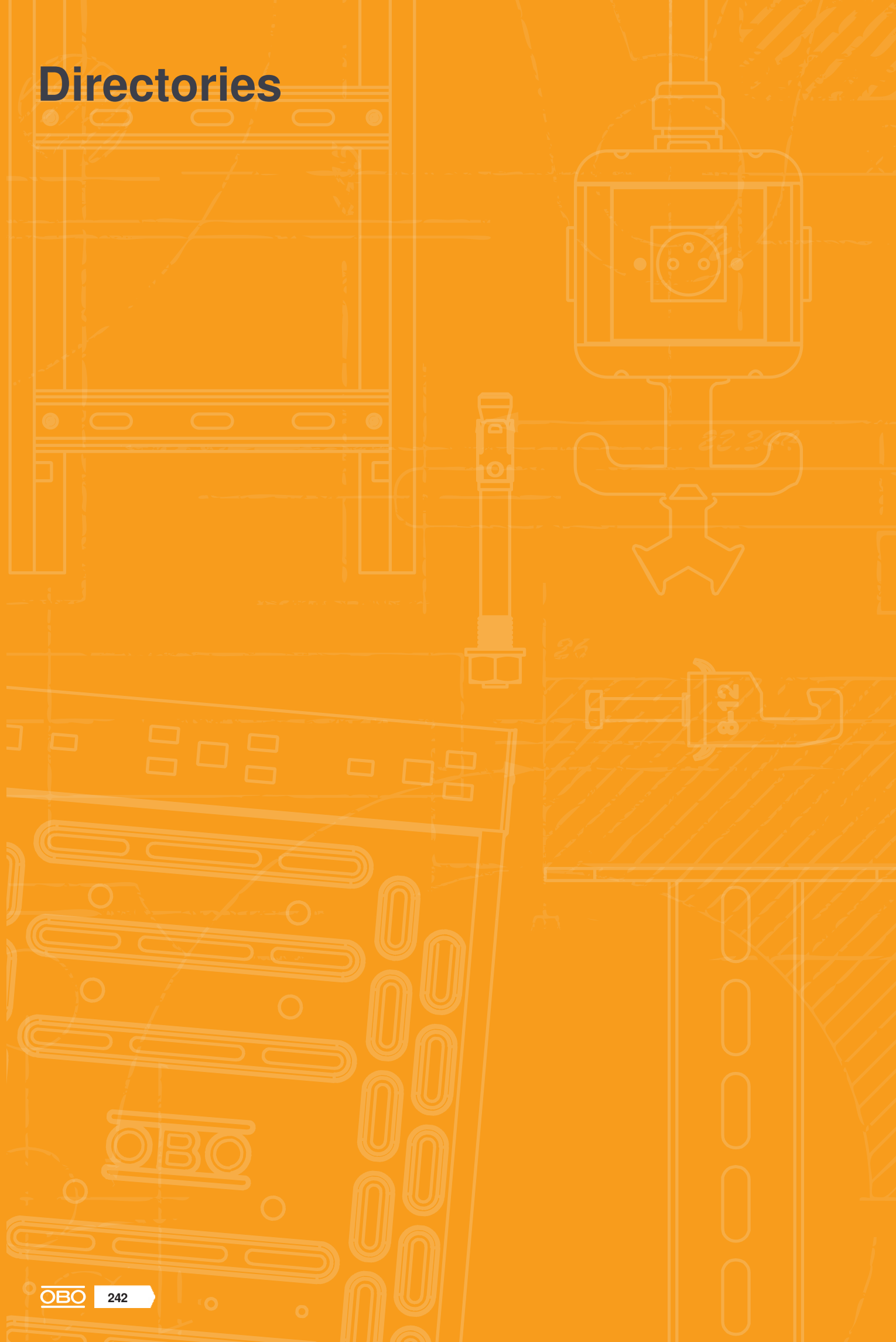

Directories



































Directories

| | | |
|---|-----------------------|-----|
|  | Test marks | 244 |
|  | Pictogram explanation | 246 |
|  | Numeric directory | 250 |



Test marks

| | | | |
|---|--|---|---|
|  | American Bureau of Shipping, USA |  | Underwriters Laboratories Inc., USA + CSA, Canada |
|  | AENOR, Producto Certificado, Spain |  | Österreichischer Verband für Elektrotechnik, Austria |
|  | STOWARZYSZENIE ELEKTRYKÓW POLSKICH, Poland |  | ISTITUTO ITALIANO DEL MARCHO DI QUALITÀ, Italy |
|  | Lightning current-tested |  | RINA 1861, Ship Classification, Certification and Services |
|  | Lightning current-tested, Class H (100 kA) |  | Underwriters Laboratories Inc., USA |
|  | CEBEC, Belgium |  | SEMKO An Inchcape Testing Services Company, Sweden |
|  | Canadian Standards Association, Canada |  | Eidgenössisches Starkstrominspektorat, Switzerland |
|  | DEMKO, Danmarks Elektriske Materielkontrol, Denmark |  | South African Bureau of Standards |
|  | Deutsches Institut für Bautechnik Berlin, Germany |  | Shock-tested, Bundesamt für Zivilschutz, Germany |
|  | Det Norske Veritas |  | Sähköarkastuskeskus Elinspektionscentralen Electrical Inspectorate, Finland |
|  | ENEC Austria |  | Underwriters Laboratories Inc., USA |
|  | ATEX certificate for explosive areas |  | Underwriters Laboratories Inc., USA |
|  | ELEKTROTECHNICKÝ ZKUŠEBNÍ ÚSTAV, Czech Republic |  | Verband der Elektrotechnik, Elektronik, Informationstechnik e.V., Germany |
|  | FIMKO, Finland |  | German Association of Electricians, tested safety |
|  | Forschungs- und Materialprüfungsanstalt, Germany |  | 5-year warranty |
|  | Russia, GOST The State Committee for Standards | | |
|  | Test marks for technical resources, VDE Prüf- und Zertifizierungsinstitut Offenbach, Germany | | |
|  | Halogen-free; without chlorine, fluorine and bromine | | |
|  | INMETRO, Brazil | | |
|  | KEMA-KEUR, Netherlands | | |
|  | Indication of metric products | | |
|  | MAGYAR ELEKTROTECHNIKAI ELLENŐRZŐ INTÉZET Budapest, Hungary | | |
|  | NEMKO, Norway | | |
|  | AFNOR Quality symbol of the French standardisation institute | | |



Pictogram explanation

Surfaces

| | |
|--------------|---|
| FS | Strip galvanised |
| FSK | Strip galvanised/plastic-coated |
| DD | Strip galvanised zinc/aluminium, double dip |
| BK | Bright |
| EL | Anodised |
| F | Hot-dip galvanised |
| G | Electrogalvanised |
| EI | Electrogalvanised/plastic-coated |
| GCL | Electrogalvanised, yellow-chromated |
| GGP | Electrogalvanised, yellow passivated |
| GTP | Electrogalvanised, transparently passivated |
| GR | Primed |
| L | Painted |
| SG | Welding primed |
| FT | Hot-dip galvanised |
| FT SO | Hot-dip galvanised 85 µm |
| Cu | Copper-plated |
| N | Nickel-plated |
| ZD | Galvanised, Deltatone 500 |
| ZDM | Galvanised, MAGNI 565 |
| GA | Zinc-aluminium coated, Galfan |
| ZL | Zinc scale |

Conformity symbol

| | |
|---------------------|--|
| CE | Communautés Européennes, EC declaration of conformity according to EC directives |
| RoHS conform | RoHS-conformant |

Quality marks

| | |
|---------------------|--|
| Halogen-free | Halogen-free; without chlorine, fluorine and bromine |
| 650 | Flame resistant 650 °C |
| 750 | Flame resistant 750 °C |
| 960 | Flame resistant 960 °C |
| UV resistant | UV-resistant |

Specific product symbols

| | |
|----------------|--|
| Ø 60 | Diameter 60 mm |
| Ø 68 | Diameter 68 mm |
| Type 3 | Protection device to DIN EN 61643-11 or IEC 61643-11 |
| LPZ 2→3 | Transition from LPZ 2 to LPZ 3 |
| AS | Acoustic signalling |

Applications



| | |
|-------------------------|--|
| FS | Remote signalling |
| AS | Acoustic signalling |
| ISDN | Integrated Service Digital Network, ISDN applications |
| DSL | Digital Subscriber Line, DSL applications |
| Analog TK | Analogue telecommunication |
| Cat 5 | Category 5 TwisterPair |
| Cat 6 | Channel Performance to American EIA/TIA standard |
| MSR | Measuring, controlling and regulating systems |
| TV | TV applications |
| SAT | SAT-TV applications |
| Mu | MultiBase base |
| LifeControl | LifeControl |
| EX | Intrinsically safe protection device for potentially explosive areas |
| Class E | Channel Performance to ISO / IEC 11801 |
| PoE | Power over Ethernet |
| 230/400 V System | 230/400 V system |
| IP 54 | Protection rating IP 54 |
| IP 65 | Protection rating IP 65 |

Lightning protection classes







| | |
|-----------------|---|
| Type 1 | Protection device to DIN EN 61643-11 or IEC 61643-11 |
| Type 1+2 | Combination protection device made of type 1 and type 2 |
| Type 2 | Protection device to DIN EN 61643-11 or IEC 61643-11 |







Lightning protection classes

| | |
|---|--|
|  | Protection device to DIN EN 61643-11 or IEC 61643-11 |
|  | Protection device to DIN EN 61643-11 or IEC 61643-11 |



Lightning protection zone

| | |
|---|--------------------------------|
|  | Transition from LPZ 0 to LPZ 1 |
|  | Transition from LPZ 0 to LPZ 2 |
|  | Transition from LPZ 0 to LPZ 3 |
|  | Transition from LPZ 1 to LPZ 2 |
|  | Transition from LPZ 1 to LPZ 3 |
|  | Transition from LPZ 2 to LPZ 3 |



BSS maintenance of electrical function installation

| | |
|---|--|
|  | Fire-tested systems |
|  | Escape route ceiling mounting with pressure clip |
|  | OBO Grip, wall routing type |
|  | OBO Grip, ceiling routing type |
|  | Pressure clip for maintenance of electrical function, ceiling mounting |



BSS anchor

| | |
|---|--------------------------|
|  | Fire protection anchor |
|  | Fire protection bolt tie |

BSS test marks/material class

| | |
|---|--|
|  | Maintenance of electrical function class E30 |
|  | Maintenance of electrical function class E90 |













Clamp clip base shapes

| | |
|---|--|
|  | Clamp clip for C profile rail, slot width 11–12 mm |
|  | Clamp clip for C profile rail, slot width 16–17 mm |
|  | Clamp clip for C profile rail, slot width 18–22 mm |



Diameter

| | |
|---|----------------|
|  | Diameter 60 mm |
|  | Diameter 68 mm |
|  | Diameter 70 mm |
|  | Diameter 74 mm |





Entries

| | |
|--|----------------------|
|  | 4 cable entries |
|  | 6 cable entries |
|  | 7 cable entries |
|  | 8 cable entries |
|  | 9 cable entries |
|  | 10 cable entries |
|  | 12 cable entries |
|  | 10 cable entries ECO |
|  | 12 cable entries ECO |
|  | 14 cable entries ECO |
|  | 16 cable entries |
|  | 18 cable entries ECO |
|  | 24 cable entries |





Gland thread

| | |
|---|---------------|
|  | Thread metric |
|  | Thread Pg |





Entry size

| | |
|---|-----------|
|  | M20 entry |
|  | M25 entry |
|  | M32 entry |
|  | M40 entry |

KTS side heights

| | |
|---|-------------------------------------|
|  | Cable tray, side height 35 mm |
|  | Cable tray, side height 60 mm |
|  | Cable tray, side height 85 mm |
|  | Mesh cable tray, slant height 35 mm |
|  | Mesh cable tray, slant height 55 mm |









Materials

| | |
|---|----------------|
|  | Flat steel |
|  | Angular steel |
|  | U steel |
|  | Round material |





Pictogram explanation

Nominal cross-section

| | |
|---|---|
|  | Nominal cross-section 1.5 mm ² |
|  | Nominal cross-section 1.5–2.5 mm ² |
|  | Nominal cross-section 2.5 mm ² |
|  | Nominal cross-section 2.5–4 mm ² |
|  | Nominal cross-section 4 mm ² |
|  | Nominal cross-section 4–6 mm ² |
|  | Nominal cross-section 6 mm ² |
|  | Nominal cross-section 10 mm ² |
|  | Nominal cross-section 16 mm ² |











Nominal voltage

| | |
|---|-----------------------|
|  | Nominal voltage 400 V |
|  | Nominal voltage 500 V |
|  | Nominal voltage 660 V |





Polarity

| | |
|---|---------|
|  | 3-pole |
|  | 5-pole |
|  | 7-pole |
|  | 8-pole |
|  | 10-pole |
|  | 12-pole |



Slot widths

| | |
|---|---------------------|
|  | Slot width 7.5 mm |
|  | Slot width 11 mm |
|  | Slot width 11–12 mm |
|  | Slot width 12 mm |
|  | Slot width 15 mm |
|  | Slot width 16 mm |
|  | Slot width 16.5 mm |
|  | Slot width 16–17 mm |
|  | Slot width 17 mm |
|  | Slot width 18 mm |
|  | Slot width 22 mm |
|  | Slot width 35 mm |











Screw heads

| | |
|---|----------------|
|  | Philips screw |
|  | Torx screw |
|  | Phillips screw |
|  | Pozidrive |











Firing devices

| | |
|---|------------------|
|  | Bolt-firing tool |
|  | Nail device |





Protection rating

| | |
|---|-------------------------|
|  | Protection rating IP 20 |
|  | Protection rating IP 30 |
|  | Protection rating IP 31 |
|  | Protection rating IP 44 |
|  | Protection rating IP 54 |
|  | Protection rating IP 55 |
|  | Protection rating IP 65 |
|  | Protection rating IP 66 |
|  | Protection rating IP 67 |
|  | Protection rating IP 68 |

Metals

| | |
|---|----------------------------|
|  | Aluminium |
|  | Aluminium/steel |
|  | Stainless steel, rustproof |
|  | Stainless steel, rustproof |
|  | Stainless steel, rustproof |
|  | Copper |
|  | Brass |
|  | Steel |
|  | Malleable iron |
|  | Die-cast zinc |

Plastics

| | |
|---|-------------------------------------|
|  | Acrylonitrile butadiene styrene |
|  | Duroplast, Aminoplast, type 131.5 |
|  | Duroplast, melamine resin, type 150 |
|  | Ethylene vinyl acetate |



Plastics

| | |
|--------------------|---------------------------------------|
| FA | Fibre-proof material DIN 28091 |
| GFK | Fibre-glass-reinforced plastic |
| NBR SBR | Rubber mixture |
| NBR | Nitrile rubber |
| PETR | Petrolatum |
| PA | Polyamide |
| PA/ GF | Polyamide, fibre-glass reinforced |
| PBPT | Polybutylene terephthalate |
| PC | Polycarbonate |
| PE | Polyethylene |
| PP | Polypropylene |
| PP/GF | Polypropylene, fibre-glass reinforced |
| PS | Polystyrene |
| PVC | Polyvinylchloride |
| ZELL PE | Cellular polyethylene |



Numeric directory

| GTIN | Item no. | Page | GTIN | Item no. | Page | GTIN | Item no. | Page | GTIN | Item no. | Page |
|---------|----------------------------|------|---------|----------------|------|---------|----------------|------|---------|----------------|------|
| 6190386 | /100 pc. 5012010 | 216 | 6515400 | 5092431 | 74 | 5541158 | 5096849 | 27 | 5708902 | 5099611 | 207 |
| | /pc. | | 6515431 | 5092433 | 75 | 5051466 | 5096852 | 28 | 5708933 | 5099708 | 208 |
| 6427628 | 5015265 | 237 | 6426690 | 5092441 | 81 | 5541394 | 5096865 | 29 | | | |
| 6427680 | 5015270 | 237 | 5080886 | 5092451 | 80 | 5362029 | 5096874 | 70 | 6517381 | 5240030 | 232 |
| 6672813 | 5057630 | 238 | 5247098 | 5092460 | 83 | 5362036 | 5096875 | 69 | 6521180 | 5240031 | 233 |
| 6672820 | 5057640 | 238 | 5613596 | 5092472 | 82 | 5077077 | 5096877 | 30 | 6521159 | 5240102 | 233 |
| 6672837 | 5057645 | 238 | 5952817 | 5092701 | 92 | 5077091 | 5096879 | 32 | 6521166 | 5240104 | 233 |
| 6672844 | 5057690 | 238 | 5035053 | 5092800 | 87 | 5531135 | 5096884 | 216 | 6521173 | 5240106 | 233 |
| 6741908 | 5080301 | 132 | 5035114 | 5092808 | 89 | 5531197 | 5096886 | 216 | 6524181 | 5240360 | 234 |
| 6741915 | 5080303 | 132 | 5047223 | 5092812 | 90 | 6776368 | 5096900 | 218 | 6524242 | 5240362 | 234 |
| 6741922 | 5080305 | 132 | 5035176 | 5092816 | 86 | 6585588 | 5096950 | 13 | 6524259 | 5240366 | 234 |
| 6741939 | 5080307 | 132 | 5035237 | 5092824 | 88 | 6585595 | 5096953 | 14 | 6524273 | 5240370 | 234 |
| 6741946 | 5080309 | 133 | 5047254 | 5092828 | 91 | 6585564 | 5096961 | 15 | 6524297 | 5240374 | 234 |
| 6741953 | 5080311 | 133 | 5390671 | 5093015 | 160 | 6585571 | 5096963 | 16 | 6524433 | 5240380 | 234 |
| 6741960 | 5080313 | 133 | 5390732 | 5093023 | 159 | 6608805 | 5096971 | 17 | 6524457 | 5240382 | 234 |
| 6741977 | 5080315 | 133 | 5390732 | 5093023 | 159 | 6608812 | 5096973 | 18 | 6524464 | 5240386 | 234 |
| | | | 5030881 | 5093171 | 168 | | /pc. | | 6524471 | 5240390 | 234 |
| | | | 5390978 | 5093236 | 162 | 5990116 | 5096974 | 47 | 6524488 | 5240394 | 234 |
| | | | 5391036 | 5093252 | 161 | 6608782 | 5096975 | 19 | | | |
| | | | 5391098 | 5093260 | 163 | | /pc. | | | price/100 | |
| 6676965 | 5081070 | 155 | 5087250 | 5093270 | 167 | 5995012 | 5096976 | 48 | 5888123 | 5407995 | 240 |
| 6676972 | 5081072 | 156 | 5022619 | 5093272 | 170 | 6608799 | 5096977 | 20 | 5888154 | 5407997 | 240 |
| | /pc. | | 5022732 | 5093275 | 169 | | /pc. | | | | |
| 6034352 | 5081690 | 135 | 5867050 | 5093277 | 171 | 6487325 | 5096981 | 25 | 5674573 | 5408002 | 241 |
| 6087723 | 5081694 | 137 | 5076551 | 5093380 | 64 | 6608768 | 5096982 | 21 | 5674627 | 5408004 | 241 |
| 6427444 | 5081698 | 136 | 6098583 | 5093382 | 66 | 6608775 | 5096983 | 22 | 5854265 | 5408006 | 241 |
| 5614364 | 5081800 | 148 | 5299448 | 5093391 | 65 | 6608744 | 5096985 | 23 | | | |
| 6532766 | 5081802 | 149 | 6412952 | 5093500 | 35 | | /pc. | | | /pc. | |
| 6532773 | 5081804 | 150 | 6412969 | 5093502 | 37 | 6487332 | 5096987 | 26 | 6117611 | 6117465 | 85 |
| 6415656 | 5081975 | 140 | 6159598 | 5093508 | 215 | 6608751 | 5096988 | 24 | 6117673 | 6117473 | 84 |
| 6415663 | 5081977 | 139 | 6159604 | 5093511 | 40 | | /pc. | | | | |
| | | | 6159628 | 5093513 | 44 | 5995029 | 5096990 | 217 | | | |
| 5685333 | 5082382 | 154 | 6159642 | 5093516 | 41 | 5995036 | 5096992 | 217 | | | |
| 6415717 | 5082430 | 151 | 6159659 | 5093518 | 45 | 5995043 | 5096994 | 217 | | | |
| 6415724 | 5082432 | 152 | 6159666 | 5093522 | 36 | | | | | | |
| 6415731 | 5082434 | 153 | 6159680 | 5093524 | 39 | 5708896 | 5097065 | 206 | | | |
| | | | 6159697 | 5093526 | 42 | 5478683 | 5097447 | 179 | | | |
| 5022978 | 5083400 | 172 | 6159703 | 5093531 | 38 | 5709121 | 5097448 | 180 | | | |
| | | | 6159710 | 5093533 | 43 | 5578116 | 5097453 | 107 | | | |
| 5525134 | 5084008 | 143 | 6423217 | 5093594 | 67 | 5736561 | 5097454 | 113 | | | |
| 5525196 | 5084012 | 143 | 6423224 | 5093596 | 68 | 5578123 | 5097607 | 108 | | | |
| 5525257 | 5084016 | 144 | 5478546 | 5093623 | 181 | 5578130 | 5097615 | 109 | | | |
| 5525318 | 5084020 | 142 | 5709022 | 5093625 | 182 | 5578147 | 5097623 | 110 | | | |
| 5525370 | 5084024 | 142 | 5708841 | 5093726 | 205 | 5578154 | 5097631 | 111 | | | |
| 5525493 | 5084032 | 145 | 5962243 | 5093988 | 165 | 5578161 | 5097650 | 112 | | | |
| 5525554 | 5084036 | 145 | 5805991 | 5093996 | 164 | 5578185 | 5097820 | 114 | | | |
| 5525615 | 5084040 | 144 | 6463831 | 5093998 | 166 | 5812258 | 5097822 | 115 | | | |
| 5110750 | 5084048 | 146 | | | | 5578215 | 5097858 | 116 | | | |
| | | | 6603695 | 5094210 | 183 | 5578260 | 5097939 | 117 | | | |
| 6816095 | 5088554 | 203 | 6603701 | 5094212 | 184 | 5578277 | 5097976 | 97 | | | |
| 6816088 | 5088556 | 204 | 6603718 | 5094230 | 177 | | | | | | |
| | /pc. | | 6603725 | 5094232 | 178 | 5683339 | 5098380 | 227 | | | |
| 6440573 | 5088564 | 200 | 6603732 | 5094240 | 175 | 5683346 | 5098382 | 228 | | | |
| 6440580 | 5088565 | 201 | 6603749 | 5094242 | 176 | 5683384 | 5098390 | 229 | | | |
| 6190263 | 5088566 | 191 | 5648482 | 5094574 | 186 | 5683391 | 5098392 | 230 | | | |
| 6329854 | 5088568 | 192 | 5709084 | 5094576 | 188 | 5406839 | 5098404 | 119 | | | |
| 6037421 | 5088573 | 195 | 5708872 | 5094605 | 187 | 5406846 | 5098407 | 120 | | | |
| 6037476 | 5088579 | 193 | 5478621 | 5094608 | 185 | 5406853 | 5098411 | 121 | | | |
| 6037490 | 5088585 | 194 | | | | 5848516 | 5098412 | 223 | | | |
| 6423170 | 5088591 | 189 | 6159802 | 5095161 | 50 | 5625124 | 5098413 | 128 | | | |
| 6423187 | 5088593 | 190 | 6159819 | 5095162 | 54 | 5787372 | 5098415 | 129 | | | |
| 5872658 | 5088629 | 202 | 6159826 | 5095163 | 58 | 5773610 | 5098419 | 130 | | | |
| 5981176 | 5088635 | 199 | 6159833 | 5095164 | 62 | 5406860 | 5098422 | 122 | | | |
| 6422654 | 5088640 | 196 | 6161140 | 5095251 | 52 | 5787389 | 5098425 | 131 | | | |
| 5780717 | 5088651 | 197 | 6161324 | 5095252 | 56 | 5406877 | 5098427 | 123 | | | |
| 6148561 | 5088654 | 198 | 6161331 | 5095253 | 60 | 5406884 | 5098431 | 124 | | | |
| | | | 6162000 | 5095281 | 51 | 5848523 | 5098432 | 224 | | | |
| 5237341 | 5089650 | 216 | 6162185 | 5095282 | 55 | 5406891 | 5098442 | 125 | | | |
| 5709350 | 5089660 | 216 | 6162338 | 5095283 | 59 | 5406907 | 5098446 | 126 | | | |
| 5709367 | 5089662 | 216 | 6162819 | 5095284 | 63 | 5406914 | 5098450 | 127 | | | |
| | | | 6163014 | 5095331 | 53 | 5848530 | 5098452 | 225 | | | |
| | price/pac | | 6163243 | 5095332 | 57 | 5410461 | 5098470 | 218 | | | |
| 5461111 | 5091322 | 212 | 6163427 | 5095333 | 61 | 5813521 | 5098475 | 217 | | | |
| 5461296 | 5091438 | 212 | 6163557 | 5095364 | 215 | 5578307 | 5098514 | 98 | | | |
| 5461470 | 5091527 | 213 | 6423194 | 5095381 | 71 | 5578314 | 5098522 | 99 | | | |
| | /pc. | | 6423200 | 5095383 | 72 | 5578338 | 5098557 | 100 | | | |
| 5461654 | 5091683 | 212 | 6337620 | 5095609 | 214 | 5578345 | 5098571 | 95 | | | |
| 6465644 | 5091722 | 211 | | | | 5578352 | 5098575 | 96 | | | |
| | | | 5425182 | 5096786 | 211 | 5578369 | 5098600 | 101 | | | |
| 6426713 | 5092420 | 77 | 5921738 | 5096812 | 211 | 5578376 | 5098603 | 102 | | | |
| 6426720 | 5092422 | 76 | 5544517 | 5096822 | 214 | 5578383 | 5098611 | 103 | | | |
| 6426751 | 5092424 | 79 | 5288282 | 5096835 | 31 | 5578390 | 5098630 | 104 | | | |
| 6426768 | 5092426 | 78 | 5288299 | 5096836 | 33 | 5578413 | 5098646 | 105 | | | |



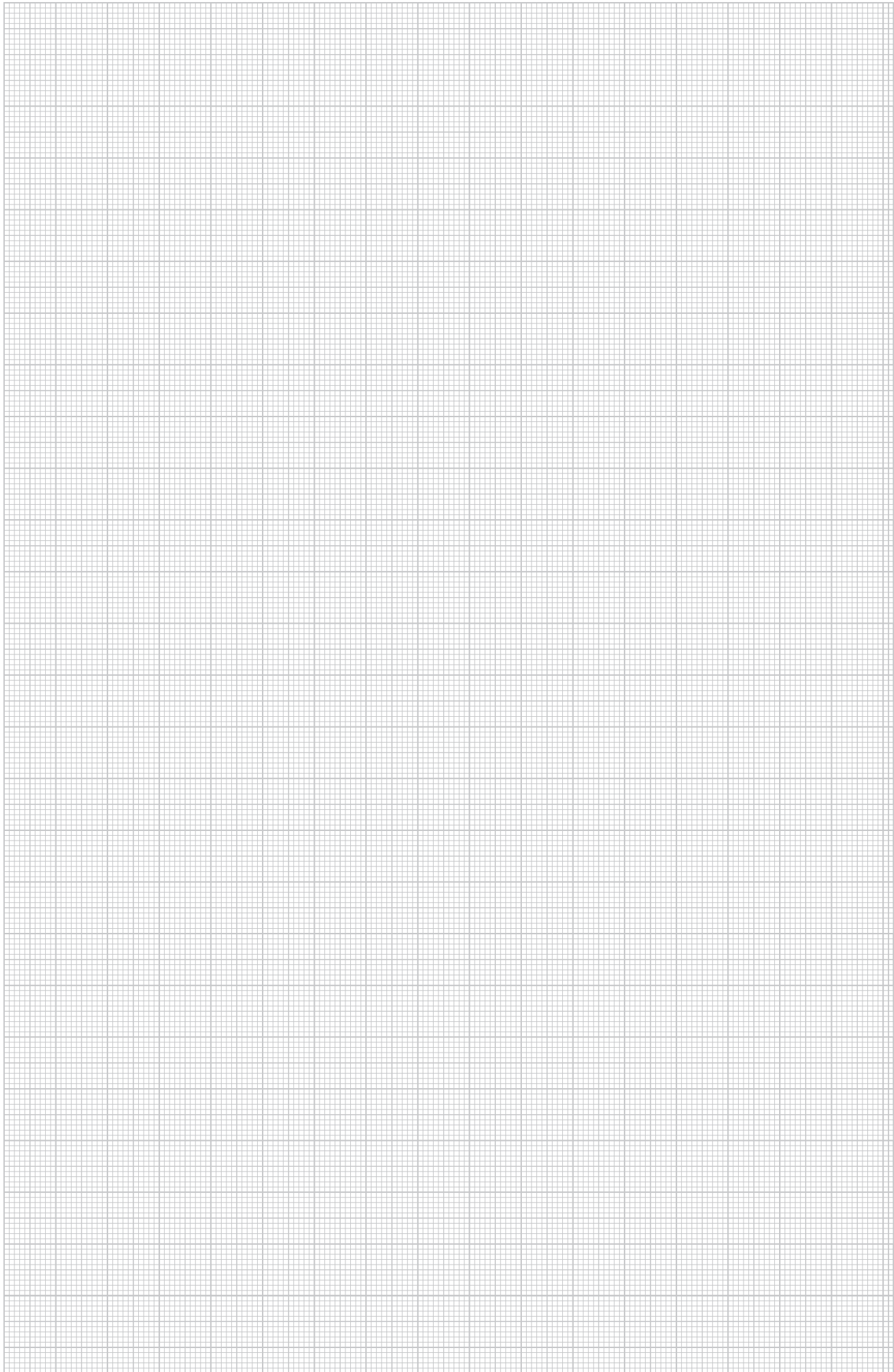

OBO Bettermann Holding GmbH Co. KG

P.O. Box 1120
58694 Menden, Germany

Customer Service

Tel.: +49 23 73 89 - 17 00
Fax: +49 23 73 89 - 12 38
export@obo.de

www.obo-bettermann.com

Building Connections

