



Building installations

Devices



Our products for your project Towards the future with OBO

Reliable, safe and of the highest quality: Product features such as installation speed, load capacity, functionality and availability are at the forefront of each of our innovations. Discover the whole range of OBO products – in a new structure, allowing us to deal in a more targeted manner with the needs of you, our customers.

It is our aim to be the first port of call for the best and most innovative connections for electrical and data technology infrastructure. Thus, when looking towards the future, we have asked ourselves what we can do to be the best possible partner you could ever imagine, also in the long term. Against this backdrop, we have optimised our structure once again, sharpened our profile and defined our services more clearly. The result: Three new areas of application, which replace our previous seven product units, in order to provide you with a contemporary and user-orientated visual identity and structure, for both products and communication. This helps you to find exactly the products you are looking for in an even faster and simpler manner.

In this catalogue, we will present the entire product variety of the Building installations application area to you. The Building installations area contains cable routing and underfloor systems for administrative and functional buildings including architectural solutions. To meet the wishes of you, our customers, as well as possible, we pay particular attention to top-class functionality during development, which also includes the highest design requirements.

This is how versatile, intelligent solutions are created, which can be used in all living spaces. Our systems transport power and data in a hidden way to the place where you need them. A large selection of device installation units and cable trunking gives you access to power, data and multimedia connections. The wide range of flexible application options thus creates an individual solution for each building.

OBO – simply better.

OBO Product Worlds



Building installations

- Electrical installation ducts and trunking
- Device installation ducts and trunking
- Skirting trunking
- Service poles
- Underfloor applications, in screed
- Underfloor applications, in concrete
- Underfloor applications, on-floor
- Service outlets for underfloor applications
- Floor sockets and floor boxes
- Installation housing and support
- Tabletop sockets
- Sockets, switches, data and multimedia technology

You can find additional products in our new Industrial and Protective installation catalogues



Industrial installations

Cable support systems and connection and fastening systems for industry and construction project infrastructure

- Cable trays
- Mesh cable trays
- Cable ladders
- Industrial ducts
- Support structures
- Electrical installation pipes
- Wiring ducts
- Power supply units
- Distributors
- Junction boxes
- Concealed and cavity wall installations
- Terminals
- Cable glands
- Installation and fastening clips
- Anchors and fastening systems



Safety and protection installations

Lightning, surge and fire protection systems

- Surge protection
- Explosion protection
- Lightning protection
- Earthing
- Equipotential bonding
- Insulation
- Cable bandages – prevention of the spread of fire
- Escape route installations – false ceiling mounting
- Fire protection ducts
- Systems for the maintenance of electrical functionality – cable-specific routing variants
- Systems for the maintenance of electrical functionality – standard support structures and routing systems
- Systems for the maintenance of electrical functionality – FireBox T series junction boxes
- Anchoring systems

Contents



**Connectable connection technology, Wieland
GST18, WAGO WINSTA**

Page 10



Sockets, switches, data and multimedia technology

Page 38



Tabletop sockets

Page 96



Directories

Page 108





**Welcome world.
Welcome to OBO.**

New solutions to improve functionality and the ease of installation – OBO employees all around the world use their abilities and creativity to make this happen. Because we know that each individual market has its special characteristics and that the requirements for our products change within each market, we have paid particular attention to the compatibility of products in their place of use. We always offer our customers intelligent, well-thought-out solutions. Our brands always keep this promise. The OBO global team wishes to make the work of electrical planners and operatives around the world as easy as possible.

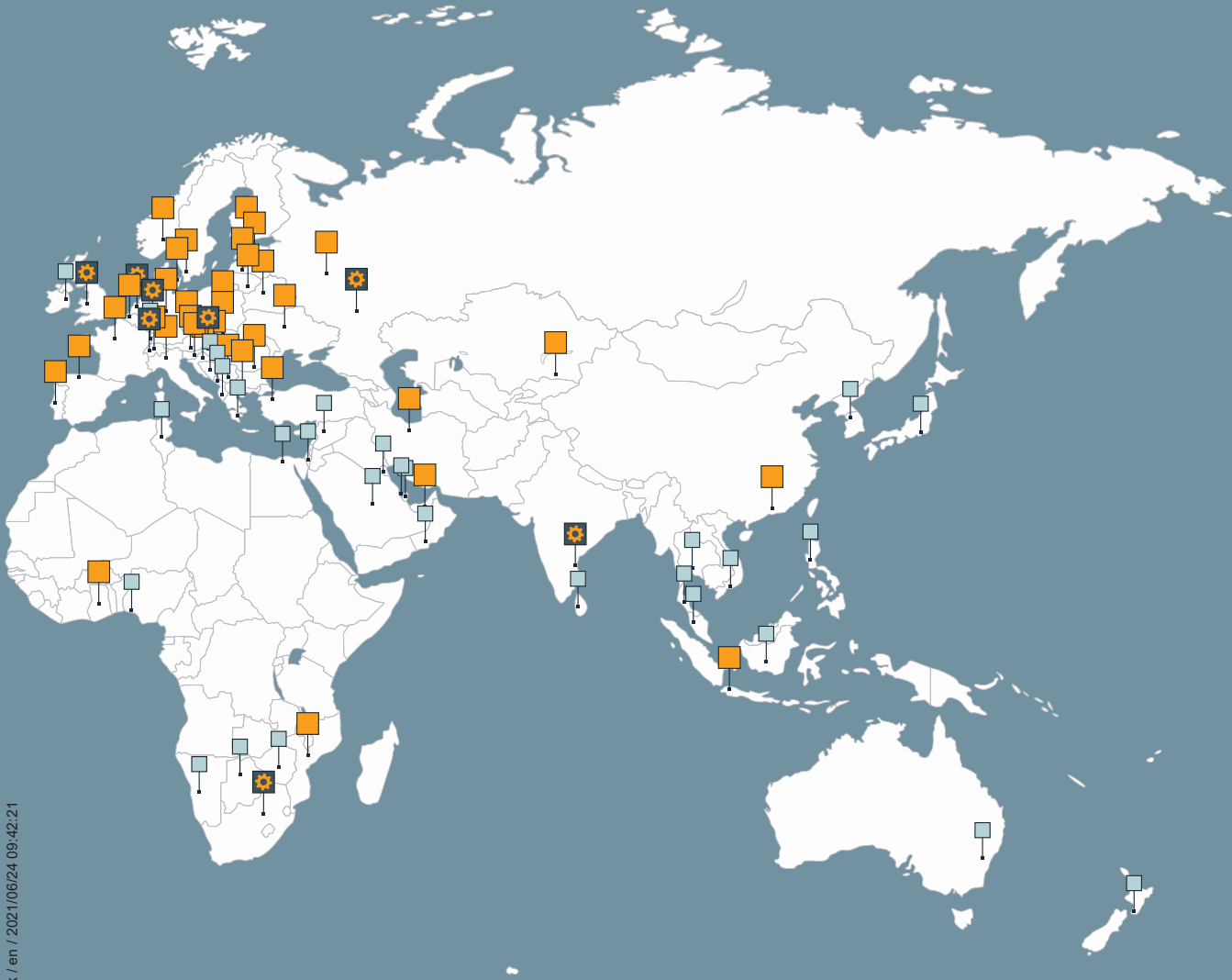

Production location



Subsidiary



Representative office

OBO Support & *contact*

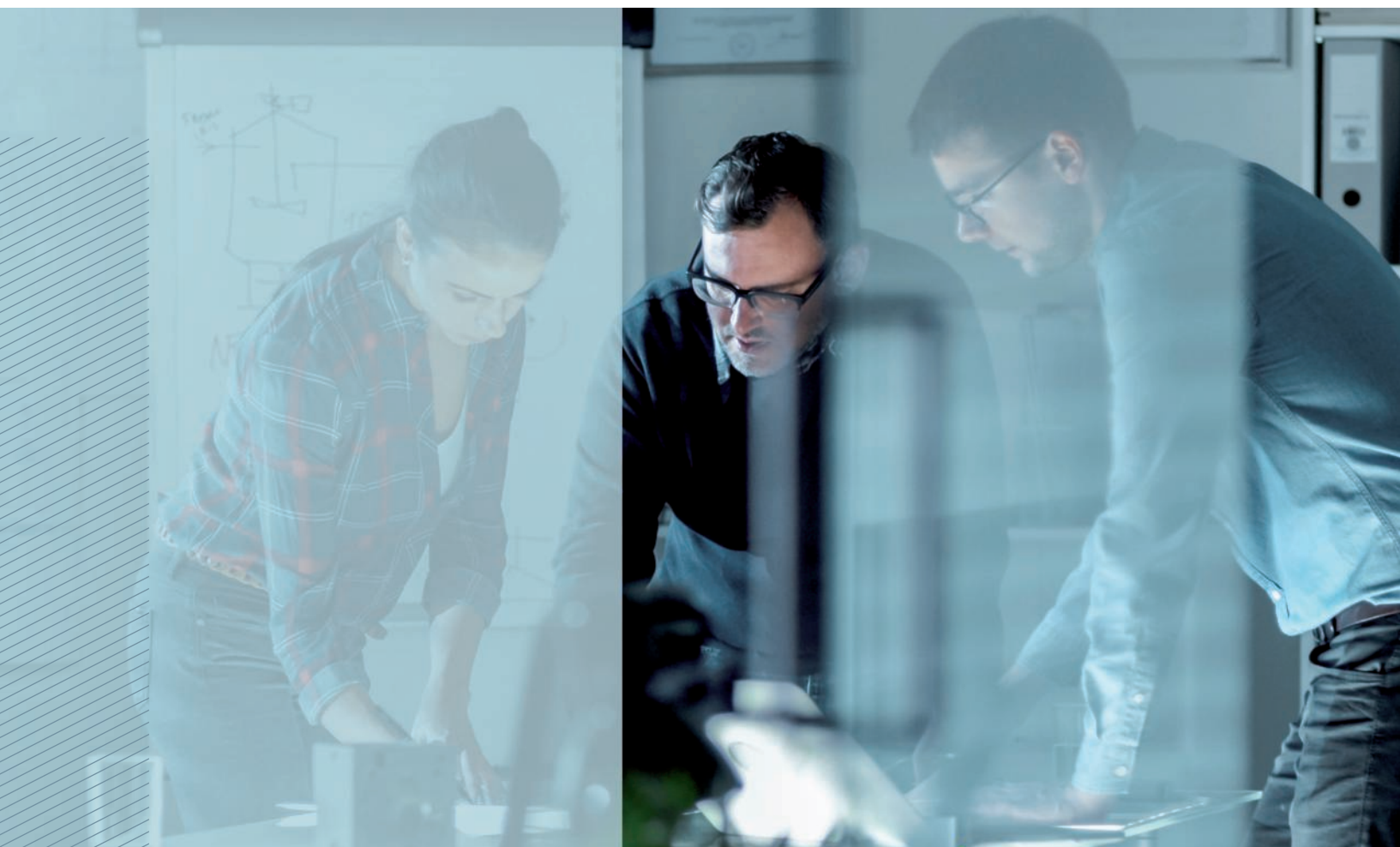

***You have a
problem?
We have the
solution!***

OBO Bettermann is more than the sum of its products. In any situation, we are the reliable partner right by your side. You have a problem? We have the solution!

It doesn't matter in which area of industry our support is needed - from industrial and plant engineering to private, public and administrative buildings, as well as in the areas of mobility and renewable energies - we have all that you need.

OBO can not only provide the entire electro-technical infrastructure with the best possible products. We can also support you with sound expert knowledge and more than 100 years of experience, right from the planning phase through to the realisation of your projects. OBO - solutions you can rely on.

You can contact our Customer Service department on:

+49 2373 89 1700

Monday–Thursday
07.30–17.00

Friday
07.30–15.00

export@obo.de



Service



Training



Handling



Certification

Service – OBO can help

Everywhere and in every project phase:

- Competent hotline
- Product and system information, digitally or printed
- Selection and planning aids on the web, as an app, as a CAD application or in printed form
- 2D and 3D product data for planning
- Field service, branch offices and subsidiaries in 60 countries
- Engineering services for major projects

Training courses from OBO

- Seminars and workshops
- Local consultation and training courses
- Planner days

Handling – OBO delivers reliably

With optimised delivery processes:

- Reliable logistics
- Practical transport systems and packaging
- Loading gear handling and disposal concepts

Certification and guarantee

OBO offers safety. Our products fulfil the most important country-specific regulations:

- Conformity (e.g. IEC, VDE, CE, KEMA, KEUR, UL)
- Certification (e.g. DIN EN, DGNB)
- 5-year guarantee for surge protection products
- Guarantee management

Connectable connection technology, Wieland GST18®, WAGO WINSTA®

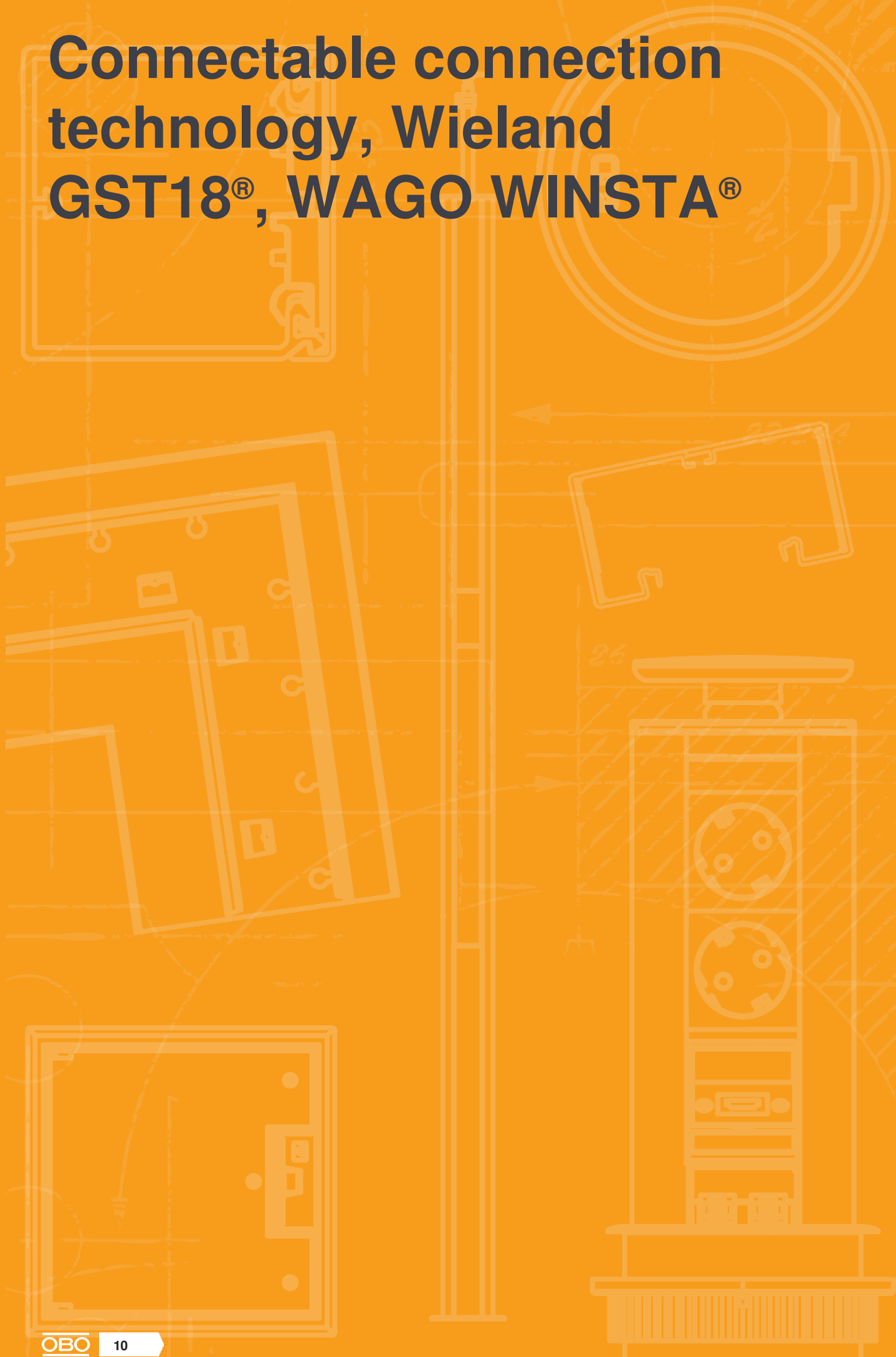

Connectable connection technology, Wieland GST18®, WAGO WINSTA®



Sockets, Modul 45connect®

22



Consolidation Point

30

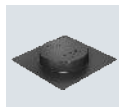

Lined body for cavity floors

32



Raised and cavity floor outlets

36



Ready-for-connection universal support



UTC3 with 2 protective contact sockets

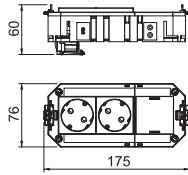

Type	Circuit	Plug-in		Pack Piece	Weight kg/100 pc.	Item no.
		system	Version for			
UTC3 G W2	1	GST18	Double pure white	1	16.370	7404662

The ready-for-connection UTC3 universal support possesses two pre-installed 33° protective contact sockets and one blanking cover for reinstallation of one installation device of the Modul 45 or Modul 45connect series. Suitable for VL connection cables and device installation units of nominal size 2, 4, R4, 6 and R7.

UTC3 with 2+1 protective contact sockets

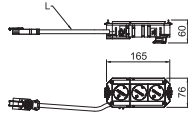

Type	Circuit	Plug-in		Pack Piece	Weight kg/100 pc.	Item no.
		system	Version for			
UTC3 G W2OR1	2	GST18	Double pure white/ single pure orange	1	26.630	7404660

Ready-for-connection UTC3 universal support with halogen-free connection cable. It possesses two pre-installed 33° protective contact sockets in white and one pre-installed 33° protective contact socket in orange of 16 A. Suitable for VL connection cables and device installation units of nominal size 2, 4, R4, 6 and R7.

UTC3 with 3 protective contact sockets

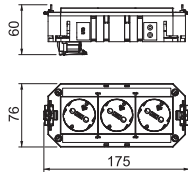

Type	Circuit	Plug-in		Pack Piece	Weight kg/100 pc.	Item no.
		system	Version for			
UTC3 G W3	1	GST18	Triple pure white	1	19.780	7404664

The ready-for-connection UTC3 universal support possesses three pre-installed 33° protective contact sockets of 16 A. Suitable for VL connection cables and device installation units of nominal size 2, 4, R4, 6 and R7.

UTC4 with 2 protective contact sockets

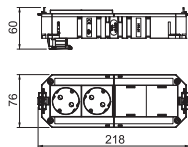

Type	Circuit	Plug-in		Pack Piece	Weight kg/100 pc.	Item no.
		system	Version for			
UTC4 G W2	1	GST18	Double pure white	1	18.500	7404674
UTC4 G OR2	1	GST18	Double pure orange	1	18.460	7404670

The ready-for-connection UTC4 universal support possesses two pre-installed 33° protective contact sockets of 16 A and two blanking covers for reinstallation of two installation devices of the Modul 45 or Modul 45connect series. Suitable for VL connection cables and device installation units of nominal size R7, R9 and 9.



UTC4 with 2+1 protective contact sockets

Type	Circuit	Plug-in system	Version for	Pack Piece	Weight kg/100 pc.	Item no.
UTC4 G OR2GN1	2	GST18	Double pure orange/ single mint green	1	32.200	7404688

Ready-for-connection universal support UTC4 with halogen-free connection cable. It possesses two pre-installed 33° protective contact sockets in orange and one 33° protective contact socket in mint green with 16 A. A blanking cover allows reinstallation of one installation device of the Modul 45 or Modul 45connect series. Suitable for VL connection cables and device installation units of nominal size R7, R9 and 9.

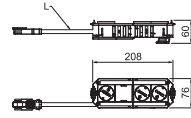

UTC4 with 2+2 protective contact sockets

Type	Circuit	Plug-in system	Version for	Pack Piece	Weight kg/100 pc.	Item no.
UTC4 G W2OR2	2	GST18	Double pure white/ double pure orange	1	27.290	7404676

The ready-for-connection UTC4 universal support possesses two pre-installed 33° protective contact sockets in pure white and two 33° pre-installed protective contact sockets in pure orange of 16 A. Suitable for VL connection cables and device installation units of nominal size R7, R9 and 9.

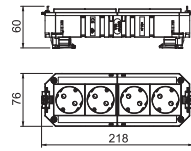

UTC4 with 2+2 protective contact sockets, 2 sockets with surge protection

Type	Circuit	Plug-in system	Version for	Pack Piece	Weight kg/100 pc.	Item no.
UTC4 G W2OR2 Ü	2	GST18	Double pure white/ double pure orange	1	31.300	7404678

The ready-for-connection UTC4 universal support possesses two pre-installed 33° protective contact sockets in pure white and two pre-installed 33° protective contact sockets in pure orange of 16 A. Suitable for VL connection cables and device installation units of nominal size R7, R9 and 9. The protective contact sockets in pure orange are protected by a type 3 surge protection module according to DIN EN 61643-11.

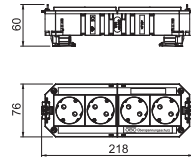

UTC4 with 3 protective contact sockets

Type	Circuit	Plug-in system	Version for	Pack Piece	Weight kg/100 pc.	Item no.
UTC4 G W3	1	GST18	Triple pure white	1	21.960	7404680

The ready-for-connection UTC4 universal support possesses three pre-installed 33° protective contact sockets of 16 A and one blanking cover for reinstallation of one installation device of the Modul 45 or Modul 45connect series. Suitable for VL connection cables and device installation units of nominal size R7, R9 and 9.

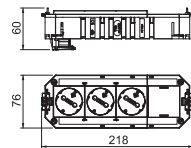

Ready-for-connection universal support



UTC4 with 3+1 protective contact sockets

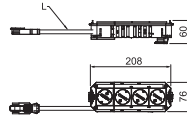

Type	Circuit	Plug-in system	Version for	Pack Piece	Weight kg/100 pc.	Item no.
UTC4 G W3OR1	2	GST18	Triple pure white/ single pure orange	1	29.510	7404684

Ready-for-connection universal support UTC4 with halogen-free connection cable. It possesses three pre-installed 33° protective contact sockets in pure white and one pre-installed 33° protective contact socket in pure orange of 16 A. Suitable for VL connection cables and device installation units of nominal size R7, R9 and 9.

UTC4 with 3+1 protective contact sockets, 1 socket with surge protection

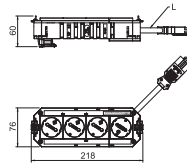
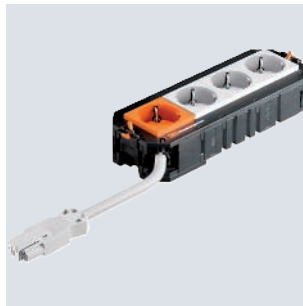

Type	Circuit	Plug-in system	Version for	Pack Piece	Weight kg/100 pc.	Item no.
UTC4 G W3OR1 Ü	2	GST18	Triple pure white/ single pure orange	1	33.530	7404686

Ready-for-connection universal support UTC4 with halogen-free connection cable. It possesses three pre-installed 33° protective contact sockets in white and one 33° protective contact socket in pure orange of 16 A. The protective contact socket in pure orange is protected by a type 3 surge protection module according to DIN EN 61643-11. Suitable for VL connection cables and device installation units of nominal size R7, R9 and 9.

UTC4 with 4 protective contact sockets

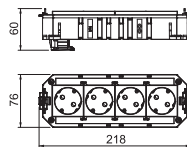

Type	Circuit	Plug-in system	Version for	Pack Piece	Weight kg/100 pc.	Item no.
UTC4 G W4	1	GST18	4x pure white	1	26.830	7404682
UTC4 G OR4	1	GST18	4x pure orange	1	26.730	7404672

The ready-for-connection UTC4 universal support possesses four pre-installed 33° protective contact sockets of 16 A. Suitable for VL connection cables and device installation units of nominal size R7, R9 and 9.

Adapter

Connection adapter, straight, socket part

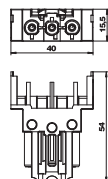

Type	Colour	Pack Piece	Weight kg/100 pc.	Item no.
BTA-SKS S1 SW	Black	10	1.200	6117190
BTA-SKS S1 W	White	10	1.200	6117191

Connector part adapter, straight, for connection to an STD-D0C / STD-D3C or STD-F0C / STD-F3C socket from the side, for VL extension cable with Wieland connector GST 18i 3p.

PA

Connection adapter, straight, connector part

Type	Colour	Pack Piece	Weight kg/100 pc.	Item no.
STA-SKS S1 SW	Black	10	1.200	6117192
STA-SKS S1 W	White	10	1.200	6117193

Connector part adapter, straight, for connection to an STD-D0C / STD-D3C or STD-F0C / STD-F3C socket from the side, for VL extension cable with Wieland connector GST 18i 3p.

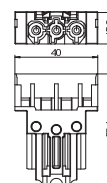

PA

Modul 45connect® connector part adapter

Type	Colour	Pack Piece	Weight kg/100 pc.	Item no.
STA-SKS SU1 SW	Black	10	1.190	6117196

Connector part adapter, U-shaped, for connection to an STD-D0C / STD-D3C or STD-F0C / STD-F3C socket from the side, for VL extension cable with Wieland connector GST 18i 3p.

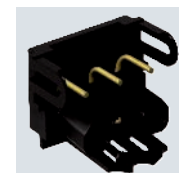
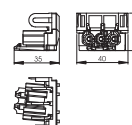

PA

Connection adapter, GST18i, straight

Type	Colour	Pack Piece	Weight kg/100 pc.	Item no.
VB-G GST18i3p	Black	10	1.760	6108045

Connection adapter GST18i for combining STD-D0C / STD-D3C or STD-F0C / STD-F3C sockets together with straight connection adapters, pluggable connection with integrated strain relief. Suitable for device connections in the device installation trunking systems Rapid 45 and Rapid 80 and in ISS service poles.

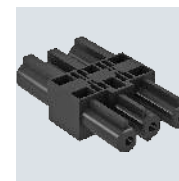
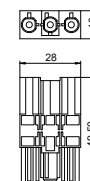

PA

Modul 45connect® connector

Type	Colour	Pack Piece	Weight kg/100 pc.	Item no.
VB-SKS S	Black	10	0.590	6117198

Connection adapter for combining STD-D0C / STD-D3C or STD-F0C / STD-F3C sockets.

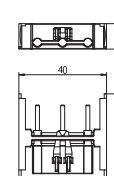

Connection cables

3-wire connection cable, halogen-free, cross-section 2.5 mm², black

Type	Cable length mm	Cross-section mm ²	Number of poles	Colour	Pack Piece	Weight kg/100 pc.	Item no.
VL-3Q2.5 H1 SW	1000	2.5	3	Black	1	16.000	6108450
VL-3Q2.5 H3 SW	3000	2.5	3	Black	1	48.000	6108452
VL-3Q2.5 H5 SW	5000	2.5	3	Black	1	80.000	6108454
VL-3Q2.5 H8 SW	8000	2.5	3	Black	1	128.000	6108457
VL-3Q2.5 H10 SW	10000	2.5	3	Black	1	160.000	6108459

Halogen-free connection cables 3 x 2.5 mm² in the version socket – connector with GST18i connection system.



Connection cables

3-wire connection cable, PVC, cross-section 2.5 mm², black



Type	Cable length mm	Cross-section mm ²	Number of poles	Colour	Pack Piece	Weight kg/100 pc.	Item no.
VL-3Q2.5 1 SW	1000	2.5	3	Black	1	18.000	6108150
VL-3Q2.5 3 SW	3000	2.5	3	Black	1	54.000	6108152
VL-3Q2.5 5 SW	5000	2.5	3	Black	1	90.000	6108154
VL-3Q2.5 8 SW	8000	2.5	3	Black	1	144.000	6108157
VL-3Q2.5 10 SW	10000	2.5	3	Black	1	180.000	6108159

Connection cable 3 x 2.5 mm² in the version socket – connector with GST18i connection system.

3-wire connection cable, halogen-free, cross-section 2.5 mm², white

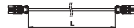

Type	Cable length mm	Cross-section mm ²	Number of poles	Colour	Pack Piece	Weight kg/100 pc.	Item no.
VL-3Q2.5 H1 W	1000	2.5	3	White	1	16.000	6108475
VL-3Q2.5 H3 W	3000	2.5	3	White	1	48.000	6108477
VL-3Q2.5 H5 W	5000	2.5	3	White	1	80.000	6108479
VL-3Q2.5 H8 W	8000	2.5	3	White	1	128.000	6108482
VL-3Q2.5 H10 W	10000	2.5	3	White	1	160.000	6108484

Halogen-free connection cables 3 x 2.5 mm² in the version socket – connector with GST18i connection system.

3-wire connection cable, PVC, cross-section 2.5 mm², white

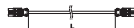

Type	Cable length mm	Cross-section mm ²	Number of poles	Colour	Pack Piece	Weight kg/100 pc.	Item no.
VL-3Q2.5 1 W	1000	2.5	3	White	1	18.000	6108175
VL-3Q2.5 3 W	3000	2.5	3	White	1	54.000	6108177
VL-3Q2.5 5 W	5000	2.5	3	White	1	90.000	6108179
VL-3Q2.5 8 W	8000	2.5	3	White	1	144.000	6108182
VL-3Q2.5 10 W	10000	2.5	3	White	1	180.000	6108184

Connection cable 3 x 2.5 mm² in the version socket – connector with GST18i connection system.

Energy distributor with GST18 connector system, fixed connection

UVS energy distributor with fixed connection, normal circuit

St

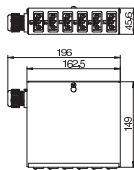

Type	Pack Piece	Weight kg/100 pc.	Item no.
UVS-6S2	1	77.000	6108000

Energy distributor for heavy current technology with fixed connection, equipped and pre-wired.

Input: One 3-phase circuit via a screwless terminal block, 5-pin, for cable cross-sections of 0.5–4 mm².
Output: Six self-locking connectors, 3-pin, in black, 16 A, type GST18i (socket part: 2 x L1, 2 x L2, 2 x L3).
Internal wiring: PVC non-sheathed cable H07V-U2.5.

Energy distributor with GST18 connector system, fixed connection

St

UVS energy distributor with fixed connection, special circuit

Type	Pack Piece	Weight kg/100 pc.	Item no.
UVS-6W2	1	77.000	6108005

Energy distributor for heavy current technology with fixed connection, equipped and pre-wired.

Input: One 3-phase circuit via a screwless terminal block, 5-pin, for cable cross-sections of 0.5–4 mm².
Output: Six self-locking connectors, 3-pin, in white, 16 A, type GST18i (socket part: 2 x L1, 2 x L2, 2 x L3).
Internal wiring: PVC non-sheathed cable H07V-U2.5.

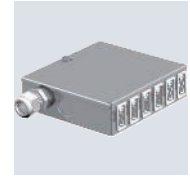
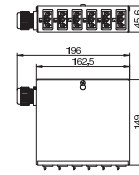

St

UVS energy distributor with fixed connection, normal and special circuit

Type	Pack Piece	Weight kg/100 pc.	Item no.
UVS-6S6W2	1	146.100	6108010

Energy distributor for heavy current technology with fixed connection, equipped and pre-wired.

Input: Two 3-phase circuits via a screwless terminal block, 5-pin, for cable cross-sections of 0.5–4 mm².
Output: Twelve self-locking connectors, 3-pin, in white (6x) and black (6x), 16 A, type GST18i (socket part: 2 x L1, 2 x L2, 2 x L3 for each rotary current circuit).
Internal wiring: PVC non-sheathed cable H07V-U2.5.

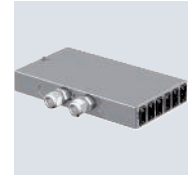
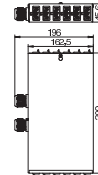

Energy distributor with GST18 connector system, plug connection

St

UVS energy distributor with plug connection, normal circuit

Type	Pack Piece	Weight kg/100 pc.	Item no.
UVS-6S2SA	1	79.000	6108012

Energy distributor for heavy current technology with plug connection, equipped and pre-wired.

Input: One 3-phase circuit using a self-locking connector, 5-pin, type GST18i (connector part).
Output: Six self-locking connectors, 3-pin, in black, 16 A, type GST18i (socket part: 2 x L1, 2 x L2, 2 x L3).
Internal wiring: PVC non-sheathed cable H07V-U2.5.

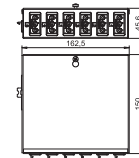

St

UVS energy distributor with plug connection, special circuit

Type	Pack Piece	Weight kg/100 pc.	Item no.
UVS-6W2SA	1	79.000	6108014

Energy distributor for heavy current technology with plug connection, equipped and pre-wired.

Input: One 3-phase circuit using a self-locking connector, 5-pin, type GST18i (connector part).
Output: Six self-locking connectors, 3-pin, in white, 16 A, type GST18i (socket part: 2 x L1, 2 x L2, 2 x L3).
Internal wiring: PVC non-sheathed cable H07V-U2.5.

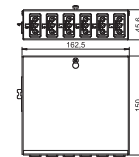

Energy distributor with GST18 connector system, plug connection

St

UVS energy distributor with plug connection, normal and special circuit

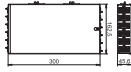

Type	Pack Piece	Weight kg/100 pc.	Item no.

Energy distributor for heavy current technology with plug connection, equipped and pre-wired.

Input: Two 3-phase circuits using self-locking connectors, 5-pin, type GST18i (connector part).

Output: Twelve self-locking connectors, 3-pin, in white (6x) and black (6x), 16 A, type GST18i (socket part: 2 x L1, 2 x L2, 2 x L3 for each rotary current circuit).

Internal wiring: PVC non-sheathed cable H07V-U2.5.

Installation accessories for Connect Wieland GST18 ®

Connector part 3-pin, spring power connection

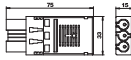
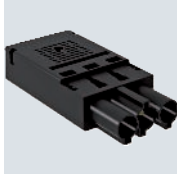

Type	Colour	Pack Piece	Weight kg/100 pc.	Item no.
ST-F GST18i3p W	White	1	2.620	6108051

Connector part, 3-pin, type GST18i with spring power connection for rigid cables of 1.5–2.5 mm², single-wire and ultrasonically welded, fine wire cables 1.5 mm² with end sleeves, unmounted with strain relief, can be terminated in situ, 250 V, 16 A.

Two connections per pole, for cables H05VV, NYM (Ø 7.8–10.33 mm), lockable, a lock should be provided for strain relief according to VDE 0628.

Stripping length: 45 mm
Stripped length: 9 mm

Connector part, 3-pin, screw connection

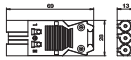

Type	Colour	Pack Piece	Weight kg/100 pc.	Item no.
ST-S GST18i3p W	White	1	2.030	6108055

Connector part, 3-pin, type GST18i with screw connection, low height (no slot loss in combination with distributor blocks), for cross-sections of 0.75–2.5 mm², single- and fine-wire cables connectable without end sleeve, for cable diameters between 6.5–10.5 mm (H05VV, NYM), unmounted with strain relief, terminable in situ, 250 V, 16 A.

Stripping length: 31 mm
Insulation removal length: 7 mm

Connector part, 3-pin, screw connection

PA

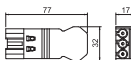

Type	Colour	Pack Piece	Weight kg/100 pc.	Item no.
ST-S4 GST18i3 W	White	1	1.600	6108062

Connector part, 3-pin, type GST18i with screw connection for cables of 1.5–4.0 mm² and cable diameters between 10.5–14.5 mm (H05VV, NYM), unmounted with strain relief, terminable in situ, 250 V, 16 A.

Connector part, 5-pin, screw connection

Type	Colour	Pack Piece	Weight kg/100 pc.	Item no.
ST-S GST18i5p SW	Black	1	4.330	6108070

Connector part, 5-pin, type GST18i, with screw connection for 1.5–2.5 mm² cables, single and fine-wire, with strain relief, one connection per pin, unmounted, for cables H05VV (Ø 9.5–13.5) NYM and (Ø 10.5–13.5 mm), lockable, according to the strain relief in VDE 0628 a lock should be planned, 250 V, 16 A.

Stripping length: 8 mm
Jacket removal length: 46 mm

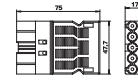

Socket section 3-pin, spring power connection

Type	Colour	Pack Piece	Weight kg/100 pc.	Item no.
BT-F GST18i3p SW	Black	1	2.620	6108052
BT-F GST18i3p W	White	1	2.690	6108053

Socket part, 3-pin, type GST18i with spring power connection for rigid cables of 1.5–2.5 mm², single-wire and ultrasonically welded, fine wire cables 1.5 mm² with end sleeves, unmounted with strain relief, can be terminated in situ, 250 V, 16 A.

Two connections per pole, for cables H05VV, NYM (Ø 7.8–10.33 mm), lockable, a lock should be provided for strain relief according to VDE 0628.

Stripping length: 45 mm
Stripped length: 9 mm

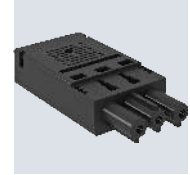
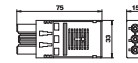

PA

Socket section 3-pin, screw connection

Type	Colour	Pack Piece	Weight kg/100 pc.	Item no.
BT-S4 GST18i3 SW	Black	1	1.600	6108064
BT-S4 GST18i3 W	White	1	1.600	6108066

Socket section, 3-pin, type GST18i with screw connection for cables of 1.5–4.0 mm² and for cable diameters between 10.5–14.5 mm (H05VV, NYM), unmounted with strain relief, terminable in situ, 250 V, 16 A.

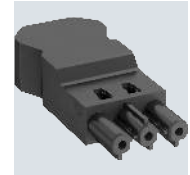
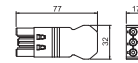

Socket section 3-pin, screw connection

Type	Colour	Pack Piece	Weight kg/100 pc.	Item no.
BT-S GST18i3p SW	Black	1	2.150	6108056
BT-S GST18i3p W	White	1	2.150	6108057

Socket part, 3-pin, type GST18i with screw connection, low height (no slot loss in combination with distributor blocks), for cross-sections of 0.75–2.5 mm², single- and fine-wire cables connectable without end sleeve, for cable diameters between 6.5–10.5 mm (H05VV, NYM), unmounted with strain relief, terminable in situ, 250 V, 16 A.

Stripping length: 31 mm
Insulation removal length: 7 mm

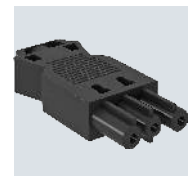
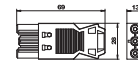

Socket section 5-pin, screw connection

Type	Colour	Pack Piece	Weight kg/100 pc.	Item no.
BT-S GST18i5p SW	Black	1	4.550	6108072

Socket part, 5-pin, type GST18i, with screw connection for 1.5 to 2.5 mm² cables, single and fine-wire, with strain relief, one connection per pin, unmounted, for cables H05VV (Ø 9.5 – 13.5) NYM and (Ø 10.5 to 13.5 mm), lockable, according to the strain relief in VDE 0628 a lock should be planned, 250 V, 16 A.

Stripping length: 8 mm
Jacket removal length: 46 mm

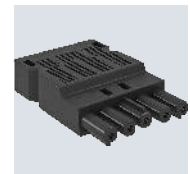
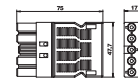

Distributor block 3-pin

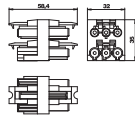
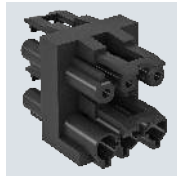

Type	Colour	Pack Piece	Weight kg/100 pc.	Item no.
VB-3 GST18i3p	Black	1	3.590	6108080

Distributor block with lock, type GST18i, one input with plug section 3-pin and three outputs with socket section 3-pin.

Distributor block 3-pin

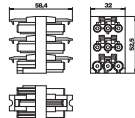
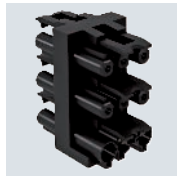

Type	Colour	Pack Piece	Weight kg/100 pc.	Item no.
VB-5 GST18i3p	Black	1	5.590	6108082

Distributor block with lock, type GST18i, one input with plug section 3-pin and five outputs with socket section 3-pin.

Distributor block, 3-pin, T-shaped

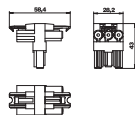

Type	Colour	Pack Piece	Weight kg/100 pc.	Item no.
VB-T GST18i3p	Black	1	2.540	6108084

T distributor with lock, type GST18i, one input with 3-pin connector part and two outputs with 3-pin socket part.

Distributor block, 3-pole

PA

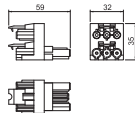

Type	Colour	Pack Piece	Weight kg/100 pc.	Item no.
VB-2 GST18i3p	Black	1	3.300	6108086

Distributor block with lock, type GST18i, 1 input with 3-pin plug section and 2 outputs with 3-pin socket section.

Surge protection module with support for Modul 45connect

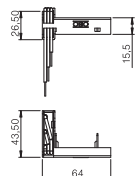

Type	Signalling on device	Pack Piece	Weight kg/100 pc.	Item no.
ÜSM-A-4T	Acoustic	1	2.226	6107801

2-pin surge protection module, 16 A/250 V~, with acoustic default display, no network switch-off, for connection to a multiple socket of type Modul 45connect using the supplied support. For installation in universal supports UT3/45 and UT4/45. The surge protection module meets EN 61643-11, type 3, Class III, requirements Class D.

PA

Locking

Type	Colour	Pack Piece	Weight kg/100 pc.	Item no.
VR-GST18	Black	10	0.100	6108074

Locking clip for GST18, plug connections, for locking connection cables.

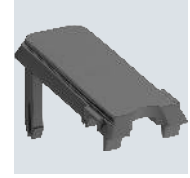
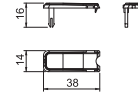

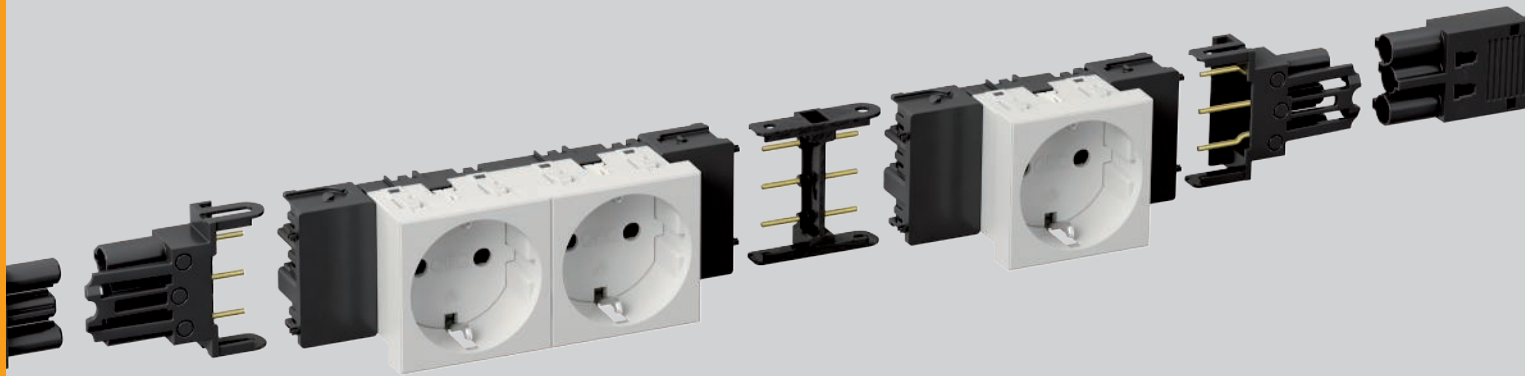

Modul 45connect®

Plug-in installation solutions for device installation trunking and service poles

As continuously connectable installation technology, the Modul 45connect® range for device installation trunking and service poles offers the highest level of flexibility, security and cost-efficiency.

From energy distribution through to device connection in the trunking, the system offers all the required installation components.



Fast installation without the need for tools, using Modul 45connect®



Safe installation through encoded connection technology



Direct mounting in the trunking – without additional components



Rapid 45

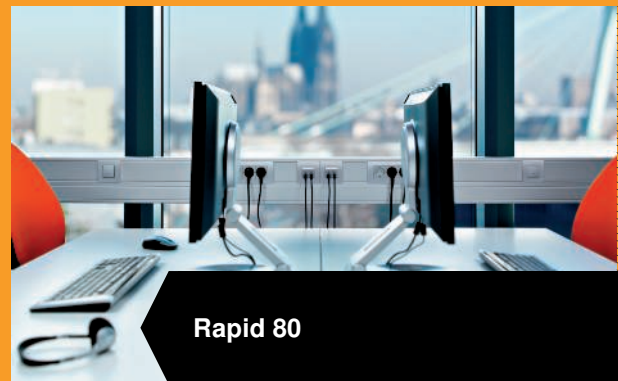

Rapid 80

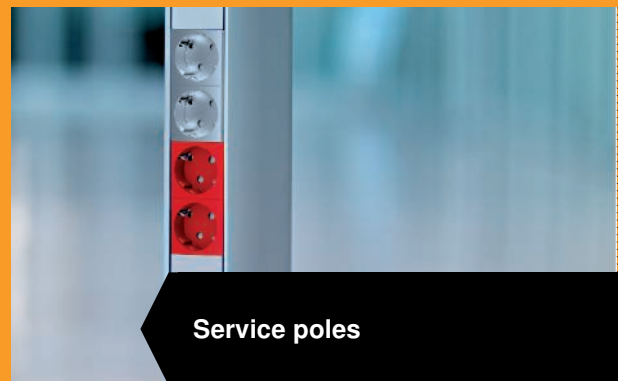

Service poles

Socket 0°, Connect 45, protective contact, single

Type	STD-D0C RW1	STD-D0C ROR1	STD-D0C MZGN1	STD-D0C SRO1	STD-D0C SWGR1	STD-D0C AL1
Colour	Pure white	Pure orange	Mint green	Signal red	Black-grey	Aluminium-painted
Pack Piece	1	1	1	1	1	1
Weight kg/100 pc.	6.700	6.700	6.700	6.700	6.700	6.700
Item no.	6120340	6120344	6120346	6120348	6120350	6120352

PC Polycarbonate

Protective contact socket with connection to side, Single 0°, with increased touch protection, with screwless terminals, 2-pin, 16 A, 250 V~, with connection terminals to IEC 60884-1, suitable for the installation in Rapid 45 device installation trunking system.

Socket 0°, Connect 45, protective contact, double

Type	STD-D0C RW2	STD-D0C ROR2	STD-D0C MZGN2	STD-D0C SRO2	STD-D0C SWGR2	STD-D0C AL2
Colour	Pure white	Pure orange	Mint green	Signal red	Black-grey	Aluminium-painted
Pack Piece	1	1	1	1	1	1
Weight kg/100 pc.	10.100	10.100	10.100	10.100	10.100	10.100
Item no.	6120362	6120364	6120366	6120368	6120370	6120372

PC Polycarbonate

Protective contact socket with connection to side, Double 0°, with increased touch protection, with screwless terminals, 2-pin, 16 A, 250 V~, with connection terminals to IEC 60884-1, suitable for the installation in Rapid 45 device installation trunking systems.

0° sockets, Modul 45connect® for device installation trunking 45-2

Socket 0°, Connect 45, protective contact, triple

Type	STD-D0C RW3	STD-D0C ROR3	STD-D0C MZGN3	STD-D0C SRO3	STD-D0C SWGR3	STD-D0C AL3
Colour	Pure white	Pure orange	Mint green	Signal red	Black-grey	Aluminium-painted
Pack Piece	1	1	1	1	1	1
Weight kg/100 pc.	16.500	16.500	16.500	16.500	16.500	16.500
Item no.	6120382	6120384	6120386	6120388	6120390	6120392

PC Polycarbonate

Protective contact socket with connection to side, Triple 0°, with increased touch protection, with screwless terminals, 2-pin, 16 A, 250 V~, with connection terminals to IEC 60884-1, suitable for the installation in Rapid 45 device installation trunking systems.

0° sockets, Modul 45connect® for device installation trunking 80

Socket 0°, Connect 80, protective contact, single

Type	STD-D0C8 RW1	STD-D0C8 ROR1	STD-D0C8 MZGN1	STD-D0C8 SRO1	STD-D0C8 SWGR1	STD-D0C8 AL1
Colour	Pure white	Pure orange	Mint green	Signal red	Black-grey	Aluminium-painted
Pack Piece	1	1	1	1	1	1
Weight kg/100 pc.	8.500	8.500	8.500	8.500	8.500	8.500
Item no.	6120412	6120414	6120416	6120418	6120420	6120422

PC Polycarbonate

Protective contact socket with connection to side, Single 0°, with increased touch protection, with screwless terminals, 2-pin, 16 A, 250 V~, with connection terminals to IEC 60884-1, suitable for the installation in Rapid 80 device installation trunking system.

Socket 0°, Connect 80, protective contact, double

	Type	STD-D0C8 RW2	STD-D0C8 ROR2	STD-D0C8 MZGN2	STD-D0C8 SRO2	STD-D0C8 SWGR2
Colour	Pure white	Pure orange	Mint green	Signal red	Black-grey	Aluminium-painted
Pack Piece	1	1	1	1	1	1
Weight kg/100 pc.	13.000	13.000	13.000	13.000	13.000	13.000
Item no.	6120432	6120434	6120436	6120438	6120440	6120442

Protective contact socket with connection to side, Double 0°, with increased touch protection, with screwless terminals, 2-pin, 16 A, 250 V~, with connection terminals to IEC 60884-1, suitable for the installation in Rapid 80 device installation trunking systems.

Socket 0°, Connect 80, protective contact, triple

	Type	STD-D0C8 RW3	STD-D0C8 ROR3	STD-D0C8 MZGN3	STD-D0C8 SRO3	STD-D0C8 SWGR3
Colour	Pure white	Pure orange	Mint green	Signal red	Black-grey	Aluminium-painted
Pack Piece	1	1	1	1	1	1
Weight kg/100 pc.	20.000	20.000	20.000	20.000	20.000	20.000
Item no.	6120452	6120454	6120456	6120458	6120460	6120462

Protective contact socket with connection to side, Triple 0°, with increased touch protection, with screwless terminals, 2-pin, 16 A, 250 V~, with connection terminals to IEC 60884-1, suitable for the installation in Rapid 80 device installation trunking systems.

Modul 45 connect 33° sockets for underfloor and service poles

Socket 33°, Connect 45, protective contact, single

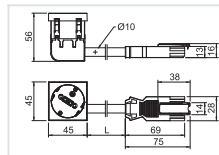

Type	STD-D3C GW ROR1	STD-D3C GW MZGN1	STD-D3C GW SRO1
Colour	Pure orange	Mint green	Signal red
Pack Piece	1	1	1
Weight kg/100 pc.	10.500	10.500	10.500
Item no.	6120832	6120834	6120836

PC Polycarbonate

Ready-for-connection protective contact socket Single 33°, with increased touch protection, incl. 0.25 m connection cable with GST18 connector and locking clip, 16 A, 250 V~.

Socket 33°, Connect 45, protective contact, double

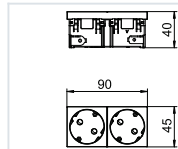

Type	STD-D3C RW2	STD-D3C ROR2	STD-D3C MZGN2	STD-D3C SRO2	STD-D3C SWGR2	STD-D3C AL2
Colour	Pure white	Pure orange	Mint green	Signal red	Black-grey	Aluminium-painted
Pack Piece	1	1	1	1	1	1
Weight kg/100 pc.	8.500	8.500	8.500	8.500	8.500	8.500
Item no.	6120482	6120484	6120486	6120488	6120490	6120492

PC Polycarbonate

Power socket with side connection Double 33°, with increased touch protection with screwless terminals, 2-pin, 16 A, 250 V~, with connection terminals to IEC 60884-1.

Socket 33°, Connect 45, protective contact, triple

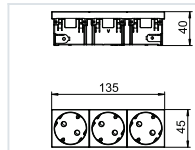

Type	STD-D3C RW3	STD-D3C ROR3	STD-D3C MZGN3	STD-D3C SRO3	STD-D3C SWGR3	STD-D3C AL3
Colour	Pure white	Pure orange	Mint green	Signal red	Black-grey	Aluminium-painted
Pack Piece	1	1	1	1	1	1
Weight kg/100 pc.	11.500	11.500	11.500	11.500	11.500	11.500
Item no.	6120502	6120504	6120506	6120508	6120510	6120512

PC Polycarbonate

Power socket with side connection Triple 33°, with increased touch protection with screwless terminals, 2-pin, 16 A, 250 V~, with connection terminals to IEC 60884-1.

PC

AR45 cover frame, single

Type	Colour	Pack Piece	Weight kg/100 pc.	Item no.
AR45-F1 RW	Pure white	1	1.600	6119322
AR45-F1 SWGR	Black-grey	1	1.600	6119324
AR45-F1 AL	Aluminium-painted	1	1.600	6119326

Front locking cover frame for Modul 45 devices, single, without labelling panel for horizontal and vertical device installation, for locking in accessory mounting box 71GD8-2.

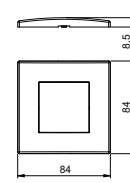

PC

AR45 cover frame, single, with labelling panel for horizontal device installation

Type	Colour	Pack Piece	Weight kg/100 pc.	Item no.
AR45-BF1 RW	Pure white	1	1.500	6119332
AR45-BF1 SWGR	Black-grey	1	1.500	6119334
AR45-BF1 AL	Aluminium-painted	1	1.500	6119336

Front locking cover frame for Modul 45 devices, single, with labelling panel for horizontal device installation, for locking in accessory mounting box 71GD8-2.

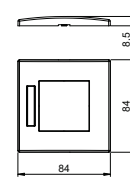

PC

AR45 cover frame, single, with labelling panel for vertical device installation

Type	Colour	Pack Piece	Weight kg/100 pc.	Item no.
AR45-BSF1 RW	Pure white	1	1.500	6119338
AR45-BSF1 SWGR	Black-grey	1	1.500	6119339
AR45-BSF1 AL	Aluminium-painted	1	1.500	6119340

Front locking cover frame for Modul 45 devices, single, with labelling panel for vertical device installation, for locking in accessory mounting box 71GD8-2.

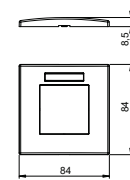

PC

AR45 cover frame, double

Type	Colour	Pack Piece	Weight kg/100 pc.	Item no.
AR45-F2 RW	Pure white	1	2.320	6119342
AR45-F2 SWGR	Black-grey	1	2.320	6119344
AR45-F2 AL	Aluminium-painted	1	2.320	6119346

Front locking cover frame for Modul 45 devices, single, without labelling panel for horizontal and vertical device installation, for locking in accessory mounting box 71GD13 or in mounting support 71MT2 45.

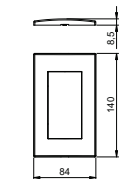

PC

AR45 cover frame, double, with labelling panel for horizontal device installation

Type	Colour	Pack Piece	Weight kg/100 pc.	Item no.
AR45-BF2 RW	Pure white	1	2.260	6119352
AR45-BF2 SWGR	Black-grey	1	2.260	6119354
AR45-BF2 AL	Aluminium-painted	1	2.260	6119356

Front locking cover frame for Modul 45 devices, double, with labelling panel for horizontal device installation, for locking in accessory mounting box 71GD13 or in mounting support 71MT2 45.

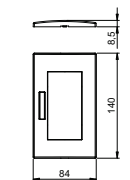

AR45 cover frame, double, with labelling panel for vertical device installation

PC

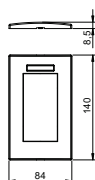

Type	Colour		Pack Piece	Weight kg/100 pc.	Item no.
AR45-BSF2 RW	Pure white		1	2.260	6119362
AR45-BSF2 SWGR	Black-grey		1	2.260	6119364
AR45-BSF2 AL	Aluminium-painted		1	2.260	6119366

Front locking cover frame for Modul 45 devices, double, with labelling panel for vertical device installation, for locking in accessory mounting box 71GD13 or in mounting support 71MT2 45.

AR45 cover frame, triple

PC

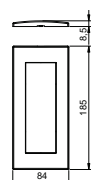

Type	Colour		Pack Piece	Weight kg/100 pc.	Item no.
AR45-F3 RW	Pure white		1	2.800	6119372
AR45-F3 SWGR	Black-grey		1	2.800	6119374
AR45-F3 AL	Aluminium-painted		1	2.800	6119376

Front locking cover frame for Modul 45 devices, triple, without labelling panel for horizontal and vertical device installation, for locking in accessory mounting box 71GD9-2 or in mounting support 71MT3 45-2.

AR45 cover frame, triple, with labelling panel for horizontal device installation

PC

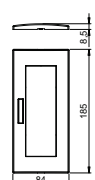
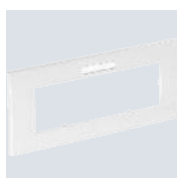

Type	Colour		Pack Piece	Weight kg/100 pc.	Item no.
AR45-BF3 RW	Pure white		1	2.800	6119382
AR45-BF3 SWGR	Black-grey		1	2.800	6119384
AR45-BF3 AL	Aluminium-painted		1	2.800	6119386

Front locking cover frame for Modul 45 devices, triple, with labelling panel for horizontal device installation, for locking in accessory mounting box 71GD9-2 or in mounting support 71MT3 45-2.

AR45 cover frame, triple, with labelling panel for vertical device installation

PC

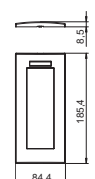

Type	Colour		Pack Piece	Weight kg/100 pc.	Item no.
AR45-BSF3 RW	Pure white		1	2.800	6119387
AR45-BSF3 SWGR	Black-grey		1	2.800	6119388
AR45-BSF3 AL	Aluminium-painted		1	2.800	6119389

Front locking cover frame for Modul 45 devices, triple, with labelling panel for vertical device installation, for locking in accessory mounting box 71GD9-2 or in mounting support 71MT3 45-2.

AR50 cover frame, single

PC

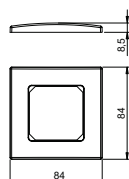
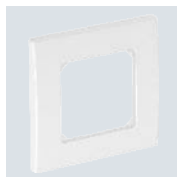

Type	Colour		Pack Piece	Weight kg/100 pc.	Item no.
AR50-F1 RW	Pure white		1	1.620	6119392
AR50-F1 SWGR	Black-grey		1	1.620	6119394
AR50-F1 AL	Aluminium-painted		1	1.620	6119396

Front locking cover frame for devices with 50 mm central plate, single, without labelling panel for horizontal and vertical device installation, for mounting on accessory mounting box 71GD6, 71GD11 or in mounting support 71MTD.

PA

Mounting support, single, for Modul 45®

Type	Colour	Pack Piece	Weight kg/100 pc.	Item no.
71MT1 45	Light grey	10	2.000	6288572

Front locking single mounting support for Modul 45 data technology systems and Modul 45connect protective contact sockets with Wieland connection.

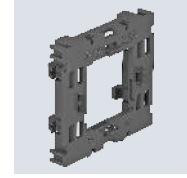
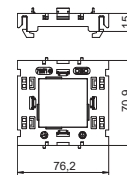

PA

Mounting support, double, for Modul 45®

Type	Colour	Pack Piece	Weight kg/100 pc.	Item no.
71MT2 45	Light grey	5	3.050	6288576

Front locking double mounting support for Modul 45 data technology systems and Modul 45connect protective contact sockets with Wieland connection.

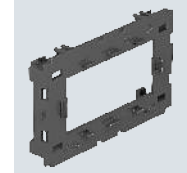
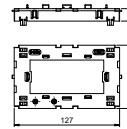

PA

Mounting support, triple, for Modul 45®

Type	Colour	Pack Piece	Weight kg/100 pc.	Item no.
71MT3 45-2	Light grey	5	3.200	6288574

Front locking double/triple mounting support for Modul 45 data technology systems and Modul 45connect protective contact sockets with Wieland connection.

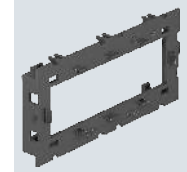
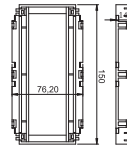

PA

Mounting support for data technology

Type	Colour	Pack Piece	Weight kg/100 pc.	Item no.
71MTD	Light grey	5	1.640	6288577

Mounting support for the installation of data technology devices in device installation trunking of the Rapid 80 series and ISS service poles with 80 mm system opening.

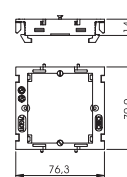

Consolidation Point

CP empty housing

St

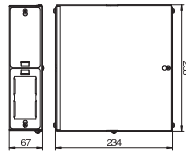

Type	Pack Piece	Weight kg/100 pc.	Item no.
CP45-LG 8A	1	190.000	6108037

Consolidation Point empty housing for the installation of 4 Modul 45® devices, consisting of housing base and cover, a cover hood to separate data technology and heavy current, 2 support plates for the installation of 2 Modul 45® accessories each, 2 blanking plates, 2 cable glands V-TEC VM25 LGR and a protective conductor connection bracket.

CP support plate, for Modul 45® devices, double

St

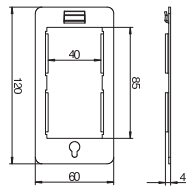
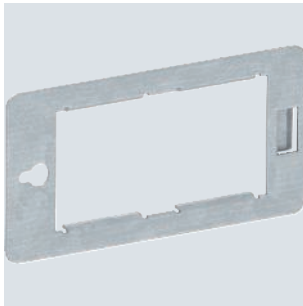

Type	Pack Piece	Weight kg/100 pc.	Item no.
CP45-TP M	1	4.200	6108039

Support plate to accommodate 2 Modul 45® devices in a Consolidation Point housing.

CP support plate for 3 snap-in plug connectors, 3-pole

St

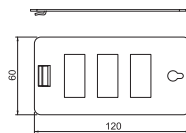
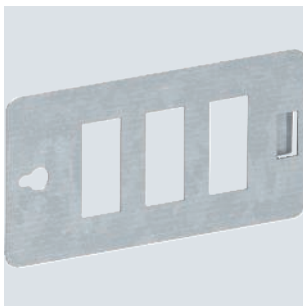

Type	Pack Piece	Weight kg/100 pc.	Item no.
CP45-TP 3SI	1	6.200	6108024

Support plate to accept three snap-in connectors, 3-pole, in a Consolidation Point housing.

St

CP support plate for 4 snap-in plug connectors, 3-pole

Type	Pack Piece	Weight kg/100 pc.	Item no.
CP45-TP 4SI	1	5.700	6108026

Support plate to accept four snap-In connectors, 3-pole, in a Consolidation Point housing.

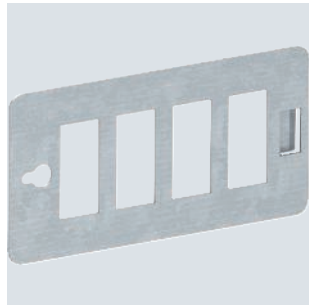
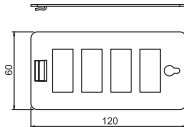

St

CP support plate, for 8 data connection modules, type C

Type	Pack Piece	Weight kg/100 pc.	Item no.
CP45-TP 8C	1	5.400	6108028

Support plate, type C, to accept eight data connection modules in a Consolidation Point housing. Type C has a mounting opening of 19.30 x 14.80 mm.

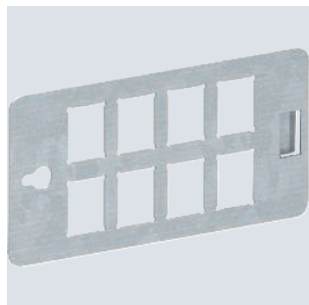
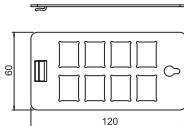

Type	Pack Piece	Weight kg/100 pc.	Item no.
CP45-KL	1	2.000	6108043

Screwless terminal strip with locking foot, 5-pin for a cable cross-section of 0.5–4 mm².

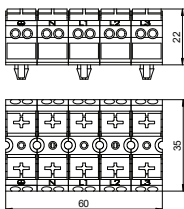

Terminal strip



Lined body solution for polished screeds

Using the special lined body system for terrazzo floors and polished screeds, height-adjustable cassettes can be installed perfectly in surface-finished screeds. The lined body system can be polished with the screed layer.

- Joint-free installation in terrazzo and polished screeds
- Application for height-adjustable cassettes



- Mounting protection lid protects the cassettes during the screed work
- Cassettes with 20 and 25 mm floor covering recess
- Cassettes with tube body or cord outlet

PS

Lined body for rectangular installation unit of nominal size 4

Type	Screed height mm	Pack Piece	Weight kg/100 pc.	Item no.
SK HB 201X201	50	1	15.000	7425600

Screed protection cover for cavity floor with screed topping for height-adjustable square cassettes of nominal size 4.

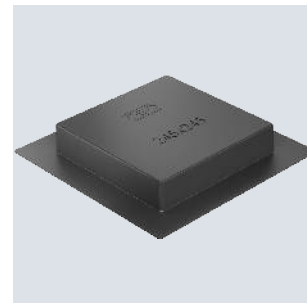
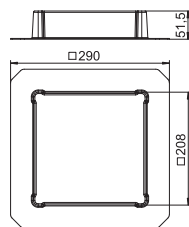

PS

Lined body for rectangular installation unit of nominal size 9

Type	Screed height mm	Pack Piece	Weight kg/100 pc.	Item no.
SK HB 245X245	50	1	19.500	7404412

Screed protection cover for cavity floor with screed topping for height-adjustable square cassettes of nominal size 9.

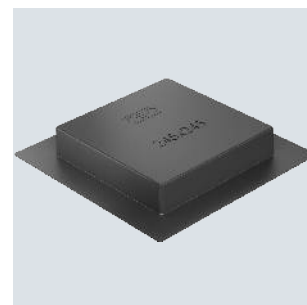
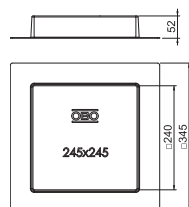

Lined body for round installation units

PS

Lined body for round installation unit of nominal size R4

Type	Dimension d mm	Screed height mm	Pack Piece	Weight kg/100 pc.	Item no.
SK HB R215	215	50	1	15.000	7404400

Screed protection cover for cavity floor with screed topping for round service outlets and height-adjustable cassettes of nominal size R4.

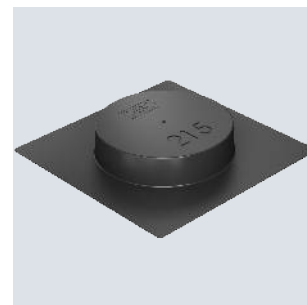
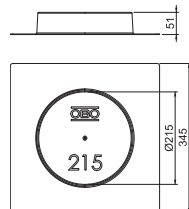

PS

Lined body for round installation unit of nominal size R7

Type	Dimension d mm	Screed height mm	Pack Piece	Weight kg/100 pc.	Item no.
SK HB R275	275	50	1	22.000	7404404

Screed protection cover for cavity floor with screed topping for round service outlets and height-adjustable cassettes of nominal size R7.

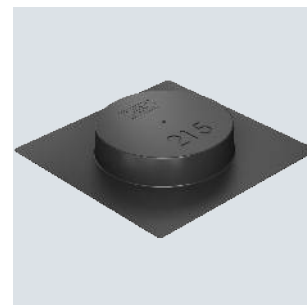
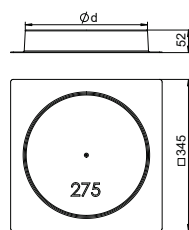

Lined body for round installation units

PS

Lined body for round installation unit of nominal size R9

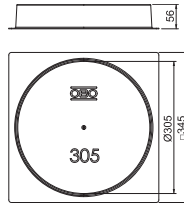
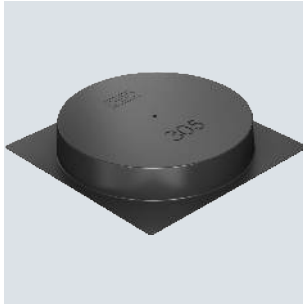

Type	Dimension d Ø mm	Screed height mm	Pack Piece	Weight kg/100 pc.	Item no.
SK HB R305	305	50	1	22.000	7404408

Screed protection cover for cavity floor with screed topping for round service outlets and height-adjustable cassettes of nominal size R9.

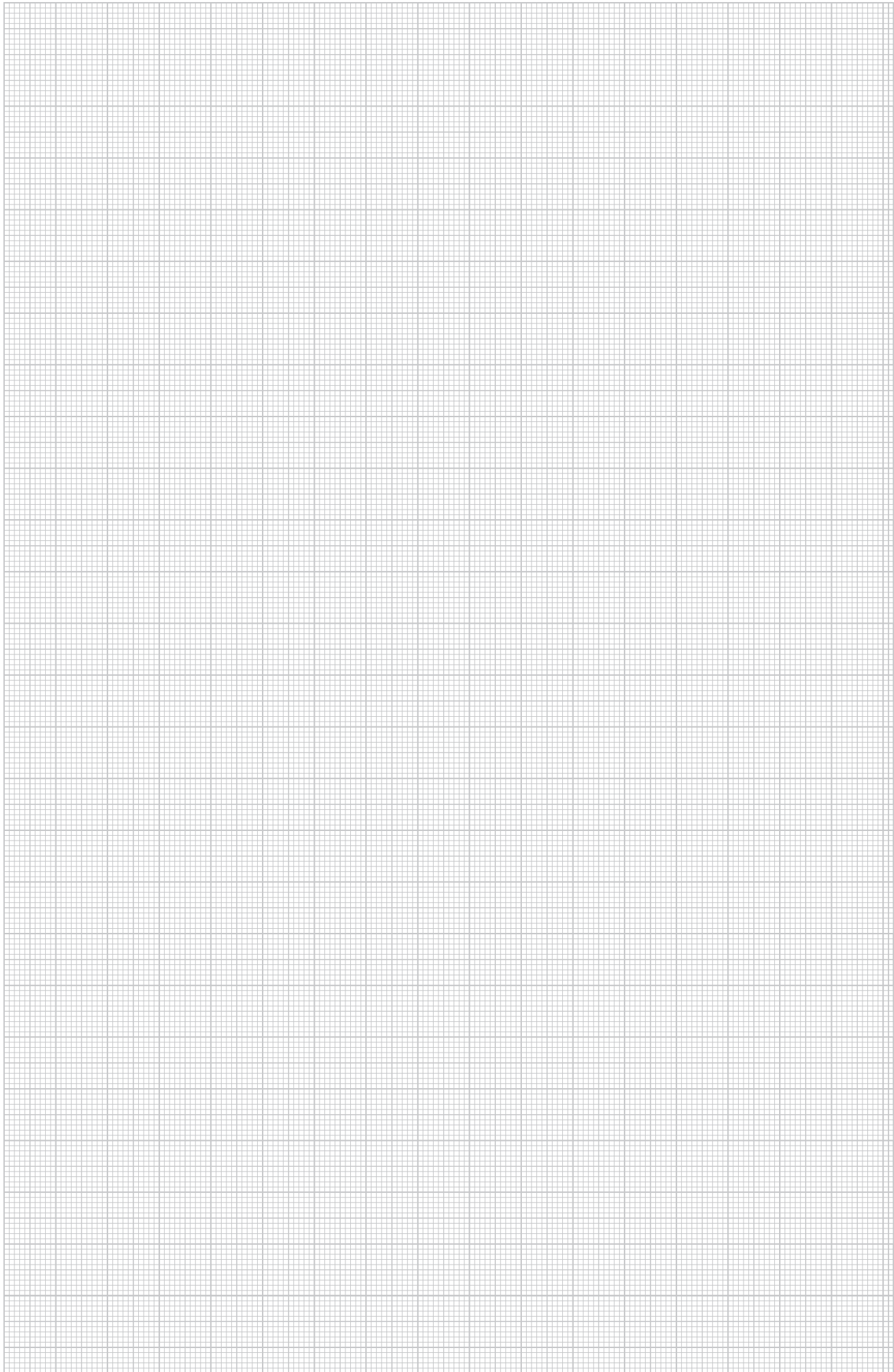

Cable outlet with tube body

PA

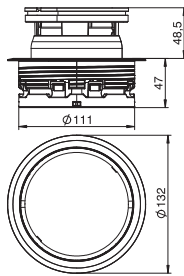
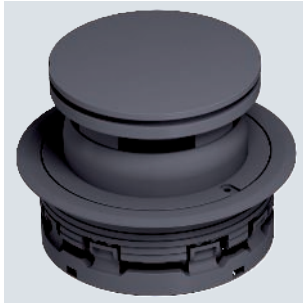
Cord outlet for raised floor for dry-care floor,
with tube body

Type	Colour	Pack Piece	Weight kg/100 pc.	Item no.
ULA DB T 7011	Iron grey	1	20.100	7407896

Cord outlet for installation in wet-cleaned raised floors for indoor use. The cord outlet can be closed flush to the floor if unused.

Cable outlet with cord outlet

PA

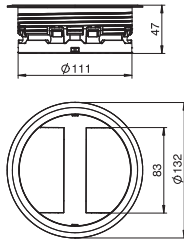
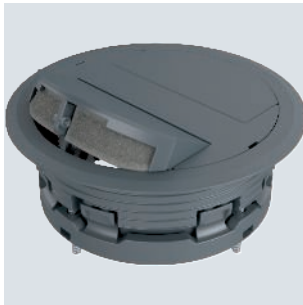
Cord outlet for raised floor for dry-care floor,
with cord outlet

Type	Colour	Pack Piece	Weight kg/100 pc.	Item no.
ULA DB SA 7011	Iron grey	1	21.200	7407894

Cord outlet for installation in dry and moist-cleaned raised floors for indoor use. The cord outlet can be closed flush to the floor if unused.

Cable outlet, blank

PA

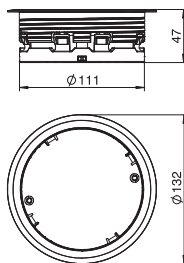
Cord outlet for raised floor for dry-care floor,
blank

Type	Depth of the floor covering recess mm	Colour	Pack Piece	Weight kg/100 pc.	Item no.
ULA DB 7011	5	Iron grey	1	130.000	7407898

Blanking lock of an opening in a raised floor for indoor use, intended for the installation of a cord outlet.

Zn

Raised ring – AR80 24

Type	Dimension d Ø mm	Pack Piece	Weight kg/100 pc.	Item no.
AR80 24	86	1	13.430	7406928

Stacking ring for height stacking of the mounting level in a UDL2/80 underfloor outlet box or the US80 single duct outlet.

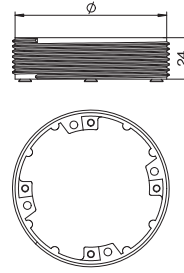

St FS

Blanking disc

Type	Pack Piece	Weight kg/100 pc.	Item no.
DBS 80	1	9.500	7400768



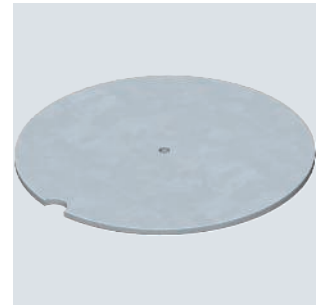
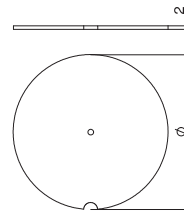

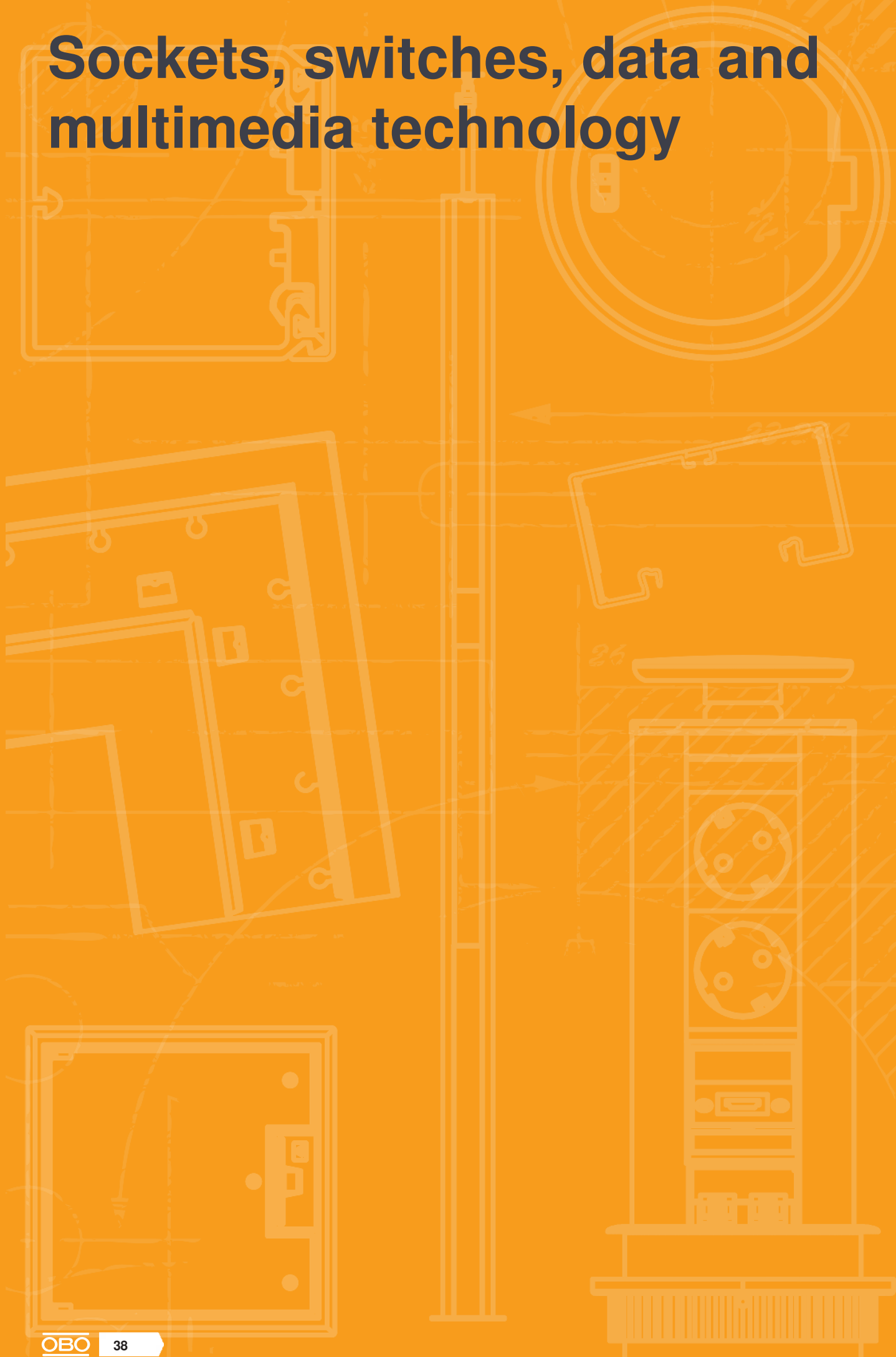

Protective mounting lid for a US80 underfloor outlet.



Sockets, switches, data and multimedia technology



Sockets, switches, data and multimedia technology

	Sockets	40
	Accessories, sockets	54
	Switch	58
	Data technology support	62
	Accessories, data technology support	72
	Data technology modules	78
	Multimedia technology	82



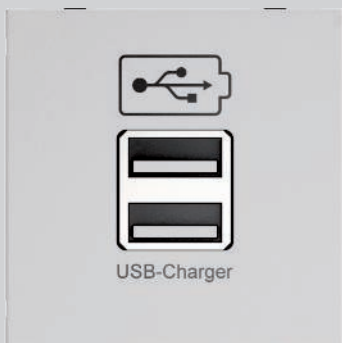
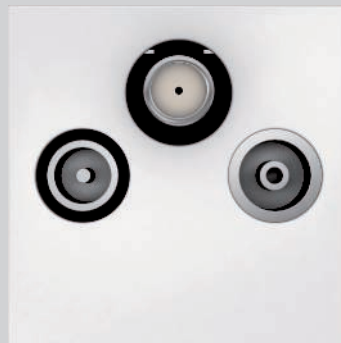

Modul 45[®] Devices

With their dimensions of 45 x 45 mm, the Modul 45[®] devices from OBO Bettermann are compact and space-saving. For this reason, the sockets, data and multimedia technology connections are ideal for use in underfloor systems, device installation trunking and service poles. The Modul 45[®] system makes optimum use of limited installation space.

The advantages of Modul 45[®] at a glance:

- Space savings thanks to compact design
- Modular structure
- Quick and easy planning
- Simple mounting
- High efficiency due to time and cost savings
- Wide range of application options
- Easy exchangeability



Installation in floor boxes



Installation in
device installation trunking



Installation in
service poles

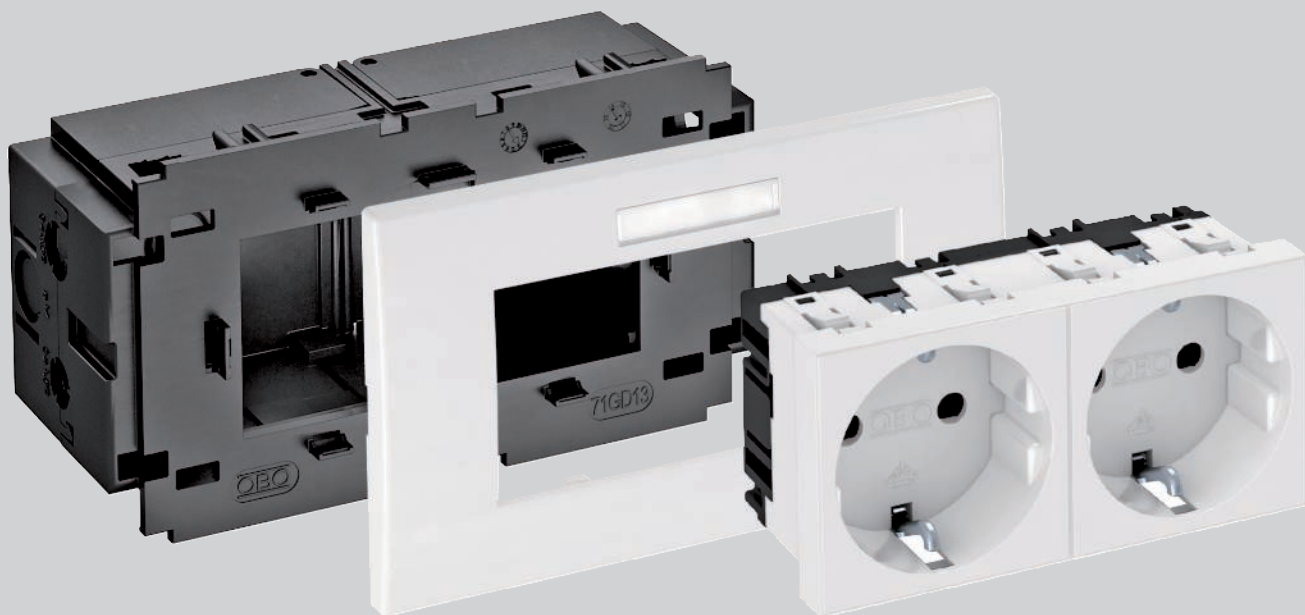

Modul 45[®] and standard

Installation solutions for device installation trunking and service poles with 80 mm system opening

The Modul 45[®] devices from OBO Bettermann are compact and space-saving. They are therefore ideal for use in device installation trunking and service poles. The Modul 45[®] system makes optimum use of limited installation space.

The advantages of Modul 45[®] at a glance:

- Space savings thanks to compact design
- Modular structure
- Quick and easy planning
- Simple mounting
- High efficiency due to time and cost savings
- Wide range of application options
- Easy exchangeability



Rapid 45



Rapid 80

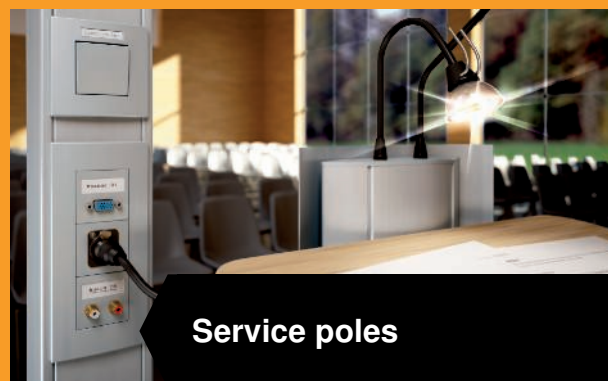

Service poles

With protective contact

0° socket, protective contact, single



Type	STD-D0 RW1	STD-D0 ROR1	STD-D0 MZGN1	STD-D0 SRO1	STD-D0 SWGR1	STD-D0 AL1
Colour	Pure white	Pure orange	Mint green	Signal red	Black-grey	Aluminium-painted
Pack Piece	1	1	1	1	1	1
Weight kg/100 pc.	4.200	4.200	4.200	4.200	4.200	4.200
Item no.	6120008	6120010	6120012	6120014	6120016	6120018

PC Polycarbonate

Power socket Single 0°, with increased touch protection with screwless terminals, 2-pin, 16 A, 250 V~, with connection terminals to IEC 60884-1.

0° socket, protective contact, double

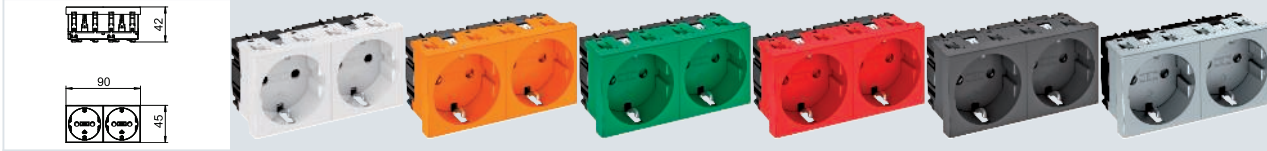

Type	STD-D0 RW2	STD-D0 ROR2	STD-D0 MZGN2	STD-D0 SRO2	STD-D0 SWGR2	STD-D0 AL2
Colour	Pure white	Pure orange	Mint green	Signal red	Black-grey	Aluminium-painted
Pack Piece	1	1	1	1	1	1
Weight kg/100 pc.	8.000	8.000	8.000	8.000	8.000	8.000
Item no.	6120022	6120024	6120026	6120028	6120030	6120032

PC Polycarbonate

Power socket Double 0°, with increased touch protection with screwless terminals, 2-pin, 16 A, 250 V~, with connection terminals to IEC 60884-1.

0° socket, protective contact, triple





Type	STD-D0 RW3	STD-D0 ROR3	STD-D0 MZGN3	STD-D0 SRO3	STD-D0 SWGR3	STD-D0 AL3
Colour	Pure white	Pure orange	Mint green	Signal red	Black-grey	Aluminium-painted
Pack Piece	1	1	1	1	1	1
Weight kg/100 pc.	12.200	12.200	12.200	12.200	12.200	12.200
Item no.	6120042	6120044	6120046	6120048	6120050	6120052

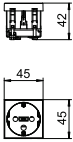

PC Polycarbonate

Power socket Triple 0°, with increased touch protection with screwless terminals, 2-pin, 16 A, 250 V~, with connection terminals to IEC 60884-1.

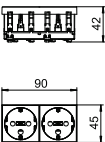

0° socket, protective contact, encoded version, single

	
Type	STD-D0K SRO1
Colour	Signal red
Pack Piece	1
Weight kg/100 pc.	4.200
Item no.	6120292
	PC Polycarbonate
<p>Protective contact socket Single 0°, encoded version, with increased touch protection, with screwless terminals, 2-pin, 16 A, 250 V~, with connection terminals according to IEC 60884-1. The socket can only be used in connection with an encoding pin of type CST-STD.</p> <p>Note: The encoding pin is not contained in the scope of supply.</p>	

0° socket, protective contact, encoded version, double

	
Type	STD-D0K SRO2
Colour	Signal red
Pack Piece	1
Weight kg/100 pc.	8.000
Item no.	6120294
	PC Polycarbonate
<p>Protective contact socket Double 0°, encoded version, with increased touch protection, with screwless terminals, 2-pin, 16 A, 250 V~, with connection terminals according to IEC 60884-1. The socket can only be used in connection with an encoding pin of type CST-STD.</p> <p>Note: The encoding pin is not contained in the scope of supply.</p>	

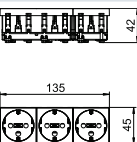
0° socket, protective contact, encoded version, triple

	
Type	STD-D0K SRO3
Colour	Signal red
Pack Piece	1
Weight kg/100 pc.	12.200
Item no.	6120296
	PC Polycarbonate
<p>Protective contact socket Triple 0°, encoded version, with increased touch protection, with screwless terminals, 2-pin, 16 A, 250 V~, with connection terminals according to IEC 60884-1. The socket can only be used in connection with an encoding pin of type CST-STD.</p> <p>Note: The encoding pin is not contained in the scope of supply.</p>	

33° socket, protective contact, single



Type	STD-D3 RW1	STD-D3 ROR1	STD-D3 MZGN1	STD-D3 SRO1	STD-D3 SWGR1	STD-D3 AL1
Colour	Pure white	Pure orange	Mint green	Signal red	Black-grey	Aluminium-painted
Pack Piece	1	1	1	1	1	1
Weight kg/100 pc.	4.000	4.000	4.000	4.000	4.000	4.000
Item no.	6120072	6120074	6120076	6120078	6120080	6120082

PC Polycarbonate

Power socket Single 33°, with increased touch protection with screwless terminals, 2-pin, 16 A, 250 V~, with connection terminals to IEC 60884-1.

33° socket, protective contact, double

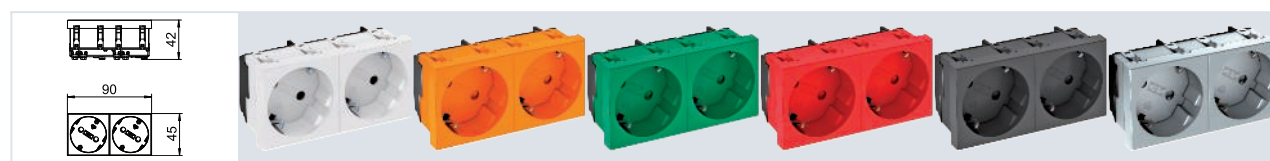

Type	STD-D3 RW2	STD-D3 ROR2	STD-D3 MZGN2	STD-D3 SRO2	STD-D3 SWGR2	STD-D3 AL2
Colour	Pure white	Pure orange	Mint green	Signal red	Black-grey	Aluminium-painted
Pack Piece	1	1	1	1	1	1
Weight kg/100 pc.	7.800	7.800	7.800	7.800	7.800	7.800
Item no.	6120102	6120104	6120106	6120108	6120110	6120112

PC Polycarbonate

Power socket Double 33°, with increased touch protection with screwless terminals, 2-pin, 16 A, 250 V~, with connection terminals to IEC 60884-1.

33° socket, protective contact, triple

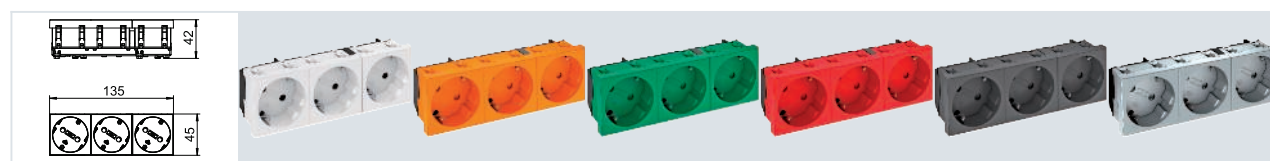

Type	STD-D3 RW3	STD-D3 ROR3	STD-D3 MZGN3	STD-D3 SRO3	STD-D3 SWGR3	STD-D3 AL3
Colour	Pure white	Pure orange	Mint green	Signal red	Black-grey	Aluminium-painted
Pack Piece	1	1	1	1	1	1
Weight kg/100 pc.	11.000	11.000	11.000	11.000	11.000	11.000
Item no.	6120122	6120124	6120126	6120128	6120130	6120132

PC Polycarbonate

Power socket Triple 33°, with increased touch protection with screwless terminals, 2-pin, 16 A, 250 V~, with connection terminals to IEC 60884-1.

Socket 33°, protective contact, encoded version



Type	STD-D3K SRO1
Colour	Signal red
Pack Piece	1
Weight kg/100 pc.	4.000
Item no.	6120302

PC Polycarbonate

Protective contact socket Single 33°, encoded version, with increased touch protection, with screwless terminals, 2-pin, 16 A, 250 V~, with connection terminals according to IEC 60884-1.
The socket can only be used in connection with an encoding pin of type CST-STD.

Note: The encoding pin is not contained in the scope of supply.

33° socket, protective contact, encoded version, double

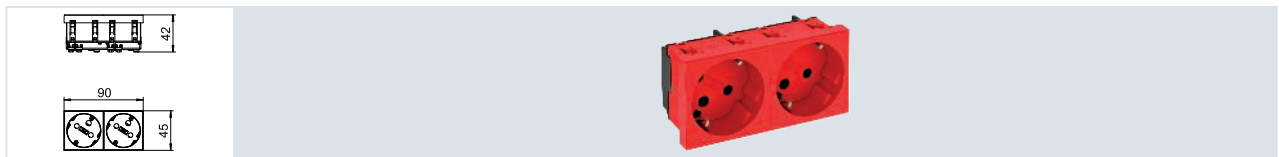

Type	STD-D3K SRO2
Colour	Signal red
Pack Piece	1
Weight kg/100 pc.	7.700
Item no.	6120304

PC Polycarbonate

Protective contact socket Double 33°, encoded version, with increased touch protection, with screwless terminals, 2-pin, 16 A, 250 V~, with connection terminals according to IEC 60884-1.
The socket can only be used in connection with an encoding pin of type CST-STD.

Note: The encoding pin is not contained in the scope of supply.

33° socket, protective contact, encoded version, triple

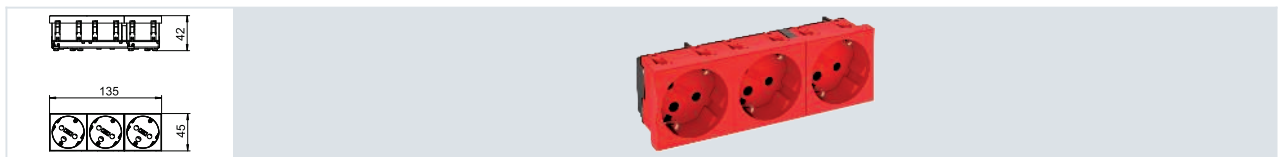

Type	STD-D3K SRO3
Colour	Signal red
Pack Piece	1
Weight kg/100 pc.	11.000
Item no.	6120306

PC Polycarbonate

Protective contact socket Triple 33°, encoded version, with increased touch protection, with screwless terminals, 2-pin, 16 A, 250 V~, with connection terminals according to IEC 60884-1.
The socket can only be used in connection with an encoding pin of type CST-STD.

Note: The encoding pin is not contained in the scope of supply.

With earthing pin

Socket 0°, with earthing pin

 	
Type	STD-F0 RW1
Colour	Pure white
Pack Piece	1
Weight kg/100 pc.	4.000
Item no.	6120152
	PC Polycarbonate
Socket with earthing pin, single 0°, with increased touch protection, with screwless terminals, 2-pin, 16 A, 250 V~, with connection terminals to IEC 60884-1.	

0° socket, with earthing pin, double

 	
Type	STD-F0 RW2
Colour	Pure white
Pack Piece	1
Weight kg/100 pc.	7.700
Item no.	6120172
	PC Polycarbonate
Socket with earthing pin, double 0°, with increased touch protection, with screwless terminals, 2-pin, 16 A, 250 V~, with connection terminals to IEC 60884-1.	

0° socket, with earthing pin, triple

 	
Type	STD-F0 RW3
Colour	Pure white
Pack Piece	1
Weight kg/100 pc.	11.800
Item no.	6120192
	PC Polycarbonate
Socket with earthing pin, triple 0°, with increased touch protection, with screwless terminals, 2-pin, 16 A, 250 V~, with connection terminals to IEC 60884-1.	

Socket 33°, with earthing pin

	
Type	STD-F3 RW1
Colour	Pure white
Pack Piece	1
Weight kg/100 pc.	3.800
Item no.	6120222
	PC Polycarbonate
Socket with earthing pin Single 33°, with increased touch protection, with screwless terminals, 2-pin, 16 A, 250V ~, with connection terminals to IEC 60884-1.	

33° socket, with earthing pin, double

	
Type	STD-F3 RW2
Colour	Pure white
Pack Piece	1
Weight kg/100 pc.	7.500
Item no.	6120242
	PC Polycarbonate
Socket with earthing pin Double 33°, with increased touch protection, with screwless terminals, 2-pin, 16 A, 250V ~, with connection terminals to IEC 60884-1.	

33° socket, with earthing pin, triple

	
Type	STD-F3 RW3
Colour	Pure white
Pack Piece	1
Weight kg/100 pc.	10.500
Item no.	6120262
	PC Polycarbonate
Socket with earthing pin Triple 33°, with increased touch protection, with screwless terminals, 2-pin, 16 A, 250V ~, with connection terminals to IEC 60884-1.	

0° socket, Switzerland, single

PC

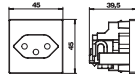

Type	Colour	Pack Piece	Weight kg/100 pc.	Item no.
SKS-CH0 RW1	Pure white	1	3.400	6117200

Socket, single 0°, to Swiss standard (SEV), with screwless terminals, 2-pin, 10 A, 250 V~, type 13, with connection terminals to IEC 60884-1.

0° socket, Denmark, single

PC

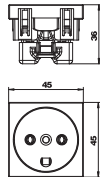

Type	Colour	Pack Piece	Weight kg/100 pc.	Item no.
SKS-DK0 RW1	Pure white	12	3.050	6117202

Socket, single 0°, to Danish standard, with increased touch protection, with screw terminals, 2-pin, 16 A 250 V~, with connection terminals to IEC 60884-1.

0° socket, Denmark, single, IT-encoded

PC

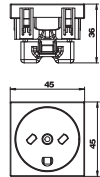

Type	Colour	Pack Piece	Weight kg/100 pc.	Item no.
SKS-DKE0 RW1	Pure white	12	3.050	6117203

Socket, single 0°, to Danish standard, encoded for IT power circuit, with screw terminals, 2-pin, 16 A 250 V~, with connection terminals to IEC 60884-1.

0° socket, British Standard, single

PC

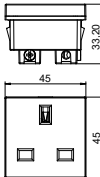

Type	Colour	Pack Piece	Weight kg/100 pc.	Item no.
STD-BS0 RW1	Pure white	1	4.000	6120722

Socket, single 0°, British Standard, conforms to BS 1363, with increased touch protection, with screw terminals, 2-pin, 13 A, 250 V~.

0° socket with switch, British Standard, single

PC

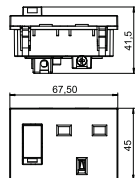

Type	Colour	Pack Piece	Weight kg/100 pc.	Item no.
STD-BS0G RW1.5	Pure white	1	6.000	6120724

Socket, single 0°, with switch, British Standard, conforms to BS 1363, with increased touch protection, with screw terminals, 2-pin, 13 A, 250 V~.

AR45 socket unit, single

Type	SDE-RW D0RW1	SDE-RW D0GN1	SDE-RW D0RT1
Colour	Pure white	Mint green	Signal red
Pack Piece	4	4	4
Weight kg/100 pc.	10.700	10.700	10.700
Item no.	6119401	6119402	6119403

PC Polycarbonate

Pre-terminated socket unit without labelling panel, suitable for installation in Rapid 80 device installation trunking systems.

Socket unit, consisting of:

- Accessory mounting box, single, type 71GD8-2.
- Protective contact socket, single, 0° connection direction, colour: see table.
- Cover frame AR45, single, without labelling panel, colour: pure white

AR45 socket unit, double

Type	SDE-RW D0RW2	SDE-RW D0GN2	SDE-RW D0RT2
Colour	Pure white	Mint green	Signal red
Pack Piece	2	2	2
Weight kg/100 pc.	19.000	19.000	19.000
Item no.	6119407	6119408	6119409

PC Polycarbonate

Pre-terminated socket unit without labelling panel, suitable for installation in Rapid 80 device installation trunking systems.

Socket unit, consisting of:

- Service outlet, double, type 71GD13
- Protective contact socket, double, 0° connection direction, colour: see table
- Cover frame AR45, double, without labelling panel, colour: pure white

AR45 socket unit, triple

Type	SDE-RW D0RW3	SDE-RW D0GN3	SDE-RW D0RT3
Colour	Pure white	Mint green	Signal red
Pack Piece	2	2	2
Weight kg/100 pc.	23.300	23.300	23.300
Item no.	6119414	6119415	6119413

PC Polycarbonate

Pre-terminated socket unit without labelling panel, suitable for installation in Rapid 80 device installation trunking systems.

Socket unit, consisting of:

- Service outlet, triple, type 71GD9-2
- Protective contact socket, triple, 0° connection direction, colour: see table
- Cover frame AR45, triple, without labelling panel, colour: pure white

AR45 socket unit, single, with labelling panel for horizontal device installation

	Type	SDE-RW D0RW1B	SDE-RW D0GN1B
Colour	Pure white	Mint green	Signal red
Pack Piece	4	4	4
Weight kg/100 pc.	10.700	10.700	10.700
Item no.	6119421	6119422	6119423

PC Polycarbonate

Pre-terminated socket unit with labelling panel, suitable for installation in Rapid 80 device installation trunking systems.

Socket unit, consisting of:

- Accessory mounting box, single, type 71GD8-2
- Protective contact socket, single, 0° connection direction, colour: see table
- Cover frame AR45, single, with labelling panel, type AR45-BF..., colour: pure white

AR45 socket unit, double, with labelling panel for horizontal device installation

	Type	SDE-RW D0RW2B	SDE-RW D0GN2B
Colour	Pure white	Mint green	Signal red
Pack Piece	2	2	2
Weight kg/100 pc.	19.000	19.000	19.000
Item no.	6119427	6119428	6119429

PC Polycarbonate

Pre-terminated socket unit with labelling panel, suitable for installation in Rapid 80 device installation trunking systems.

Socket unit, consisting of:

- Accessory mounting box, double, type 71GD13
- Protective contact socket, double, 0° connection direction, colour: see table
- Cover frame AR45, double, with labelling panel, type AR45-BF..., colour: pure white

AR45 socket unit, triple, with labelling panel for horizontal device installation

	Type	SDE-RW D0RW3B	SDE-RW D0GN3B
Colour	Pure white	Mint green	Signal red
Pack Piece	2	2	2
Weight kg/100 pc.	23.300	23.300	23.300
Item no.	6119433	6119434	6119435

PC Polycarbonate

Pre-terminated socket unit with labelling panel, suitable for installation in Rapid 80 device installation trunking systems.

Socket unit, consisting of:

- Accessory mounting box, triple, type 71GD9-2
- Protective contact socket, triple, 0° connection direction, colour: see table
- Cover frame AR45, triple, with labelling panel, type AR45-BF..., colour: pure white

PA

CEE socket unit, single, 16 A

Type	Colour	Pack Piece	Weight kg/100 pc.	Item no.
71GDCEE16	Graphite black	1	31.100	6119483

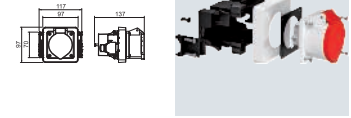

Accessory mounting box for the installation of a 3 or 5-pole CEE socket, 16 A or 32 A.

Scope of delivery:

- 1 front-locking accessory mounting box for 4-point fastening track of 52 x 52 mm to 70 x 70 mm
- 1 cover frame in pure white for hiding the fastening technology
- 2 external strain reliefs for jacketed cables of up to Ø 18 mm
- 2 sash locks for optional fastening to trunking bases with C rail
- 1 CEE socket 16 A with mounting accessories

PA

CEE socket unit, single, 32 A

Type	Colour	Pack Piece	Weight kg/100 pc.	Item no.
71GDCEE32	Graphite black	1	37.200	6119485

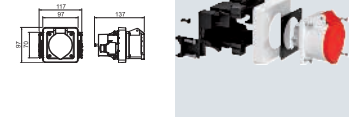

Accessory mounting box for the installation of a 3 or 5-pole CEE socket, 16 A or 32 A.

Scope of delivery:

- 1 front-locking accessory mounting box for 4-point fastening track of 52 x 52 mm to 70 x 70 mm
- 1 cover frame in pure white for hiding the fastening technology
- 2 external strain reliefs for jacketed cables of up to Ø 18 mm
- 2 sash locks for optional fastening to trunking bases with C rail
- 1 CEE socket 32 A with mounting accessories

USB charging device, Modul 45

USB charging device



Type	MTG-2UC2.1 RW1	MTG-2UC2.1 SWGR1	MTG-2UC2.1 AL1
Colour	Pure white	Black-grey	Aluminium-painted
Pack Piece	1	1	1
Weight kg/100 pc.	6.162	5.500	5.500
Item no.	6105300	6105302	6105304

PC Polycarbonate

USB charging device with two USB type A sockets, for charging 1–2 mobile devices, maximum charging current 1x 2,100 mA or 2x 1,050 mA.

Equipotential bonding socket

Equipotential bonding socket, 1 module, straight outlet



Type	PAD-ID6 RW1	PAD-ID6 SWGR1	PAD-ID6 AL1
Colour	Pure white	Black-grey	Aluminium-painted
Pack Piece	1	1	1
Weight kg/100 pc.	5.000	5.000	5.000
Item no.	6120003	6120001	6120005

PC Polycarbonate

Equipotential bonding socket to DIN 42801, socket in black with green-yellow colour ring, cable connection to rear with M6 screw bolt, including two nuts, washers and a serrated washer.

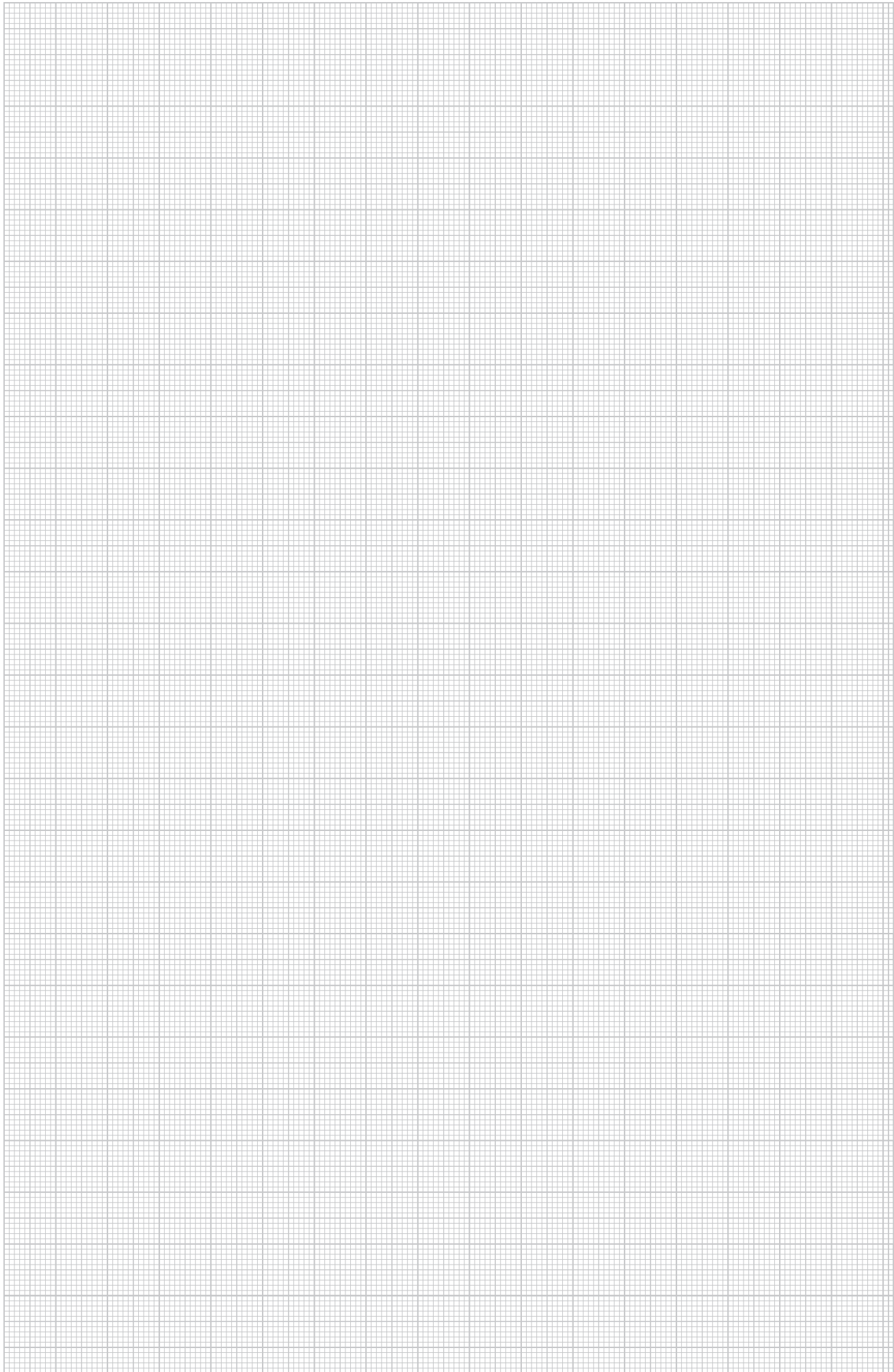

Strain reliefs

Strain relief for Modul 45® sockets 0°

PC

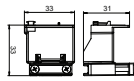

Type	Colour	Pack	Weight	Item no.
		Piece	kg/100 pc.	
ZL-STD 0	Black	1	1.800	6120782

Strain relief for Modul 45 sockets, type STD, connectable at side, for the fastening of a 3-core cable, max. Ø 10 mm, suitable for protective contact sockets at direction of insertion 0° and sockets with earthing pin at direction of insertion 0°.

Encoding pin

PC

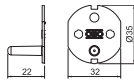

Type	Colour	Pack	Weight	Item no.
		Piece	kg/100 pc.	
CST-STD K	Black-grey	10	0.200	6120797

Encoding pin as socket attachment for the use of encoded sockets, type STD.

Cable outlet

PC

Cable outlet for 3–11 mm cross-section

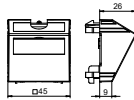

Type	Colour	Pack	Weight	Item no.
		Piece	kg/100 pc.	
KAL-K11 RW1	Pure white	1	3.500	6117420
KAL-K11 SWGR1	Black-grey	1	3.500	6117421
KAL-K11 AL1	Aluminium-painted	1	3.500	6117422

Two-part cable outlet with labelling panel, consisting of a cable support with strain relief and a cover. The strain relief is suited for cable cross-sections of 3 to 11 mm. The locking fastening is suitable for horizontal and vertical installation in the system environment.

Blanking covers

PC

Blanking cover with labelling panel, 1/2 module

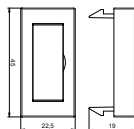

Type	Colour	Pack	Weight	Item no.
		Piece	kg/100 pc.	
ADP-BF RW0.5	Pure white	1	0.400	6117410
ADP-BF SWGR0.5	Black-grey	1	0.400	6117411
ADP-BF AL0.5	Aluminium-painted	1	0.400	6117412

Blanking cover with labelling panel, suited for labelling devices in Rapid 45 device installation trunking systems and ISS service poles with a 45 mm system opening.

Blanking cover, 1/2 module

Type	Colour	Pack Piece	Weight kg/100 pc.	Item no.
ADP-B RW0.5	Pure white	10	0.400	6117414
ADP-B SWGR0.5	Black-grey	10	0.400	6117415
ADP-B AL0.5	Aluminium-painted	1	0.400	6117416

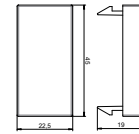

Blanking cover for closing off empty spaces for a half device (1/2 module).

Blanking cover, 1 module

Type	Colour	Pack Piece	Weight kg/100 pc.	Item no.
ADP-B RW1	Pure white	10	0.800	6117406
ADP-B SWGR1	Black-grey	10	0.800	6117407
ADP-B AL1	Aluminium-painted	1	0.800	6117408

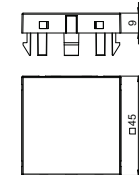

Blanking cover for closing off empty spaces for a device (one module).

Device support

St FS

Device support for CEE installation, system length 165 mm, without CEE

Type	Pack Piece	Weight kg/100 pc.	Item no.
GT2CEE	1	51.000	7407665

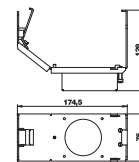

Device support of nominal size 2 for the installation of a CEE plug connection 16 A or 32 A for installation in service outlets and cassettes of nominal size 2, 4, 6 and R7. Device support with protective housing and strain relief. Required minimum installation depth: 190 mm when using a straight connector and 160 mm when an angled connector is used.

St FS

Device support for CEE installation, system length 165 mm, with CEE

Type	Pack Piece	Weight kg/100 pc.	Item no.
GT2 CEE16	1	69.000	7407663

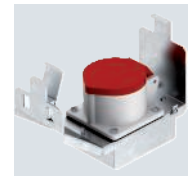
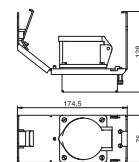

Device support of nominal size 2 with a CEE plug connection 16 A for installation in service outlets and cassettes of nominal size 2, 4, 6 and R7. Device support with protective housing and strain relief. Required minimum installation depth: 190 mm when using a straight connector and 160 mm when an angled connector is used.

St FS

Device support for CEE installation, system length 208 mm, without CEE

Type	Pack Piece	Weight kg/100 pc.	Item no.
GT3 CEE	1	57.000	7407669

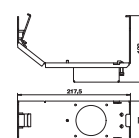

Device support of nominal size 3 for the installation of a CEE plug connection 16 A or 32 A for installation in service outlets and cassettes of nominal size R7, 9 and R9. Device support with protective housing and strain relief. Required minimum installation depth: 190 mm when using a straight connector and 160 mm when an angled connector is used.

Device support

Device support for CEE installation, system length 208 mm, with CEE

St FS

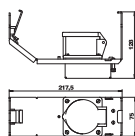
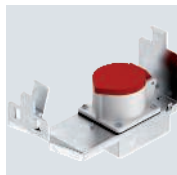

Type	Pack Piece	Weight kg/100 pc.	Item no.
GT3 CEE16	1	75.000	7407667

Device support of nominal size 3 with a CEE plug connection 16 A for installation in service outlets and cassettes of nominal sizes R7, 9 and R9. Device support with protective housing and strain relief. Required minimum installation depth: 190 mm when using a straight connector and 160 mm when an angled connector is used.

Separating retainer

Separating retainer for module support, vertical

PA

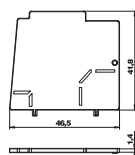
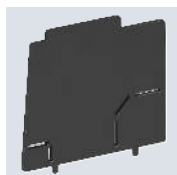

Type	Colour	Pack Piece	Weight kg/100 pc.	Item no.
MT45V TW	Graphite black	10	0.343	7408693

To separate different current types in mounting supports for vertical installation of Modul 45 devices.

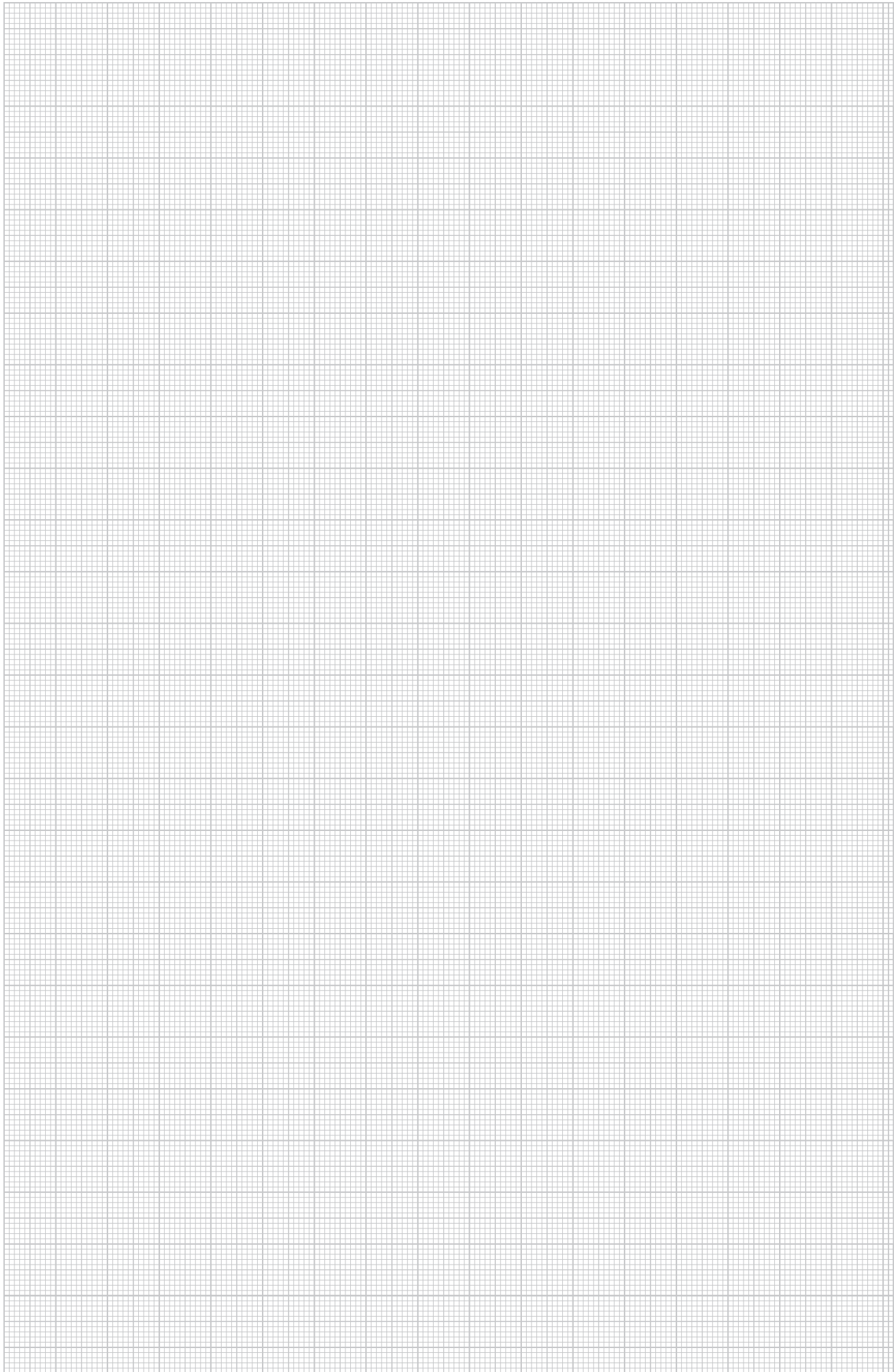

One-way/changeover switch, 1/2 module

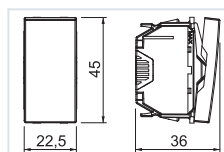

Type	WS-UB RW0.5	WS-UB SWGR0.5	WS-UB AL0.5
Colour	Pure white	Black-grey	Aluminium-painted
Pack Piece	1	1	1
Weight kg/100 pc.	1.800	1.800	1.800
Item no.	6120920	6120922	6120924

PC Polycarbonate

Changeover switch 1-pin, 10 A, 250 V~, with screwless terminals.

One-way/changeover switch with warning lamp, 1/2 module

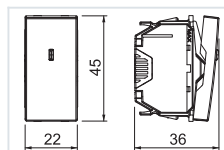

Type	WS-UKL RW0.5	WS-UKL SWGR0.5	WS-UKL AL0.5
Colour	Pure white	Black-grey	Aluminium-painted
Pack Piece	1	1	1
Weight kg/100 pc.	1.800	1.800	1.800
Item no.	6120926	6120928	6120930

PC Polycarbonate

Changeover switch with LED element as a control light, 1-pole, 10 A, 250 V~, with screwless terminals.

One-way/changeover switch, 1 module

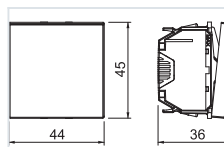

Type	WS-UB RW1	WS-UB SWGR1	WS-UB AL1
Colour	Pure white	Black-grey	Aluminium-painted
Pack Piece	1	1	1
Weight kg/100 pc.	2.600	2.600	2.300
Item no.	6120932	6120934	6120936

PC Polycarbonate

Changeover switch 1-pin, 10 A, 250 V~, with screwless terminals.

One-way/changeover switch with warning lamp, 1 module

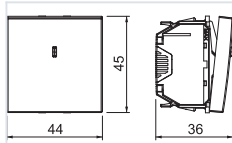

Type	WS-UKL RW1	WS-UKL SWGR1	WS-UKL AL1
Colour	Pure white	Black-grey	Aluminium-painted
Pack Piece	1	1	1
Weight kg/100 pc.	2.300	2.300	2.300
Item no.	6120938	6120940	6120942

PC Polycarbonate

Changeover switch with LED element as a control light, 1-pole, 10 A, 250 V~, with screwless terminals.

Roller blind switch, 1 module

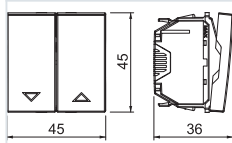

Type	RS-BS RW1	RS-BS SWGR1	RS-BS AL1
Colour	Pure white	Black-grey	Aluminium-painted
Pack Piece	1	1	1
Weight kg/100 pc.	3.700	3.700	3.700
Item no.	6120950	6120952	6120954

PC Polycarbonate

Roller blind switch with electrical and mechanical lock, 1-pin, 10 A, 250 V~, with screwless terminals.

Roller blind button, 1 module

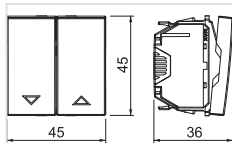

Type	RT-BS RW1	RT-BS SWGR1	RT-BS AL1
Colour	Pure white	Black-grey	Aluminium-painted
Pack Piece	1	1	1
Weight kg/100 pc.	3.700	3.700	3.700
Item no.	6120980	6120982	6120984

PC Polycarbonate

Roller blind button with electrical locking, 1-pin, 10 A, 250 V~, with screwless terminals.

Changeover switch, 1/2 module

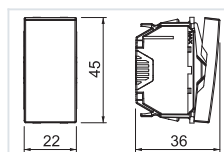

Type	TA-WB RW0.5	TA-WB SWGR0.5	TA-WB AL0.5
Colour	Pure white	Black-grey	Aluminium-painted
Pack Piece	1	1	1
Weight kg/100 pc.	1.800	1.800	1.800
Item no.	6120960	6120962	6120964

PC Polycarbonate

Changeover switch, 1-pin, 10 A, 250 V~, with screwless terminals.

Changeover switch, 1 module

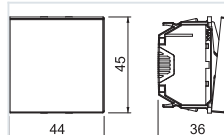

Type	TA-WB RW1	TA-WB SWGR1	TA-WB AL1
Colour	Pure white	Black-grey	Aluminium-painted
Pack Piece	1	1	1
Weight kg/100 pc.	3.300	3.300	3.300
Item no.	6120966	6120968	6120970

PC Polycarbonate

Changeover switch, 1-pin, 10 A, 250 V~, with screwless terminals.

Adapter for switch installation rotated through 90°

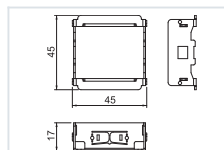



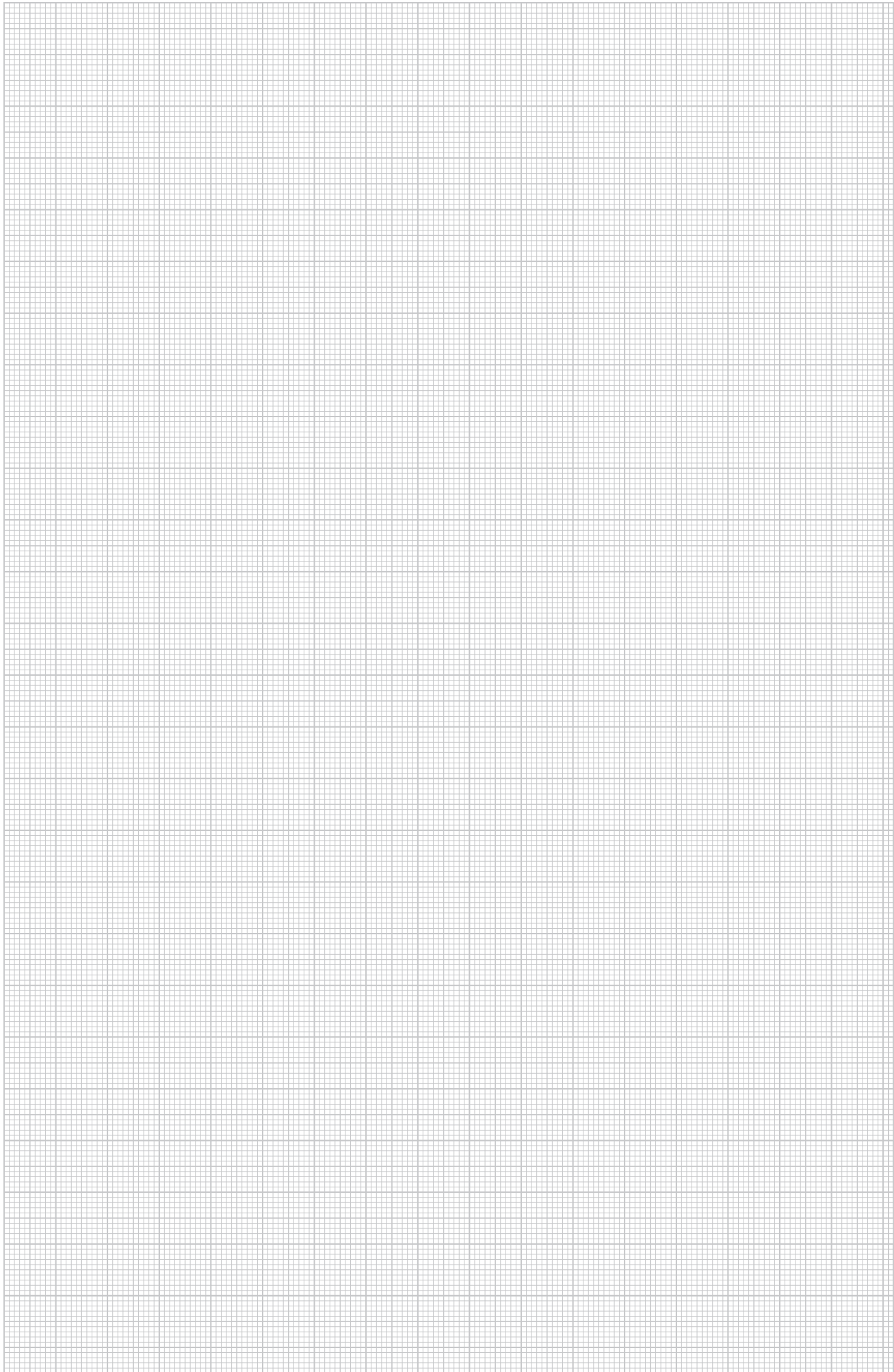

Type	AD-90G M45-1
Pack Piece	1
Weight kg/100 pc.	2.200
Item no.	6120992

St Steel

The adapter allows switch installation rotated through 90° in, for example, service poles with a 45 mm track or Rapid 45. Suitable for all switches and buttons in one module width (45 x 45 mm).

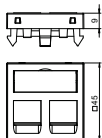

Data technology support, 1 module, straight outlet, type RM

			
Colour	Pure white	Black-grey	Aluminium-painted
Pack Piece	1	1	1
Weight kg/100 pc.	1.100	1.100	1.100
Item no.	6119292	6119294	6119296

PC Polycarbonate

The type RM data technology support is suitable for accepting the following data connection modules: Types ASM-C5, ASM-C5 G, ASM-C6 and ASM-C6 G; R&M: Cat.5 and Cat.6 modules without support plate.

Data technology support with straight outlet and locking slider to accept two data technology connection modules with RJ45 socket. The locking fastening is suitable for horizontal and vertical installation in the system environment. Type RM has a special module seat and is designed for indirect fastening of the data connection modules in the mounting opening.

Data technology support, 1 module, slanting outlet, type RM





			
Colour	Pure white	Black-grey	Aluminium-painted
Pack Piece	1	1	1
Weight kg/100 pc.	2.900	2.900	2.900
Item no.	6119298	6119300	6119302

PC Polycarbonate

The type RM data technology support is suitable for accepting the following data connection modules: Types ASM-C5, ASM-C5 G, ASM-C6 and ASM-C6 G; R&M: Cat.5 and Cat.6 modules without support plate.

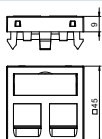
Data technology support with slanting outlet and locking slider to accept two data technology connection modules with RJ45 socket. The locking fastening is suitable for horizontal and vertical installation in the system environment. Type RM has a special module seat and is designed for indirect fastening of the data connection modules in the mounting opening.

Data technology support, 1 module, straight outlet, type C

			
Colour	Pure white	Black-grey	Aluminium-painted
Pack Piece	1	1	1
Weight kg/100 pc.	1.100	1.100	1.100
Item no.	6119214	6119216	6119218

PC Polycarbonate

The type C data technology support is suitable for accepting the following data connection modules: BTR (Keystone design): Cat. 6A module and UAE module; Coming: modules with Keystone seat; CobiNet: CobiDat KS module; Dätwyler: KS-T, KS-TS, MS-K and KU-T; EKV: E-Stone; Harting: Prelink Keystone Cat. 6A; Fixlink Keystone Cat. 6A; Komos: KDM 500 module; Leoni Kerpen: MegaLine-Connect45 Keystone socket modules; OBO: Type ASM-C6A and ASM-C6A G; R&M: Cat. 6A with Keystone fastening; Rutenbeck: UM and UMflex; SETEC: UKJ and XKJ; Telegärtner: AMJ and UMJ.

Data technology support with straight outlet and locking slider to accept two data technology connection modules with RJ45 socket. The locking fastening is suitable for horizontal and vertical installation in the system environment. Type C has a mounting opening of 19.30 x 14.80 mm and is designed for direct fastening of the data connection modules in the mounting opening.

Data technology support, 1 module, slanting outlet, type C

Type	DTS-2C RW1	DTS-2C SWGR1	DTS-2C AL1
Colour	Pure white	Black-grey	Aluminium-painted
Pack Piece	1	1	1
Weight kg/100 pc.	1.500	1.500	1.500
Item no.	6119250	6119252	6119254

PC Polycarbonate

The type C data technology support is suitable for accepting the following data connection modules: BTR (Keystone design): Cat. 6A module and UAE module; Corning: modules with Keystone seat; CobiNet: CobiDat KS module; Dätwyler: KS-T, KS-TS, MS-K and KU-T; EKU: E-Stone; Harting: Prelink Keystone Cat. 6A; Fixlink Keystone Cat. 6A; Komos: KDM 500 module; Leoni Kerpen: MegaLine-Connect45 Keystone socket modules; OBO: Type ASM-C6A and ASM-C6A G; R&M: Cat. 6A with Keystone fastening; Rutenbeck: UM and UMflex; SETEC: UKJ and XKJ; Telegärtner: AMJ and UMJ.

Data technology support with slanting outlet and locking slider to accept two data technology connection modules with RJ45 socket. The locking fastening is suitable for horizontal and vertical installation in the system environment. Type C has a mounting opening of 19.30 x 14.80 mm and is designed for direct fastening of the data connection modules in the mounting opening.

Data technology support, 1 module, straight outlet, type A

Type	DTG-2A RW1	DTG-2A SWGR1	DTG-2A AL1
Colour	Pure white	Black-grey	Aluminium-painted
Pack Piece	1	1	1
Weight kg/100 pc.	1.100	1.100	1.100
Item no.	6119202	6119204	6119206

PC Polycarbonate

The Type A data technology support is suitable for accepting the following data connection modules: AMP TYCO (without dust protection cap): SL Series 110Connect and SL Series Toolless; Brand-Rex: modules with item numbers ending in ...JAKS000CR and ...JAKU002; Nexans: LANmark RJ45 with blue adapter clip, LANmark GG45 with metal clip.

Data technology support with straight outlet and locking slider to accept two data technology connection modules with RJ45 socket. The locking fastening is suitable for horizontal and vertical installation in the system environment. Type A has a mounting opening of 20.10 x 14.80 mm and is designed for direct fastening of the data connection modules in the mounting opening.

Data technology support, 1 module, slanting outlet, type A

Type	DTS-2A RW1	DTS-2A SWGR1	DTS-2A AL1
Colour	Pure white	Black-grey	Aluminium-painted
Pack Piece	1	1	1
Weight kg/100 pc.	2.000	1.500	1.500
Item no.	6119238	6119240	6119242

PC Polycarbonate

The Type A data technology support is suitable for accepting the following data connection modules: AMP TYCO (without dust protection cap): SL Series 110Connect and SL Series Toolless; Brand-Rex: modules with item numbers ending in ...JAKS000CR and ...JAKU002; Nexans: LANmark RJ45 with blue adapter clip, LANmark GG45 with metal clip.

Data technology support with slanting outlet and locking slider to accept two data technology connection modules with RJ45 socket. The locking fastening is suitable for horizontal and vertical installation in the system environment. Type A has a mounting opening of 20.10 x 14.80 mm and is designed for direct fastening of the data connection modules in the mounting opening.

Data technology support, 1 module, straight outlet, type B

	Type	DTG-2B RW1	DTG-2B SWGR1
Colour	Pure white	Black-grey	Aluminium-painted
Pack Piece	1	1	1
Weight kg/100 pc.	1.100	1.100	1.100
Item no.	6119208	6119210	6119212

PC Polycarbonate

The type B data technology support is suitable for accepting the following data connection modules: BTR (module design): Cat. 6A Modul, E-DAT module and UAE module; Dätwyler: MS and MS-N, Leoni Kerpen: VarioKeystone socket module Cat. 6A and MegaLine-Connect100 socket module Cat. 6A and 8C7A.

Data technology support with straight outlet and locking slider to accept two data technology connection modules with RJ45 socket. The locking fastening is suitable for horizontal and vertical installation in the system environment. Type B has a mounting opening of 19.35/21.55 x 14.85 mm and is designed for direct fastening of the data connection modules in the mounting opening.

Data technology support, 1 module, slanting outlet, type B

	Type	DTS-2B RW1	DTS-2B SWGR1
Colour	Pure white	Black-grey	Aluminium-painted
Pack Piece	1	1	1
Weight kg/100 pc.	1.500	1.500	1.500
Item no.	6119244	6119246	6119248

PC Polycarbonate

The type B data technology support is suitable for accepting the following data connection modules: BTR (module design): Cat. 6A Modul, E-DAT module and UAE module; Dätwyler: MS and MS-N, Leoni Kerpen: VarioKeystone socket module Cat. 6A and MegaLine-Connect100 socket module Cat. 6A and 8C7A.

Data technology support with slanting outlet and locking slider to accept two data technology connection modules with RJ45 socket. The locking fastening is suitable for horizontal and vertical installation in the system environment. Type B has a mounting opening of 19.35/21.55 x 14.85 mm and is designed for direct fastening of the data connection modules in the mounting opening.

Data technology support, 1 module, straight outlet, type C, without dust protection slider

	Type	DTG-02C RW1	DTG-02C SWGR1
Colour	Pure white	Black-grey	Aluminium-painted
Pack Piece	1	1	1
Weight kg/100 pc.	1.000	1.000	1.383
Item no.	6119280	6119282	6119284

PC Polycarbonate

The type C data technology support (without dust protection slider) is suitable for accepting the following data connection modules: 3M: Volition K6, K10 and Cat. 6A.

Data technology support with straight outlet and without a locking slider to accept two data technology connection modules with RJ45 socket. The locking fastening is suitable for horizontal and vertical installation in the system environment. Type C has a mounting opening of 19.30 x 14.80 mm and is designed for direct fastening of the data connection modules in the mounting opening.

Data technology support, 1 module, slanting outlet, type C, without dust protection slider



Type	DTS-02C RW1	DTS-02C SWGR1	DTS-02C AL1
Colour	Pure white	Black-grey	Aluminium-painted
Pack Piece	1	1	1
Weight kg/100 pc.	1.400	1.400	1.400
Item no.	6119286	6119288	6119290

PC Polycarbonate

The type C data technology support (without dust protection slider) is suitable for accepting the following data connection modules: 3M: Volition K6, K10 and Cat. 6A.

Data technology support with slanting outlet and without a locking slider to accept two data technology connection modules with RJ45 socket. The locking fastening is suitable for horizontal and vertical installation in the system environment. Type C has a mounting opening of 19.30 x 14.80 mm and is designed for direct fastening of the data connection modules in the mounting opening.

Data technology support, 1 module, straight outlet, type EP



Type	DTG-2EP RW1	DTG-2EP SWGR1	DTG-2EP AL1
Colour	Pure white	Black-grey	Aluminium-painted
Pack Piece	1	1	1
Weight kg/100 pc.	1.100	1.100	1.100
Item no.	6119232	6119234	6119236

PC Polycarbonate

The type EP data technology support is suitable for accepting the following data connection modules: Leoni Kerpen: MegaLine-Connect45 ELine.

Data technology support with straight outlet and locking slider to accept two data technology connection modules with RJ45 socket. The locking fastening is suitable for horizontal and vertical installation in the system environment. Type EP has a special module seat and is designed for indirect fastening of the data connection modules in the mounting opening.

Data technology support, 1 module, slanting outlet, type EP

			
	Type	DTS-2EP RW1	DTS-2EP SWGR1
Colour	Pure white	Black-grey	Aluminium-painted
Pack Piece	1	1	1
Weight kg/100 pc.	1.500	1.500	1.500
Item no.	6119268	6119270	6119272

PC Polycarbonate

The type EP data technology support is suitable for accepting the following data connection modules: Leoni Kerpen: MegaLine-Connect45 ELine.

Data technology support with slanting outlet and locking slider to accept two data technology connection modules with RJ45 socket. The locking fastening is suitable for horizontal and vertical installation in the system environment. Type EP has a special module seat and is designed for indirect fastening of the data connection modules in the mounting opening.

Data technology support, 1 module, straight outlet, type F

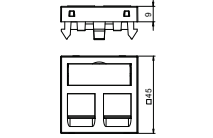
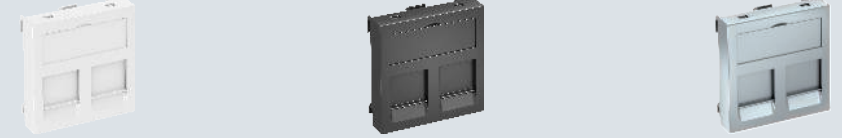
			
	Type	DTG-2F RW1	DTG-2F SWGR1
Colour	Pure white	Black-grey	Aluminium-painted
Pack Piece	1	1	1
Weight kg/100 pc.	1.100	1.100	1.100
Item no.	6119220	6119222	6119224

PC Polycarbonate

The type F data technology support is suitable for accepting the following data connection modules: Avaya/Systemax: M series.

Data technology support with straight outlet and locking slider to accept two data technology connection modules. The locking fastening is suitable for horizontal and vertical installation in the system environment.

Data technology support, 1 module, slanting outlet, type F

			
	Type	DTS-2F RW1	DTS-2F SWGR1
Colour	Pure white	Black-grey	Aluminium-painted
Pack Piece	1	1	1
Weight kg/100 pc.	1.500	1.500	1.500
Item no.	6119256	6119258	6119260

PC Polycarbonate

The type F data technology support is suitable for accepting the following data connection modules: Avaya/Systemax: M series.

Data technology support with slanting outlet and locking slider to accept two data technology connection modules with RJ45 socket. The locking fastening is suitable for horizontal and vertical installation in the system environment. Type F has a special module seat and is designed for indirect fastening of the data connection modules in the mounting opening.

Data technology support, 1 module, straight outlet, type PA

	Type	DTG-2PA RW1	DTG-2PA SWGR1
Colour	Pure white	Black-grey	Aluminium-painted
Pack Piece	1	1	1
Weight kg/100 pc.	1.100	1.100	1.100
Item no.	6119226	6119228	6119230

PC Polycarbonate

The type PA data technology support is suitable for accepting the following data connection modules: Panduit: Mini-Com.

Data technology support with straight outlet and locking slider to accept two data technology connection modules with RJ45 socket. The locking fastening is suitable for horizontal and vertical installation in the system environment. Type PA has a special module seat and is designed for indirect fastening of the data connection modules in the mounting opening.

Data technology support, 1 module, slanting outlet, type PA

	Type	DTS-2PA RW1	DTS-2PA SWGR1
Colour	Pure white	Black-grey	Aluminium-painted
Pack Piece	1	1	1
Weight kg/100 pc.	1.500	1.500	1.500
Item no.	6119262	6119264	6119266

PC Polycarbonate

The type PA data technology support is suitable for accepting the following data connection modules: Panduit: Mini-Com.

Data technology support with slanting outlet and locking slider to accept two data technology connection modules with RJ45 socket. The locking fastening is suitable for horizontal and vertical installation in the system environment. Type PA has a special module seat and is designed for indirect fastening of the data connection modules in the mounting opening.

Data technology support, 1 module, straight outlet, type LE

	Type	DTG-02LE RW1	DTG-02LE SWGR1
Colour	Pure white	Black-grey	Aluminium-painted
Pack Piece	1	1	1
Weight kg/100 pc.	0.900	0.900	0.900
Item no.	6119304	6119306	6119308

PC Polycarbonate

The type LE data technology support is suitable for accepting the following data connection modules: LexCom/Schneider: LexCom 125, LexCom 250 and LexCom 500.

Data technology support with straight outlet and without a locking slider to accept two data technology connection modules with RJ45 socket. The locking fastening is suitable for horizontal and vertical installation in the system environment. Type LE has a special module seat and is designed for indirect fastening of the data connection modules in the mounting opening.

D-Sub9 connection, 1 module, straight outlet, as screw connection



Type	MTG-DB9 S RW1	MTG-DB9 S SWGR1	MTG-DB9 S AL1
Colour	Pure white	Black-grey	Aluminium-painted
Pack Piece	1	1	1
Weight kg/100 pc.	2.400	2.400	2.400
Item no.	6104634	6104637	6104640

PC Polycarbonate

Multimedia support with one D-Sub9 connection socket, straight cable outlet, with labelling panel, D-Sub9 socket (RS232) with screw connection. Support plate with locking fastening, suitable for horizontal and vertical installation in the system environment.

D-Sub9 connection, 1 module, slanting outlet, as screw connection



Type	MTS-DB9 S RW1	MTS-DB9 S SWGR1	MTS-DB9 S AL1
Colour	Pure white	Black-grey	Aluminium-painted
Pack Piece	1	1	1
Weight kg/100 pc.	2.600	2.600	2.600
Item no.	6104646	6104649	6104652

PC Polycarbonate

Multimedia support with one D-Sub9 connection socket, slanting cable outlet, with labelling panel, D-Sub9 socket (RS232) with screw connection. Support plate with locking fastening, suitable for horizontal and vertical installation in the system environment.

D-Sub9 connection, 1 module, straight outlet, with connection cable



Type	MTG-DB9 F RW1	MTG-DB9 F SWGR1	MTG-DB9 F AL1
Colour	Pure white	Black-grey	Aluminium-painted
Pack Piece	1	1	1
Weight kg/100 pc.	5.200	5.200	5.200
Item no.	6104682	6104685	6104688

PC Polycarbonate

Multimedia support with one D-Sub9 connection socket, straight cable outlet, with labelling panel, short D-Sub9 connection cable (RS232), socket-socket version. Support with locking fastening, suitable for horizontal and vertical installation in the system environment.

D-Sub9 connection, 1 module, slanting outlet, with connection cable

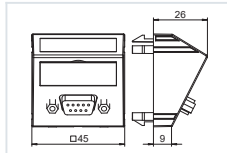

Type	MTS-DB9 F RW1	MTS-DB9 F SWGR1	MTS-DB9 F AL1
Colour	Pure white	Black-grey	Aluminium-painted
Pack Piece	1	1	1
Weight kg/100 pc.	5.400	5.400	5.400
Item no.	6104694	6104697	6104700

PC Polycarbonate

Multimedia support with one D-Sub9 connection socket, slanting cable outlet, with labelling panel, short D-Sub9 connection cable (RS232), socket-socket version. Support with locking fastening, suitable for horizontal and vertical installation in the system environment.

USB 2.0/3.0 connection, 1 module, straight outlet, as screw connection

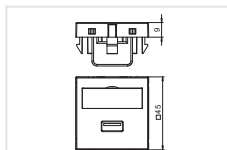

Type	MTG-U3A S RW1	MTG-U3A S SWGR1	MTG-U3A S AL1
Colour	Pure white	Black-grey	Aluminium-painted
Pack Piece	1	1	1
Weight kg/100 pc.	2.500	2.500	2.500
Item no.	6104874	6104877	6104880

PC Polycarbonate

Multimedia support with one USB 3.0 connection socket, straight cable outlet, with labelling panel, USB 3.0 type A socket with screw connection. Support plate with locking fastening, suitable for horizontal and vertical installation in the system environment.

USB 2.0/3.0 connection, 1 module, slanting outlet, as screw connection

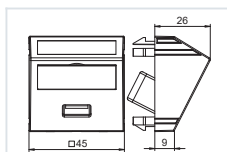

Type	MTS-U3A S RW1	MTS-U3A S SWGR1	MTS-U3A S AL1
Colour	Pure white	Black-grey	Aluminium-painted
Pack Piece	1	1	1
Weight kg/100 pc.	2.700	2.700	2.700
Item no.	6104886	6104889	6104892

PC Polycarbonate

Multimedia support with one USB 3.0 connection socket, slanting cable outlet, with labelling panel, USB 3.0 type A socket with screw connection. Support plate with locking fastening, suitable for horizontal and vertical installation in the system environment.

USB 2.0/3.0 connection, 1 module, straight outlet, with connection cable



Type	MTG-U3A F RW1	MTG-U3A F SWGR1	MTG-U3A F AL1
Colour	Pure white	Black-grey	Aluminium-painted
Pack Piece	1	1	1
Weight kg/100 pc.	6.000	6.000	6.000
Item no.	6104922	6104925	6104928

PC Polycarbonate

Multimedia support with one USB 3.0 connection socket, straight cable outlet, with labelling panel, short USB 3.0 type A connection cable, socket-socket version. Support plate with locking fastening, suitable for horizontal and vertical installation in the system environment.

USB 2.0/3.0 connection, 1 module, slanting outlet, with connection cable



Type	MTS-U3A F RW1	MTS-U3A F SWGR1	MTS-U3A F AL1
Colour	Pure white	Black-grey	Aluminium-painted
Pack Piece	1	1	1
Weight kg/100 pc.	6.200	6.200	6.200
Item no.	6104934	6104937	6104940

PC Polycarbonate

Multimedia support with one USB 3.0 connection socket, slanting cable outlet, with labelling panel, short USB 3.0 type A connection cable, socket-socket version. Support plate with locking fastening, suitable for horizontal and vertical installation in the system environment.

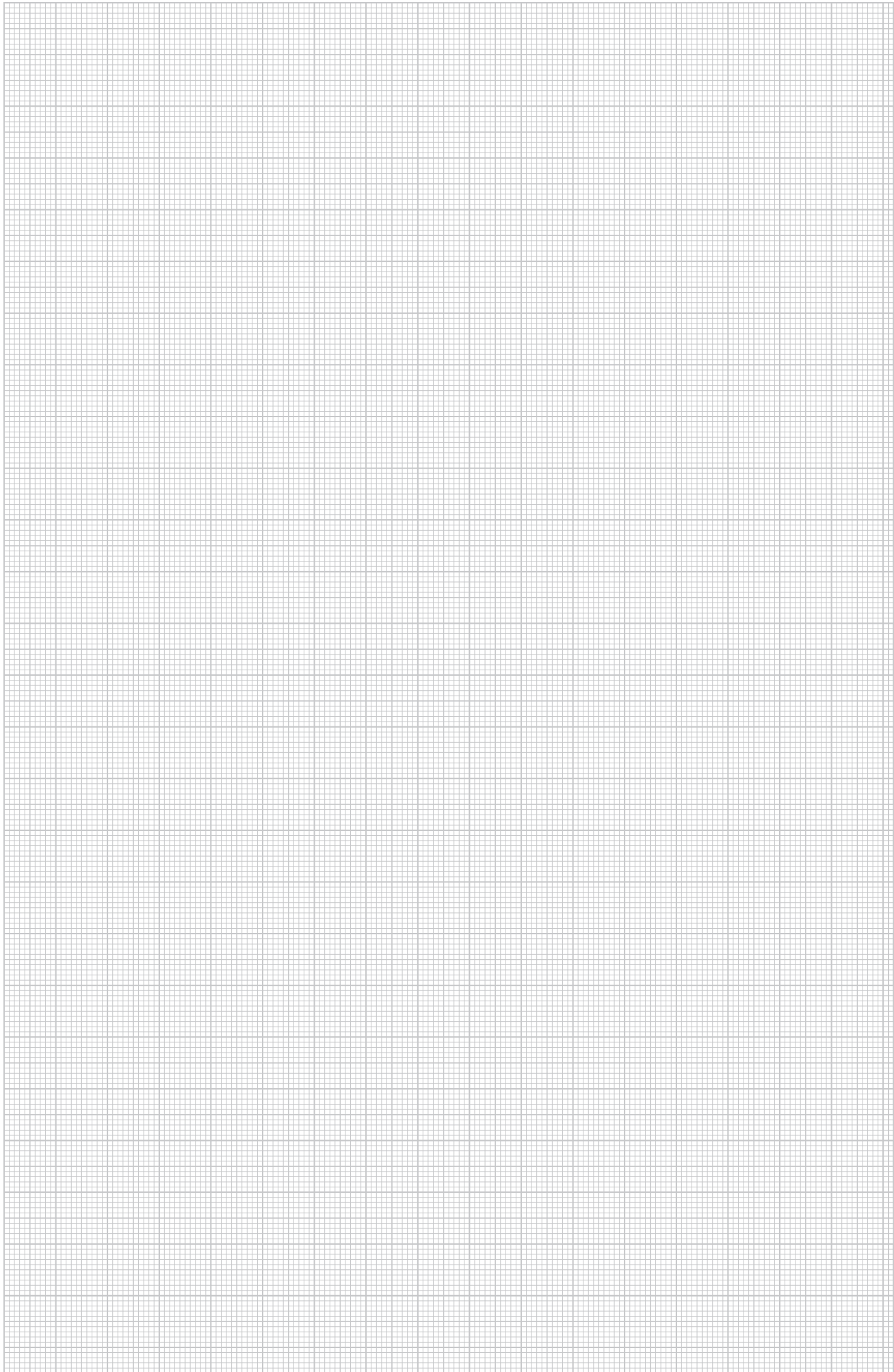

Mounting support

Mounting support for data technology connection sockets, system length 165 mm

St FS

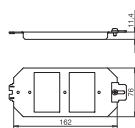

Type	Pack Piece	Weight kg/100 pc.	Item no.
MTU 2	1	11.400	7407836

Mounting support for installation of two cover plates and strain relief. Use instead of a UT3 mounting box.

Mounting support for data technology connection sockets, system length 208 mm

St FS

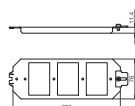

Type	Pack Piece	Weight kg/100 pc.	Item no.
MTU 3	1	14.470	7407840

Mounting support for installation of three cover plates and strain relief. Use instead of a UT4 mounting box.

Strain reliefs

Strain relief for mounting support

St FS

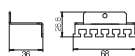

Type	Pack Piece	Weight kg/100 pc.	Item no.
MTU ZE	1	3.520	7407844

For mounting on the MTU 2 and MTU 3 mounting supports for strain relief of incoming connection cables.

Support plates

Support plate 2 x type A for mounting support

VA

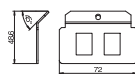
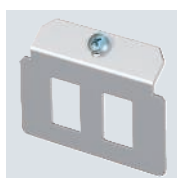

Type	Pack Piece	Weight kg/100 pc.	Item no.
MTM 2A	1	3.680	7407780

Support plate to accept two data connection modules of the following types: AMP TYCO: Standard 110Connect, SL series 110Connect and Toolless, AMP-Twist; Brand-Rex: unshielded; GG45; TKM RJ MOD; Nexans: LANmark with Adapter Clip; Siemon CAT6.
Dimensions of a mounting opening in mm: 20.10 x 14.80.

Support plate 3 x type A for mounting support

VA

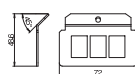
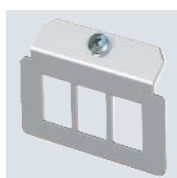

Type	Pack Piece	Weight kg/100 pc.	Item no.
MTM 3A	1	3.320	7407820

Support plate to accept three data connection modules of the following types: AMP TYCO: SL series 110Connect and Toolless, AMP-Twist; Brand-Rex: unshielded; GG45; TKM RJ MOD; Nexans: LANmark with Adapter Clip.
Dimensions of a mounting opening in mm: 20.10 x 14.80.



VA

Support plate 2 x type B for mounting support

Type	Pack Piece	Weight kg/100 pc.	Item no.
MTM 2B	1	2.600	7407784

Support plate to accept two connection modules for data connection modules of the following types BTR: E-DAT; Dätwyler: MS and MS-N; Kerpen: VarioKeystone.
Dimensions of a mounting opening in mm: 19.35/21.55 x 14.85.

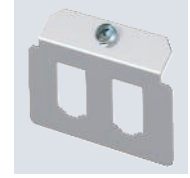
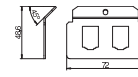

VA

Support plate 3 x type B for mounting support

Type	Pack Piece	Weight kg/100 pc.	Item no.
MTM 3B	1	2.400	7407824

Support plate to accept three connection sockets for data connection modules of the following types BTR: E-DAT; Dätwyler: MS and MS-N; Kerpen: VarioKeystone.
Dimensions of a mounting opening in mm: 19.35/21.55 x 14.85.

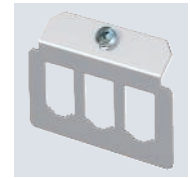
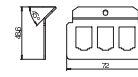

VA

Support plate 2 x type C for mounting support

Type	Pack Piece	Weight kg/100 pc.	Item no.
MTM 2C	1	3.820	7407788

Support plate to accept two data connection modules of the following types: Brand-Rex: shielded; EKU: E-Stone; Dätwyler: KS-T, MS-K and KU-T module; R&M: Snap-In and Keystone; Rutenbeck: UM and UMflex; SETEC: MKJ, UKJ and XKJ; Siemon TERA; Telegärtner: AMJ and UMJ; 3M: CAT6 and CAT6A.
Dimensions of a mounting opening in mm: 19.30 x 14.80.

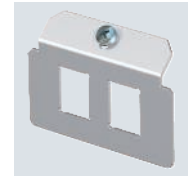
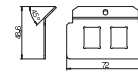

VA

Support plate 3 x type C for mounting support

Type	Pack Piece	Weight kg/100 pc.	Item no.
MTM 3C	1	3.360	7407828

Support plate to accept three data connection modules of the following types: Brand-Rex: shielded; EKU: E-Stone; Dätwyler: KS-T, MS-K and KU-T module; R&M: Snap-In and Keystone; Rutenbeck: UM and UMflex; SETEC: UKJ and XKJ; Siemon TERA; Telegärtner: AMJ and UMJ; 3M: CAT6 and CAT6A.
Dimensions of a mounting opening in mm: 19.30 x 14.80.

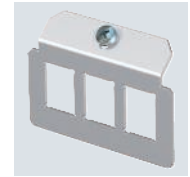
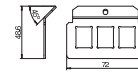

VA

Support plate 1 x type D for mounting support

Type	Pack Piece	Weight kg/100 pc.	Item no.
MTM 1D	1	4.050	7407768

Support plate to accept a data, audio or video technology connection socket, type D-Sub 9.

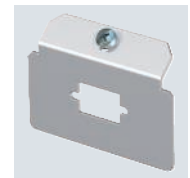
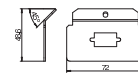

Support plate 2 x type D for mounting support

VA

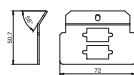
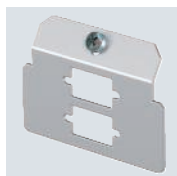

Type
MTM 2D

Pack Piece	Weight kg/100 pc.	Item no.
1	3.400	7407790

Support plate to accept two data, audio or video technology connection sockets, type D-Sub 9.

Support plate 3 x type E for mounting support

VA

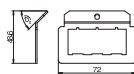
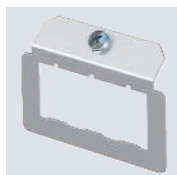

Type
MTM 3E

Pack Piece	Weight kg/100 pc.	Item no.
1	2.320	7407832

Support plate to accept three data connection modules, type Corning.
Dimensions of a mounting opening in mm: 22.80 x 18.00.

Support plate 3 x type F for mounting support

VA

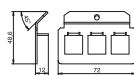
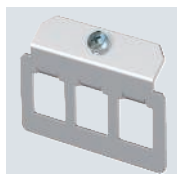

Type
MTM 3F

Pack Piece	Weight kg/100 pc.	Item no.
1	3.400	7407833

Support plate to accept three data connection modules, type Avaya/Systemax: M series.
Dimensions of a mounting opening in mm: 17.40 x 16.60.

Support plate 2 x type F for mounting support

VA

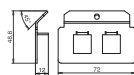
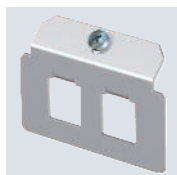

Type
MTM 2F

Pack Piece	Weight kg/100 pc.	Item no.
1	4.030	7407792

Support plate to accept two data connection modules, type Avaya/Systemax: M series.
Dimensions of a mounting opening in mm: 17.40 x 16.60.

Support plate 2 x type H for mounting support

VA

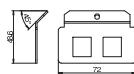
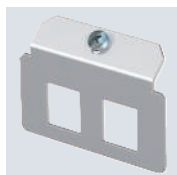

Type
MTM 2H

Pack Piece	Weight kg/100 pc.	Item no.
1	2.850	7407800

Support plate to accept two data connection modules, type 3M.
Dimensions of a mounting opening in mm: 17.90 x 17.00.

VA

Support plate 1 x type K for mounting support

Type	Pack Piece	Weight kg/100 pc.	Item no.
MTM 1K	1	3.120	7407776

Support plate for installation of one connection socket for audio/video systems of type XLR SPEAK_ON, Type D.

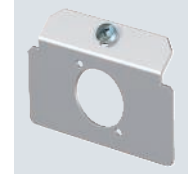
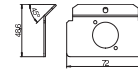

VA

Support plate 2 x type K for mounting support

Type	Pack Piece	Weight kg/100 pc.	Item no.
MTM 2K	1	3.760	7407804

Support plate for installation of two connection sockets for audio/video systems of type XLR SPEAK_ON, Type D.

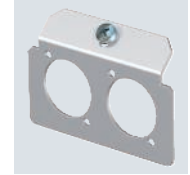
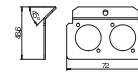

VA

Support plate 2 x type L for mounting support

Type	Pack Piece	Weight kg/100 pc.	Item no.
MTM 2L	1	3.760	7407808

Support plate to accept two pass-through sockets, type LWL SCDuplex.
Dimensions of a mounting opening in mm: 9.70 x 26.00.

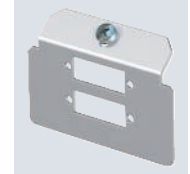
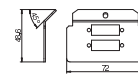

VA

Support plate 2 x type LE for mounting support

Type	Pack Piece	Weight kg/100 pc.	Item no.
MTM 2LE	1	3.300	7407798

Support plate to accept two data connection modules of the following types: LexCom 125 and 250.
Dimensions of a mounting opening in mm: 18.30 x 17.20.

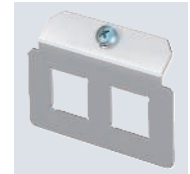
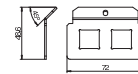

VA

Support plate 2 x type M for mounting support

Type	Pack Piece	Weight kg/100 pc.	Item no.
MTM 2M	1	4.290	7407812

Support plate to accept two pass-through sockets, type LWL ST.

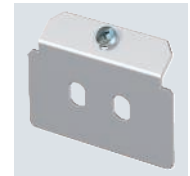
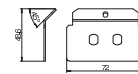

Support plates

Support plate 2 x type N for mounting support

VA

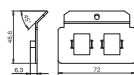
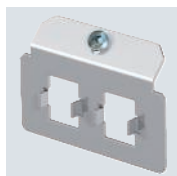

Type
MTM 2N

Pack Piece	Weight kg/100 pc.	Item no.
1	4.290	7407816

Support plate to accept two data connection sockets, type Krone Modul.
Dimensions of a mounting opening in mm: 19.40 x 14.90.

Support plate 2 x type P for mounting support

St FS

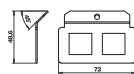
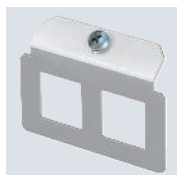

Type
MTM 2P

Pack Piece	Weight kg/100 pc.	Item no.
1	2.600	7407817

Support plate to accept two data connection sockets, type Panduit in combination with Panduit adapter CMNZABL-X or CMNZAWH-X.
Dimensions of a mounting opening in mm: 19.8 x 21.2.

Support plate 2 x type Q for mounting support

VA

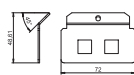
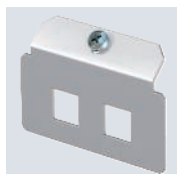

Type
MTM 2Q

Pack Piece	Weight kg/100 pc.	Item no.
1	3.800	7407818

Support plate to accept two fibre optic cable connection sockets, type Systemax.
Dimensions of a mounting opening in mm: 13.15 x 13.10.

Support plate, blank, for mounting support

St FS

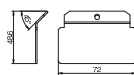
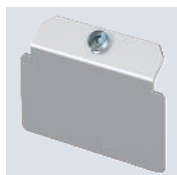

Type
MTM 0

Pack Piece	Weight kg/100 pc.	Item no.
1	6.330	7407764

"Blank" support plate for construction-side manufacture of a mounting opening for installation of connection sockets for data, audio or video systems.

Covers

Blanking cover for mounting support

St FS

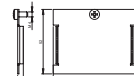
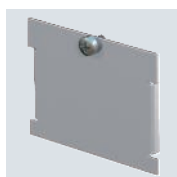

Type
MTU B

Pack Piece	Weight kg/100 pc.	Item no.
1	2.900	7407047

Blanking cover to close off an unused mounting slot for a support plate.



VA

Mounting support – MT2 2ACO

Type	Pack Piece	Weight kg/100 pc.	Item no.
MT2 2ACO	1	13.400	7407688

Mounting support for installation of two or three data modules of type ACO (only with Insta Kit UF 60 from AMP Tyco). Use instead of a GB2 or GB3 mounting box.

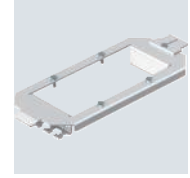
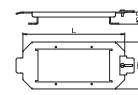

VA

Mounting support – MT3 3ACO

Type	Pack Piece	Weight kg/100 pc.	Item no.
MT3 3ACO	1	14.210	7407712

Mounting support for installation of two data modules of type ACO (only with Insta Kit UF 60 from AMP Tyco). Use instead of a GB2 mounting box.

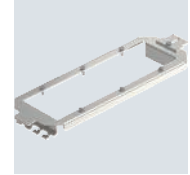
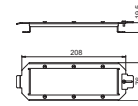

Flush-mount unit for data technology, type A

PC

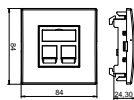

Type	Colour	Pack	Weight	Item no.
		Piece	kg/100 pc.	
DTE-RW G2A1	Pure white	4	5.000	6119494

Installation unit to accommodate two type A data technology modules, suitable for installation in Rapid 80 device installation trunking systems and ISS service poles. The type A data technology support is suitable for accepting the following data connection modules: AMP TYCO (without dust protection cap): SL Series 110Connect and SL Series Toolless; Brand-Rex: modules with item numbers ending in ...JAKS000CR and ...JAKU002; Nexans: LANmark RJ45 with blue adapter clip, LANmark GG45 with metal clip.

- Installation unit, consisting of:
- Mounting support, single, type 71MT1 45
 - Data technology support, straight outlet, type DTG-2A, colour: see table
 - Cover frame AR45, single, without labelling panel, colour: pure white

Flush-mount unit for data technology, type C

PC

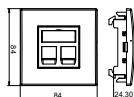

Type	Colour	Pack	Weight	Item no.
		Piece	kg/100 pc.	
DTE-RW G2C1	Pure white	4	5.000	6119492

Installation unit to accommodate two type C data technology modules, suitable for installation in Rapid 80 device installation trunking systems and ISS service poles. The type C data technology support is suitable for accepting the following data connection modules: BTR (Keystone design): Cat. 6A module and UAE module; Corning: modules with Keystone seat; CobiNet: CobiDat KS module; Dätwyler: KS-T, KS-TS, MS-K and KU-T; EKV: E-Stone; Harting: Prelink Keystone Cat. 6A; Fixlink Keystone Cat. 6A; Komos: KDM 500 module; Leoni Kerpen: MegaLine Keystone Cat. 6A; OBO: Type ASM-C6A and ASM-C6A G; R&M: Cat. 6A with Keystone fastening; Rutenbeck: UM and UMflex; SETEC: UKJ and XKJ; Telegärtner: AMJ and UMJ.

- Installation unit, consisting of:
- Mounting support, single, type 71MT1 45
 - Data technology support, straight outlet, type DTG-2C, colour: see table
 - Cover frame AR45, single, without labelling panel, colour: pure white

Flush-mount unit for data technology, type RM

PC

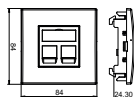

Type	Colour	Pack	Weight	Item no.
		Piece	kg/100 pc.	
DTE-RW G2RM1	Pure white	4	5.000	6119490

Installation unit to accommodate two type RM data technology modules, suitable for installation in Rapid 80 device installation trunking systems and ISS service poles. The type RM data technology support is suitable for accepting the following data connection modules: OBO (type): ASM-C5, ASM-C5 G, ASM-C6 and ASM-C6 G; R&M: Cat. 5 and Cat. 6 modules without support plate.

- Installation unit, consisting of:
- Mounting support, single, type 71MT1 45
 - Data technology support, straight outlet, type DTG-2RM, colour: see table
 - Cover frame AR45, single, without labelling panel, colour: pure white

Preterminated installation unit for decentral protection

PC

Installation unit AR45, for 2 PU

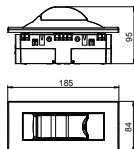

Type	Colour	Pack	Weight	Item no.
		Piece	kg/100 pc.	
IKR-6 RW	Pure white	1	19.000	6119319

Installation unit to accept protective units such as miniature circuit breakers or FI protection switches up to max. 2 PUs, suitable for installation in Rapid 80 device installation trunking systems and ISS service poles.

- Installation unit, consisting of:
- Accessory mounting box, triple, type 71GD9-2
 - Cover, incl. PVC support clamp for 2 PUs, colour: see table
 - Cover frame AR45, triple, without labelling panel, colour: pure white

AR45 installation unit, for 3 PUs

Type	Installation depth mm	Pack Piece	Weight kg/100 pc.	Item no.
IKR4RW	52	1	85.400	6288365

Installation unit for the installation of automatic circuit breakers or FI protection switches in device installation trunking. With 1 hat rail of 3 part units. Series terminals for N and PE on hat rails, completely wired with 6 mm². The flush-mount unit is pre-wired and ready for connection. The cable cross-section is 6 mm². Two type V-Tec M20 cable glands for cable entry are included in the delivery.

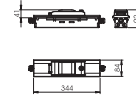

St P

Installation unit for series-mounted devices, 70 x 170 mm

Type	Pack Piece	Weight kg/100 pc.	Item no.
IKR12RW70170	1	450.000	6288328

Installation unit made of sheet steel for installation in the trunking section of device installation trunking of the corresponding system size. Acceptance of series-mounted devices with a total width of 12 PUs on hat rails. Incl. N and PE rails with screwless terminals. The foldable transparent hood can be locked.

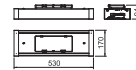

St P

Installation unit for series-mounted devices, 90 x 170 mm

Type	Pack Piece	Weight kg/100 pc.	Item no.
IKR12RW90170	1	470.000	6288330

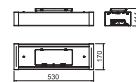

St P

Installation unit for series-mounted devices, 70 x 210 mm

Type	Pack Piece	Weight kg/100 pc.	Item no.
IKR12RW70210	1	480.000	6288334

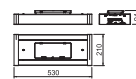

St P

Installation unit for series-mounted devices, 90 x 210 mm

Type	Pack Piece	Weight kg/100 pc.	Item no.
IKR12RW90210	1	500.000	6288336

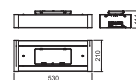

RJ45 data connection module, Cat. 5e, shielded

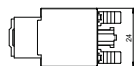
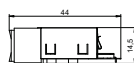

Type
ASM-C5 G

Pack Piece	Weight kg/100 pc.	Item no.
1	2.660	6117325

Connection module Cat. 5e shielded, with an RJ 45 slot. Includes an EMC screen hood, a dust cover, a cable tie and mounting instructions. Suitable for installation in data technology supports of type DTG-2RM and DTS-2RM.

RJ45 data connection module, Cat. 5e, unshielded

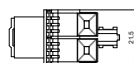
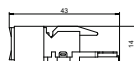

Type
ASM-C5

Pack Piece	Weight kg/100 pc.	Item no.
1	1.120	6117337

Connection module Cat. 5e unshielded, with an RJ 45 slot. Including a dust cover, a cable tie and mounting instructions. Suitable for installation in data technology supports of type DTG-2RM and DTS-2RM.

Connection module Cat. 5, shielded, snap-in

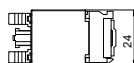
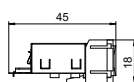

Type
ASM-C5 GS

Pack Piece	Weight kg/100 pc.	Item no.
1	1.920	6117343

Connection module Cat. 5e shielded, with an RJ45 slot. Including an EMC screen hood, a dust cover, a cable tie, a snap-in fastening frame and mounting instructions. Suitable for installation in support plates, type MTM 2C and MTM 3C, mounting plate type MPR2 2C, mounting support type MTGE2 2C, MTGE2 15 2C and MTGE2 F 2C.

Connection module Cat. 5, unshielded, snap-in

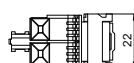
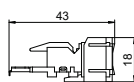

Type
ASM-C5 S

Pack Piece	Weight kg/100 pc.	Item no.
1	1.120	6117347

Connection module Cat. 5e unshielded, with a RJ45 slot. Including a dust cover, a cable tie, a snap-in fastening frame and mounting instructions. Suitable for installation in support plates, type MTM 2C and MTM 3C, mounting plate type MPR2 2C, mounting support type MTGE2 2C, MTGE2 15 2C and MTGE2 F 2C.

RJ45 data connection module, Cat. 6, shielded

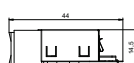

Type
ASM-C6 G

Pack Piece	Weight kg/100 pc.	Item no.
1	1.850	6117329

Connection module Cat. 6 shielded, with an RJ 45 slot. Includes an EMC screen hood, a dust cover, a cable tie and mounting instructions. Suitable for installation in data technology supports of type DTG-2RM and DTS-2RM.

RJ45 data connection module, Cat. 6, unshielded

Type	Pack Piece	Weight kg/100 pc.	Item no.
ASM-C6	1	1.060	6117341

Connection module Cat. 6 unshielded, with an RJ 45 slot. Including a dust cover, a cable tie and mounting instructions. Suitable for installation in data technology supports of type DTG-2RM and DTS-2RM.

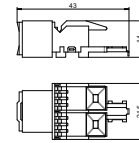

Connection module Cat. 6A, shielded, snap-in

Type	Pack Piece	Weight kg/100 pc.	Item no.
ASM-C6A G	1	1.630	6117346

Connection module Cat. 6A (ISO) shielded, with an RJ45 slot. Including an EMC screen hood, a dust cover, a cable tie, a Keystone fastening frame and mounting instructions. Suitable for installation in the data technology supports of type DTG-2C and DTS-2C, support plate of type MTM 2C and MTM 3C, mounting plate of type MPR2 2C, mounting supports of type MTGE2 2C, MTGE2 15 2C and MTGE2 F 2C.

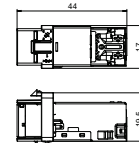

Connection module Cat. 6A, unshielded, snap-in

Type	Pack Piece	Weight kg/100 pc.	Item no.
ASM-C6A	1	1.050	6117348

Connection module Cat. 6A (ISO) unshielded, with an RJ45 slot. Including a dust cover, a cable tie, a Keystone fastening frame and mounting instructions. Suitable for installation in the data technology supports of type DTG-2C and DTS-2C, support plate of type MTM 2C and MTM 3C, mounting plate of type MPR2 2C, mounting supports of type MTGE2 2C, MTGE2 15 2C and MTGE2 F 2C.

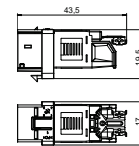

Connection module Cat. 6, shielded, snap-in

Type	Pack Piece	Weight kg/100 pc.	Item no.
ASM-C6 GS	1	1.850	6117345

Connection module Cat. 6 shielded, with an RJ45 slot. Including an EMC screen hood, a dust cover, a cable tie, a snap-in fastening frame and mounting instructions. Suitable for installation in support plates, type MTM 2C and MTM 3C, mounting plate type MPR2 2C, mounting support type MTGE2 2C, MTGE2 15 2C and MTGE2 F 2C.

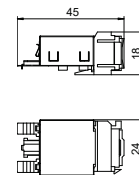

Connection module Cat. 6, unshielded, snap-in

Type	Pack Piece	Weight kg/100 pc.	Item no.
ASM-C6 S	1	1.060	6117349

Connection module Cat. 6 unshielded, with an RJ45 slot. Including a dust cover, a cable tie, a snap-in fastening frame and mounting instructions. Suitable for installation in support plates, type MTM 2C and MTM 3C, mounting plate type MPR2 2C, mounting support type MTGE2 2C, MTGE2 15 2C and MTGE2 F 2C.

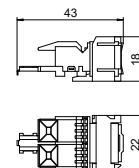

VGA connection, 1 module, straight outlet, as screw connection

Type	MTG-VGA S RW1	MTG-VGA S SWGR1	MTG-VGA S AL1
Colour	Pure white	Black-grey	Aluminium-painted
Pack Piece	1	1	1
Weight kg/100 pc.	2.400	2.400	2.400
Item no.	6104610	6104613	6104616

PC Polycarbonate

Multimedia support with one VGA connection socket, straight cable outlet, with labelling panel, VGA socket (HD15) with screw connection. Support plate with locking fastening, suitable for horizontal and vertical installation in the system environment.

VGA connection, 1 module, slanting outlet, as screw connection

Type	MTS-VGA S RW1	MTS-VGA S SWGR1	MTS-VGA S AL1
Colour	Pure white	Black-grey	Aluminium-painted
Pack Piece	1	1	1
Weight kg/100 pc.	2.600	2.600	2.600
Item no.	6104622	6104625	6104628

PC Polycarbonate

Multimedia support with one VGA connection socket, slanting cable outlet, with labelling panel, VGA socket (HD15) with screw connection. Support plate with locking fastening, suitable for horizontal and vertical installation in the system environment.

VGA connection, 1 module, straight outlet, with connection cable

Type	MTG-VGA F RW1	MTG-VGA F SWGR1	MTG-VGA F AL1
Colour	Pure white	Black-grey	Aluminium-painted
Pack Piece	1	1	1
Weight kg/100 pc.	5.200	5.200	5.200
Item no.	6104658	6104661	6104664

PC Polycarbonate

Multimedia support with one VGA connection socket, straight cable outlet, with labelling panel, short VGA connection cable (HD15), socket-socket version. Support with locking fastening, suitable for horizontal and vertical installation in the system environment.



VGA connection, 1 module, slanting outlet, with connection cable



Type	MTS-VGA F RW1	MTS-VGA F SWGR1	MTS-VGA F AL1
Colour	Pure white	Black-grey	Aluminium-painted
Pack Piece	1	1	1
Weight kg/100 pc.	6.063	5.400	5.400
Item no.	6104670	6104673	6104676

PC Polycarbonate

Multimedia support with one VGA connection socket, slanting cable outlet, with labelling panel, short VGA connection cable (HD15), socket-socket version. Support with locking fastening, suitable for horizontal and vertical installation in the system environment.

Mini jack connection, 1 module, straight outlet, as soldered connection



Type	MTG-MK L RW1	MTG-MK L SWGR1	MTG-MK L AL1
Colour	Pure white	Black-grey	Aluminium-painted
Pack Piece	1	1	1
Weight kg/100 pc.	1.500	1.500	2.128
Item no.	6104946	6104949	6104952

PC Polycarbonate

Multimedia support with one mini jack connection socket, straight cable outlet, with labelling panel, mini cinch socket (TRS 3.5 mm) with soldered connection. Support plate with locking fastening, suitable for horizontal and vertical installation in the system environment.

Mini jack connection, 1 module, slanting outlet, as soldered connection



Type	MTS-MK L RW1	MTS-MK L SWGR1	MTS-MK L AL1
Colour	Pure white	Black-grey	Aluminium-painted
Pack Piece	1	1	1
Weight kg/100 pc.	1.700	1.700	1.700
Item no.	6104958	6104961	6104964

PC Polycarbonate

Multimedia support with one mini jack connection socket, slanting cable outlet, with labelling panel, mini cinch socket (TRS 3.5 mm) with soldered connection. Support plate with locking fastening, suitable for horizontal and vertical installation in the system environment.





Video cinch connection, 1 module, straight outlet, as 1:1 coupling

			
Type	MTG-R F RW1	MTG-R F SWGR1	MTG-R F AL1
Colour	Pure white	Black-grey	Aluminium-painted
Pack Piece	1	1	1
Weight kg/100 pc.	1.500	1.500	1.500
Item no.	6104994	6104997	6105000

PC Polycarbonate

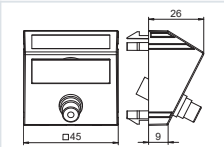
Multimedia support with one cinch connection socket for composite video, straight cable outlet, with labelling panel, cinch coupling (RCA), socket-socket version, colour coding yellow. Support plate with locking fastening, suitable for horizontal and vertical installation in the system environment.

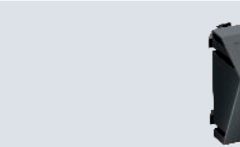



Video cinch connection, 1 module, slanting outlet, as 1:1 coupling

			
Type	MTS-R F RW1	MTS-R F SWGR1	MTS-R F AL1
Colour	Pure white	Black-grey	Aluminium-painted
Pack Piece	1	1	1
Weight kg/100 pc.	1.700	1.700	1.700
Item no.	6105006	6105009	6105012

PC Polycarbonate

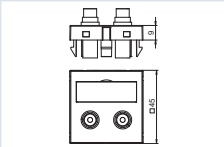
Multimedia support with one cinch connection socket for composite video, slanting cable outlet, with labelling panel, cinch coupling (RCA), socket-socket version, colour coding yellow. Support plate with locking fastening, suitable for horizontal and vertical installation in the system environment.

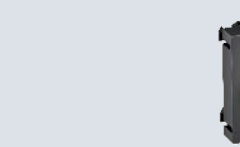
Audio cinch connection, 1 module, straight outlet, as 1:1 coupling

			
Type	MTG-2R F RW1	MTG-2R F SWGR1	MTG-2R F AL1
Colour	Pure white	Black-grey	Aluminium-painted
Pack Piece	1	1	1
Weight kg/100 pc.	2.500	2.500	2.500
Item no.	6105066	6105069	6105072

PC Polycarbonate

Multimedia support with two cinch connection sockets for audio R/L, straight cable outlet, with labelling panel, two cinch couplings (RCA), socket-socket version, colour coding red/white. Support plate with locking fastening, suitable for horizontal and vertical installation in the system environment.

Audio cinch connection, 1 module, slanting outlet, as 1:1 coupling

Type	MTS-2R F RW1	MTS-2R F SWGR1	MTS-2R F AL1
Colour	Pure white	Black-grey	Aluminium-painted
Pack Piece	1	1	1
Weight kg/100 pc.	2.700	2.700	2.700
Item no.	6105078	6105081	6105084

PC Polycarbonate

Multimedia support with two cinch connection sockets for audio R/L, slanting cable outlet, with labelling panel, two cinch couplings (RCA), socket-socket version, colour coding red/white. Support plate with locking fastening, suitable for horizontal and vertical installation in the system environment.

Component video connection, 1 module, straight outlet, as 1:1 coupling

Type	MTG-3R F RW1	MTG-3R F SWGR1	MTG-3R F AL1
Colour	Pure white	Black-grey	Aluminium-painted
Pack Piece	1	1	1
Weight kg/100 pc.	3.200	3.200	3.200
Item no.	6105138	6105141	6105144

PC Polycarbonate

Multimedia support with three cinch connection sockets for component video, straight cable outlet, with labelling panel, three cinch couplings (RCA), socket-socket version, colour coding red/green/blue. Support plate with locking fastening, suitable for horizontal and vertical installation in the system environment.





Component video connection, 1 module, slanting outlet, as 1:1 coupling

Type	MTS-3R F RW1	MTS-3R F SWGR1	MTS-3R F AL1
Colour	Pure white	Black-grey	Aluminium-painted
Pack Piece	1	1	1
Weight kg/100 pc.	3.400	3.400	3.400
Item no.	6105150	6105153	6105156

PC Polycarbonate

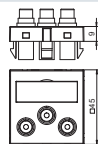
Multimedia support with three cinch connection sockets for component video, slanting cable outlet, with labelling panel, three cinch couplings (RCA), socket-socket version, colour coding red/green/blue. Support plate with locking fastening, suitable for horizontal and vertical installation in the system environment.

Audio/video cinch connection, 1 module, straight outlet, as 1:1 coupling

			
Type	MTG-12R F RW1	MTG-12R F SWGR1	MTG-12R F AL1
Colour	Pure white	Black-grey	Aluminium-painted
Pack Piece	1	1	1
Weight kg/100 pc.	3.200	3.200	3.200
Item no.	6105186	6105189	6105192

PC Polycarbonate

Multimedia support with three cinch connection sockets for audio/video, straight cable outlet, with labelling panel, three cinch couplings (RCA), socket-socket version, colour coding yellow/red/white. Support plate with locking fastening, suitable for horizontal and vertical installation in the system environment.





Audio/video cinch connection, 1 module, slanting outlet, as 1:1 coupling

			
Type	MTS-12R F RW1	MTS-12R F SWGR1	MTS-12R F AL1
Colour	Pure white	Black-grey	Aluminium-painted
Pack Piece	1	1	1
Weight kg/100 pc.	3.400	3.400	3.400
Item no.	6105198	6105201	6105204

PC Polycarbonate

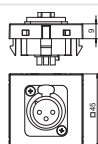
Multimedia support with three cinch connection sockets for audio/video, slanting cable outlet, with labelling panel, three cinch couplings (RCA), socket-socket version, colour coding yellow/red/white. Support plate with locking fastening, suitable for horizontal and vertical installation in the system environment.





XLR connection, 1 module, straight outlet, 3-pin socket, as soldered connection

			
Type	MTG-X3F L RW1	MTG-X3F L SWGR1	MTG-X3F L AL1
Colour	Pure white	Black-grey	Aluminium-painted
Pack Piece	1	1	1
Weight kg/100 pc.	3.000	3.000	3.000
Item no.	6105210	6105213	6105216

PC Polycarbonate

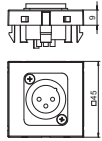
Multimedia support with one XLR connection socket, straight cable outlet, without labelling panel, 3-pin XLR socket with soldered connection. Support plate with locking fastening, suitable for horizontal and vertical installation in the system environment.





XLR connection, 1 module, straight outlet, 3-pin connector, as soldered connection

			
Colour	Pure white	Black-grey	Aluminium-painted
Pack Piece	1	1	1
Weight kg/100 pc.	3.000	3.000	3.000
Item no.	6105222	6105225	6105228

PC Polycarbonate

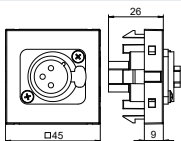
Multimedia support with one XLR connection socket, straight cable outlet, without labelling panel, 3-pin XLR connector with soldered connection. Support plate with locking fastening, suitable for horizontal and vertical installation in the system environment.





XLR connection, 1 module, straight outlet, 3-pin socket, as screw connection

			
Colour	Pure white	Black-grey	Aluminium-painted
Pack Piece	1	1	1
Weight kg/100 pc.	3.500	3.500	3.500
Item no.	6105250	6105252	6105254

PC Polycarbonate

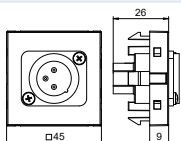
Multimedia support with one XLR connection socket, straight cable outlet, without labelling panel, 3-pin XLR socket with screw connection. Support plate with locking fastening, suitable for horizontal and vertical installation in the system environment.

XLR connection, 1 module, straight outlet, 3-pin connector, as screw connection

			
Colour	Pure white	Black-grey	Aluminium-painted
Pack Piece	1	1	1
Weight kg/100 pc.	3.500	3.500	3.500
Item no.	6105258	6105260	6105262

PC Polycarbonate

Multimedia support with one XLR connection socket, straight cable outlet, without labelling panel, 3-pin XLR socket with screw connection. Support plate with locking fastening, suitable for horizontal and vertical installation in the system environment.



Speakon connection, 1 module, straight outlet, 4-pin socket, as screw connection



Type	MTG-SON S RW1	MTG-SON S SWGR1	MTG-SON S AL1
Colour	Pure white	Black-grey	Aluminium-painted
Pack Piece	1	1	1
Weight kg/100 pc.	2.800	2.800	2.800
Item no.	6105270	6105272	6105274

PC Polycarbonate

Multimedia support with one Speakon connection socket, straight cable outlet, without labelling panel, Speakon 4-pin socket with screw connection. Support plate with locking fastening, suitable for horizontal and vertical installation in the system environment.

BNC connection, 1 module, straight outlet, as 1:1 coupling



Type	MTG-BC F RW1	MTG-BC F SWGR1	MTG-BC F AL1
Colour	Pure white	Black-grey	Aluminium-painted
Pack Piece	1	1	1
Weight kg/100 pc.	1.500	1.500	1.500
Item no.	6105018	6105021	6105024

PC Polycarbonate

Multimedia support with one BNC connection socket, straight cable outlet, with labelling panel, BNC coupling, socket-socket version. Support plate with locking fastening, suitable for horizontal and vertical installation in the system environment.

BNC connection, 1 module, slanting outlet, as 1:1 coupling





Type	MTS-BC F RW1	MTS-BC F SWGR1	MTS-BC F AL1
Colour	Pure white	Black-grey	Aluminium-painted
Pack Piece	1	1	1
Weight kg/100 pc.	1.700	1.700	1.700
Item no.	6105030	6105033	6105036

PC Polycarbonate

Multimedia support with one BNC connection socket, slanting cable outlet, with labelling panel, BNC cinch coupling, socket-socket version. Support plate with locking fastening, suitable for horizontal and vertical installation in the system environment.





2x BNC connection, 1 module, straight outlet, as 1:1 coupling

			
Type	MTG-2BC F RW1	MTG-2BC F SWGR1	MTG-2BC F AL1
Colour	Pure white	Black-grey	Aluminium-painted
Pack Piece	1	1	1
Weight kg/100 pc.	2.500	2.500	2.500
Item no.	6105090	6105093	6105096

PC Polycarbonate

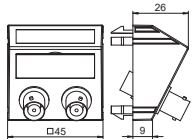
Multimedia support with two BNC connection sockets, straight cable outlet, with labelling panel, two BNC couplings, socket-socket version. Support plate with locking fastening, suitable for horizontal and vertical installation in the system environment.





2x BNC connection, 1 module, slanting outlet, as 1:1 coupling

			
Type	MTS-2BC F RW1	MTS-2BC F SWGR1	MTS-2BC F AL1
Colour	Pure white	Black-grey	Aluminium-painted
Pack Piece	1	1	1
Weight kg/100 pc.	2.700	2.700	2.700
Item no.	6105102	6105105	6105108

PC Polycarbonate

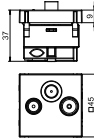
Multimedia support with two BNC connection sockets, slanting cable outlet, with labelling panel, two BNC couplings, socket-socket version. Support plate with locking fastening, suitable for horizontal and vertical installation in the system environment.

Antenna connection, 1 module, TV/radio/SAT, antenna socket





			
Type	ANT-3SD RW1	ANT-3SD SWGR1	ANT-3SD AL1
Colour	Pure white	Black-grey	Aluminium-painted
Pack Piece	1	1	1
Weight kg/100 pc.	11.596	11.596	11.000
Item no.	6105282	6105284	6105286

PC Polycarbonate

Socket for antenna, BK and satellite reception systems with connection for TV and radio.

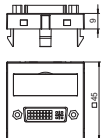
Frequency: 5–2150 MHz
 Heat attenuation: 5-862 MHz - 1dB
 950-2150 MHz - 2 dB
 Return channel attenuation: 14 dB
 EMC protection class A

DVI-D connection, 1 module, straight outlet, as screw connection





			
Type	MTG-DVI S RW1	MTG-DVI S SWGR1	MTG-DVI S AL1
Colour	Pure white	Black-grey	Aluminium-painted
Pack Piece	1	1	1
Weight kg/100 pc.	3.500	3.500	3.500
Item no.	6104730	6104733	6104736

PC Polycarbonate

Multimedia support with one DVI-D connection socket, straight cable outlet, with labelling panel, DVI-D socket with screw connection. Support plate with locking fastening, suitable for horizontal and vertical installation in the system environment.

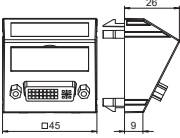
Note: Due to the device dimensions, device installation in Rapid 45 device installation trunking is not possible.





DVI-D connection, 1 module, slanting outlet, as screw connection

			
Type	MTS-DVI S RW1	MTS-DVI S SWGR1	MTS-DVI S AL1
Colour	Pure white	Black-grey	Aluminium-painted
Pack Piece	1	1	1
Weight kg/100 pc.	3.700	3.700	3.700
Item no.	6104742	6104745	6104748

PC Polycarbonate

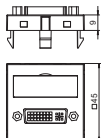
Multimedia support with one DVI-D connection socket, slanting cable outlet, with labelling panel, DVI-D socket with screw connection. Support plate with locking fastening, suitable for horizontal and vertical installation in the system environment.

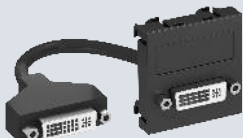

DVI-I connection, 1 module, straight outlet, with connection cable

			
Type	MTG-DVI F RW1	MTG-DVI F SWGR1	MTG-DVI F AL1
Colour	Pure white	Black-grey	Aluminium-painted
Pack Piece	1	1	1
Weight kg/100 pc.	6.000	6.000	6.000
Item no.	6104754	6104757	6104760

PC Polycarbonate

Multimedia support with one DVI-I connection socket, straight cable outlet, with labelling panel, short DVI-I connection cable, socket-socket version. Support with locking fastening, suitable for horizontal and vertical installation in the system environment.

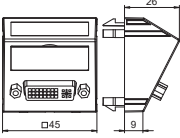

DVI-I connection, 1 module, slanting outlet, with connection cable

			
	Type	MTS-DVI F RW1	MTS-DVI F SWGR1
Colour	Pure white	Black-grey	Aluminium-painted
Pack Piece	1	1	1
Weight kg/100 pc.	6.200	6.200	6.200
Item no.	6104766	6104769	6104772

PC Polycarbonate

Multimedia support with one DVI-I connection socket, slanting cable outlet, with labelling panel, short DVI-I connection cable, socket-socket version. Support with locking fastening, suitable for horizontal and vertical installation in the system environment.

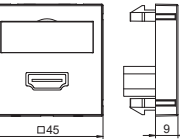
HDMI connection, 1 module, straight outlet, as screw connection



			
	Type	MTG-HD S RW1	MTG-HD S SWGR1
Colour	Pure white	Black-grey	Aluminium-painted
Pack Piece	1	1	1
Weight kg/100 pc.	3.200	3.200	3.200
Item no.	6104802	6104805	6104808

PC Polycarbonate

Multimedia support with one HDMI connection socket, straight cable outlet, with labelling panel, HDMI socket with screw connection. Support plate with locking fastening, suitable for horizontal and vertical installation in the system environment.

Note: Due to the device dimensions, device installation in Rapid 45 device installation trunking and ISSR..45 / ISSD..45 service poles is not possible.

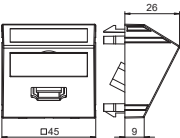
HDMI connection, 1 module, slanting outlet, as screw connection

			
	Type	MTS-HD S RW1	MTS-HD S SWGR1
Colour	Pure white	Black-grey	Aluminium-painted
Pack Piece	1	1	1
Weight kg/100 pc.	3.400	3.400	3.400
Item no.	6104814	6104817	6104820

PC Polycarbonate

Multimedia support with one HDMI connection socket, slanting cable outlet, with labelling panel, HDMI socket with screw connection. Support plate with locking fastening, suitable for horizontal and vertical installation in the system environment.

HDMI connection, 1 module, straight outlet, with connection cable

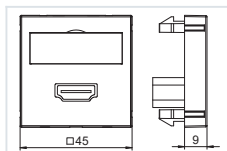

Type	MTG-HD F RW1	MTG-HD F SWGR1	MTG-HD F AL1
Colour	Pure white	Black-grey	Aluminium-painted
Pack Piece	1	1	1
Weight kg/100 pc.	6.000	6.000	6.000
Item no.	6104826	6104829	6104832

PC Polycarbonate

Multimedia support with one HDMI connection socket, straight cable outlet, with labelling panel, short HDMI connection cable, socket-socket version. Support plate with locking fastening, suitable for horizontal and vertical installation in the system environment.

HDMI connection, 1 module, slanting outlet, with connection cable

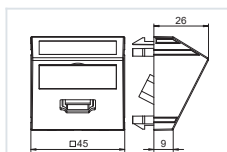

Type	MTS-HD F RW1	MTS-HD F SWGR1	MTS-HD F AL1
Colour	Pure white	Black-grey	Aluminium-painted
Pack Piece	1	1	1
Weight kg/100 pc.	6.200	6.200	6.200
Item no.	6104838	6104841	6104844

PC Polycarbonate

Multimedia support with one HDMI connection socket, slanting cable outlet, with labelling panel, short HDMI connection cable, socket-socket version. Support plate with locking fastening, suitable for horizontal and vertical installation in the system environment.

Multimedia support

Multimedia support for VGA/D-Sub9 plug connection, 1 module, straight outlet

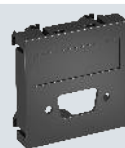
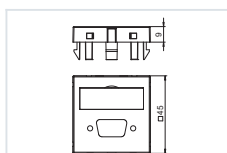



Type	MTG-DB O RW1	MTG-DB O SWGR1	MTG-DB O AL1
Colour	Pure white	Black-grey	Aluminium-painted
Pack Piece	1	1	1
Weight kg/100 pc.	0.700	0.700	0.700
Item no.	6104706	6104709	6104712

PC Polycarbonate

Multimedia support for a VGA / D-Sub9 plug connector, straight cable outlet, with labelling panel, without plug connector. Support plate with locking fastening, suitable for horizontal and vertical installation in the system environment.

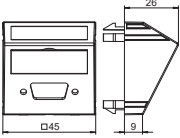

Multimedia support for VGA/D-Sub9 plug connector, 1 module, slanting outlet

			
	Type	MTS-DB O RW1	MTS-DB O SWGR1
Colour	Pure white	Black-grey	Aluminium-painted
Pack Piece	1	1	1
Weight kg/100 pc.	0.900	0.900	0.900
Item no.	6104718	6104721	6104724

PC Polycarbonate

Multimedia support for a VGA / D-Sub9 plug connector, slanting cable outlet, with labelling panel, without plug connector. Support plate with locking fastening, suitable for horizontal and vertical installation in the system environment.

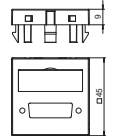

Multimedia support for DVI plug connector, 1 module, straight outlet

			
	Type	MTG-DV O RW1	MTG-DV O SWGR1
Colour	Pure white	Black-grey	Aluminium-painted
Pack Piece	1	1	1
Weight kg/100 pc.	0.700	0.700	0.700
Item no.	6104778	6104781	6104784

PC Polycarbonate

Multimedia support for a DVI plug connector, straight cable outlet, with labelling panel, without plug connector. Support plate with locking fastening, suitable for horizontal and vertical installation in the system environment.

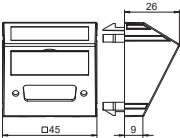
Multimedia support for DVI plug connector, 1 module, slanting outlet

			
	Type	MTS-DV O RW1	MTS-DV O SWGR1
Colour	Pure white	Black-grey	Aluminium-painted
Pack Piece	1	1	1
Weight kg/100 pc.	0.900	0.900	0.900
Item no.	6104790	6104793	6104796

PC Polycarbonate

Multimedia support for a DVI plug connector, slanting cable outlet, with labelling panel, without plug connector. Support plate with locking fastening, suitable for horizontal and vertical installation in the system environment.



Multimedia support for XLR plug connector, 1 module, straight outlet



Type	MTG-X O RW1	MTG-X O SWGR1	MTG-X O AL1
Colour	Pure white	Black-grey	Aluminium-painted
Pack Piece	1	1	1
Weight kg/100 pc.	0.600	0.600	0.600
Item no.	6105234	6105237	6105240

PC Polycarbonate

Multimedia support for an XLR plug connector, straight cable outlet, without labelling panel, without plug connector. Support plate with locking fastening, suitable for horizontal and vertical installation in the system environment.



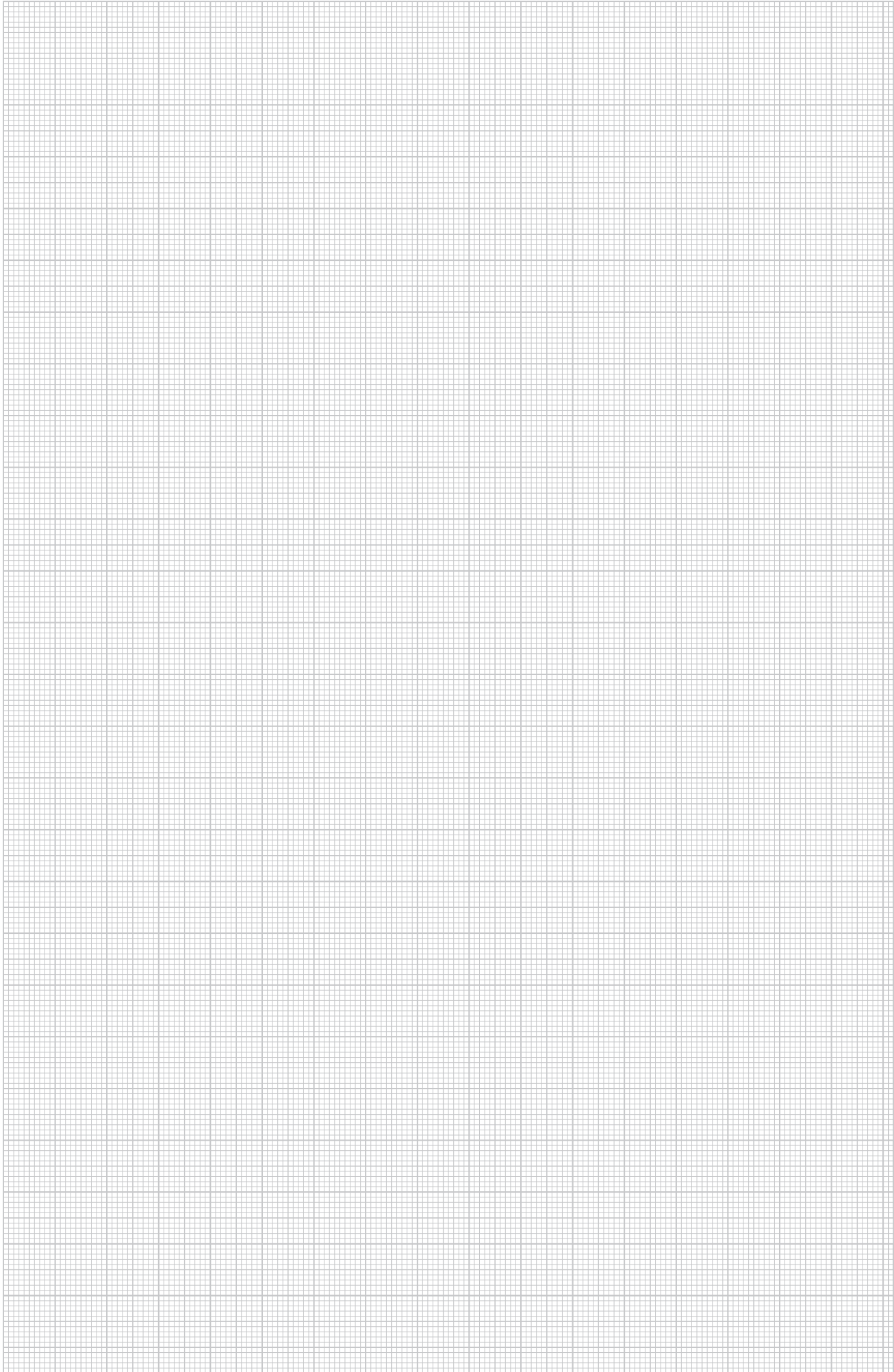

Tabletop sockets

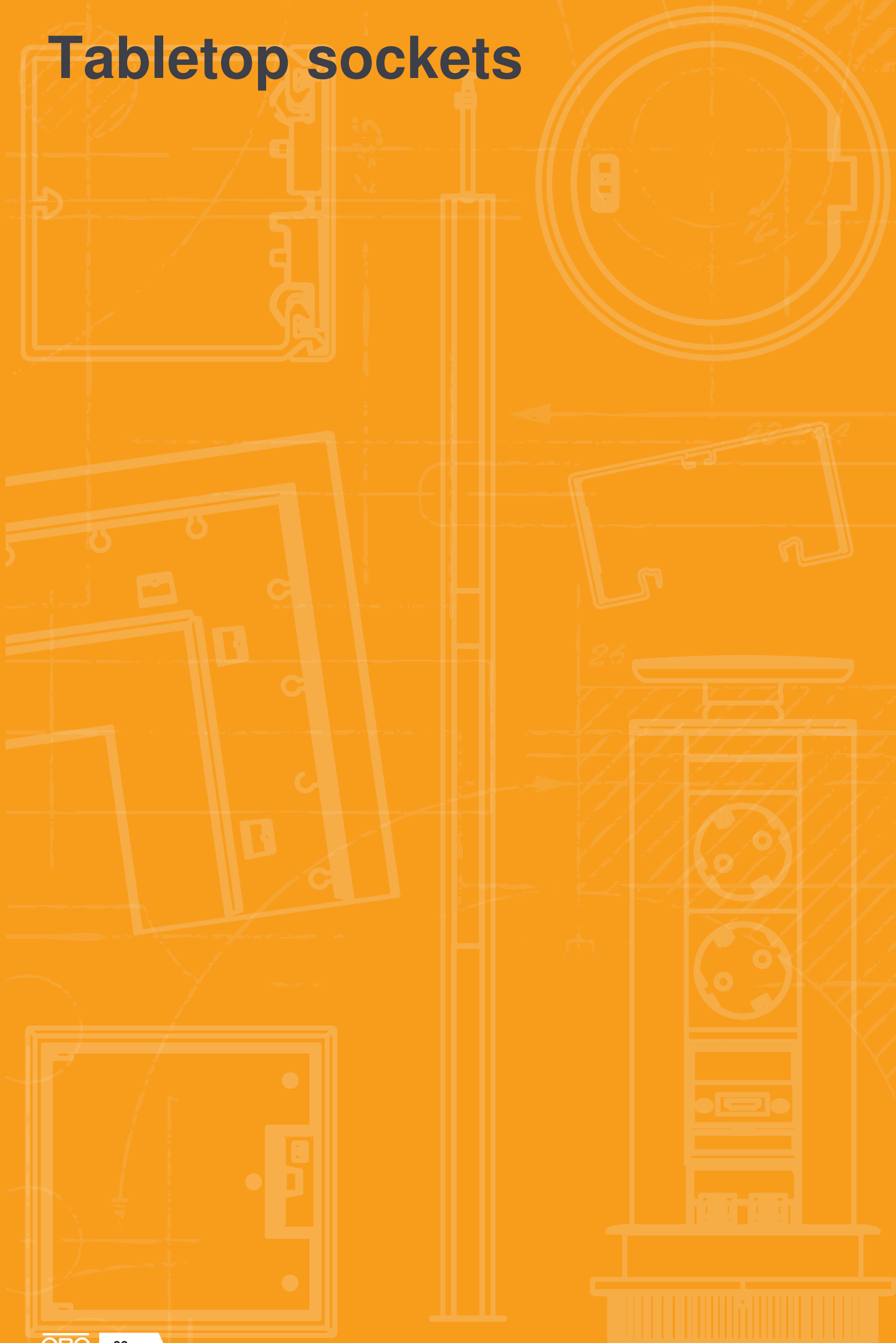

Tabletop sockets



Deskboxes

98



Accessories, Deskboxes

104



Flexkanal and accessories

106





Workplace solutions

Deskboxes and Flexkanal

Deskboxes by OBO offer direct access to power, data and multimedia connections for any workplace, such as in offices and meeting and conference rooms. Three different Deskbox solutions in high-quality material and elegant designs are available for individual requirements:

- Freely positionable Deskbox DB
- Lowerable Deskbox DBV
- Foldable Deskbox DBK



Freely locatable Deskbox DB



Lowerable Deskbox DBV



Foldable Deskbox DBK

Alu

Deskbox DB, freely placeable, 2+2 sockets, 2x RJ45 Cat. 6

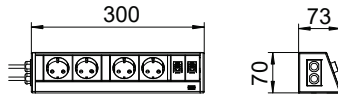

Deskbox with connection cable, cable outlet on the left and right using housing cover, freely placeable using non-slip support points.

Equipment:

- Two black protection contact sockets in 0° connection direction, incl. 3.0 m power cable with angular connector CEE 7/7, cable exit on the left housing cover.
- Two red protection contact sockets in 0° connection direction, incl. 3.0 m power cable with angular connector CEE 7/7, cable exit on the left housing cover.
- Two data technology couplings RJ45 to RJ45, 1:1 switched, Cat. 6 shielded, cable exit on the right housing cover.

Type	Version	Pack Piece	Weight kg/100 pc.	Item no.
DB-0A3 D22SR2K	Housing, silver anodised	1	100.000	6116918

Alu

Deskbox DB, without fastening material, 3 sockets



Deskbox with connection cable, cable outlet at the bottom of the profile, without fastening material, combinable with the fastening solutions listed in the accessories.

Equipment:

- Three black protection contact sockets in 0° connection direction, incl. 3.0 m power cable with angular connector CEE 7/7.

Type	Version	Pack Piece	Weight kg/100 pc.	Item no.
DB-0B3 D3S	Housing, silver anodised	1	66.000	6116939



DB – Ready-for-connection Deskbox, free positioning

Alu

Deskbox DB, without fastening material, 3 sockets

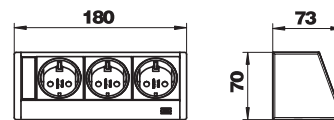

Type	Version	Pack Piece	Weight kg/100 pc.	Item no.
DB-0B3 D3S	Housing, silver anodised	1	66.000	6116939

Deskbox with connection cable, cable outlet at the bottom of the profile, without fastening material, combinable with the fastening solutions listed in the accessories.

Equipment:
 - Three black protection contact sockets in 0° connection direction, incl. 3.0 m power cable with angular connector CEE 7/7.

Deskbox DB, without fastening material, 3 sockets, 2x RJ45 Cat. 6

Alu



Type	Version	Pack Piece	Weight kg/100 pc.	Item no.
DB-0B3 D3S2K	Housing, silver anodised	1	85.700	6116945

Deskbox with connection cable, cable outlet at the bottom of the profile, without fastening material, combinable with the fastening solutions listed in the accessories.

Equipment:
 - Three black protection contact sockets in 0° connection direction, incl. 3.0 m power cable with angular connector CEE 7/7.
 - Two data technology couplings RJ45 to RJ45, 1:1 switched, Cat. 6 shielded.

DB – Ready-for-connection Deskbox, free positioning

Alu

Deskbox DB, with fastening clamp, 3 sockets, 2x RJ45 Cat. 6

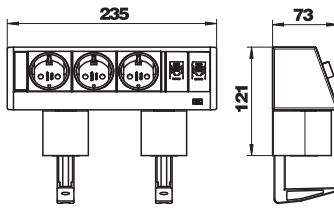

Deskbox with connection cable, cable outlet at the bottom of the profile with two fastening clamps for tabletop thicknesses of 8 to 40 mm.

Equipment:

- Three black protection contact sockets in 0° connection direction, incl. 3.0 m power cable with angular connector CEE 7/7.
- Two data technology couplings RJ45 to RJ45, 1:1 switched, Cat. 6 shielded.

Type	Version	Pack Piece	Weight kg/100 pc.	Item no.
DB-1B3 D3S2K	Housing, silver anodised	1	122.000	6116942

DBV - Ready-for-connection Deskbox, lowerable

Alu EL

Deskbox DBV, 3 sockets

Type	Pack Piece	Weight kg/100 pc.	Item no.
DBV-A3A D3S	1	98.230	6116862
DBV-A3E D3S	1	106.230	6116866

Lowerable Deskbox with connection cable for fixed installation on a tabletop, plastic fastening sleeve, painted accordingly in cover shade. It is mounted using a drill hole (Ø102 mm) in the tabletop.

Equipment:

- Three black protection contact sockets in 60° connection direction, incl. 3.0 m power cable with angular connector CEE 7/7.

Note: Can be used in tabletops of up to 50 mm thickness.

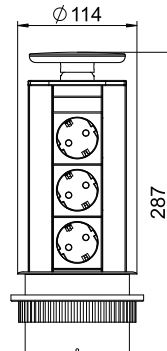

DBV - Ready-for-connection Deskbox, lowerable

Circular band saw for Deskbox DBV

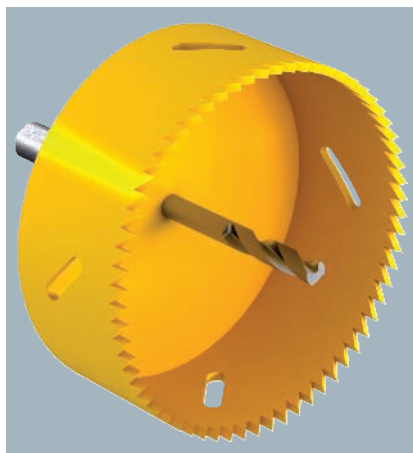

Type	Pack	Weight	Item no.
DBZ-LS	1	100.000	6116994

Circular band saw as a mounting tool for precise installation of a Deskbox of type DBV, drill hole diameter 102 mm.

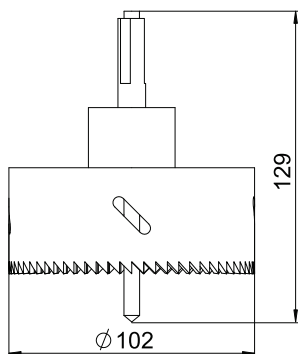

DBK - Ready-for-connection Deskbox, foldable

Deskbox DBK, 2 sockets, HDMI, 2x RJ45 Cat. 6

VA

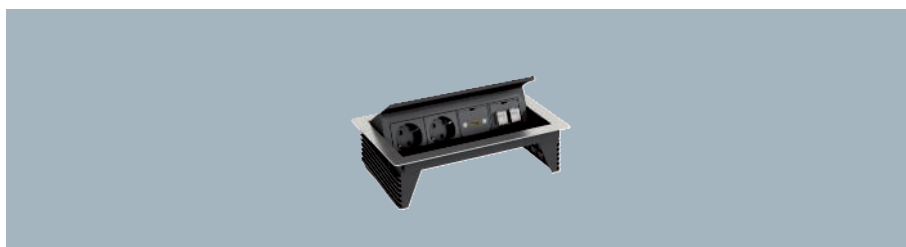

Type	Pack	Weight	Item no.
DBK2-M4H D2S2K	1	173.760	6116810

Foldable Deskbox with connection cable for fixed installation in a tabletop, housing made of brushed stainless steel with brush bar as cable outlet. Mounting is done via an installation opening 245 x 157 mm in the tabletop.

Equipped with:

- two black protective contact sockets of 60° plug-in direction, including 3.0 power cable with angular connector CEE 7/7.
- one HDMI 1.3 socket, including 3.0 connection cable with plug.
- two data technology couplings RJ45 on RJ45, 1:1, Cat. 6 shielded.

Note: Can be used in table tops of up to 50 mm thickness.



VA

Deskbox DBK, 3 sockets, 2x RJ45 Cat. 6

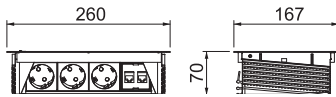

Foldable Deskbox with connection cable for fixed installation in a tabletop, housing made of brushed stainless steel with brush bar as cable outlet. Mounting is done via an installation opening 245 x 157 mm in the tabletop.

Equipped with:

- three black protective contact sockets of 60° plug-in direction, including 3.0 m power cable with angular connector CEE 7/7.
- two data technology couplings RJ45 on RJ45, 1:1, Cat. 6 shielded.

Note: Can be used in table tops of up to 50 mm thickness.

Type

DBK2-D4 D3S2K

Pack Piece	Weight kg/100 pc.	Item no.
1	163.860	6116806



Fastening clamps

Fastening clamp for Deskbox DB

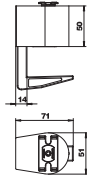

Type	Colour	Version	Pack Piece	Weight kg/100 pc.	Item no.
DBZ-BZ40	Black	Clamping range 8 to 40 mm	1	18.000	6116976
DBZ-BZ75	Black	Clamping range 40 to 75 mm	1	20.000	6116979

Fastening clamp for mounting a Deskbox type DB-... on the tabletop.

Note: For housing widths of 200 mm or more, two fastening clamps are required to mount a Deskbox.

Fastening stands

Stainless steel fastening stand for Deskbox DB

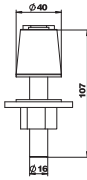

Type	Pack Piece	Weight kg/100 pc.	Item no.
DBZ-BFE	1	34.000	6116982

Stainless steel fastening stand for fixed mounting of a Deskbox type DB-... on a tabletop. It is mounted using a drill hole (Ø16 mm) in the tabletop.

Note: Can be used in tabletops of up to 50 mm thickness.

Fastening sets

Fastening set for table mounting, for DB Deskbox

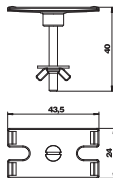

Type	Pack Piece	Weight kg/100 pc.	Item no.
DBZ-BST	1	2.300	6116985

Fastening set for fixed mounting of a Deskbox, type DB, under the tabletop. It is mounted using a drill hole (Ø10 mm) in the tabletop.

Note: The supplied fastening screws (M4 x 40 mm) can be used for tabletops of up to a maximum thickness of 32 mm.

Fastening set for under-table mounting, for DB Deskbox

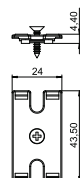
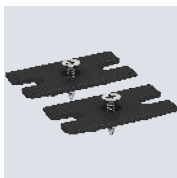

Type	Pack Piece	Weight kg/100 pc.	Item no.
DBZ-BSUT	1	100.000	6116986

Fastening set for fixed mounting of the Deskbox, type DB, under the tabletop. It is mounted on the tabletop using two wood screws.

Circular band saw for Deskbox DBV

Type	Pack Piece	Weight kg/100 pc.	Item no.
DBZ-LS	1	100.000	6116994

Circular band saw as a mounting tool for precise installation of a Deskbox of type DBV, drill hole diameter 102 mm.

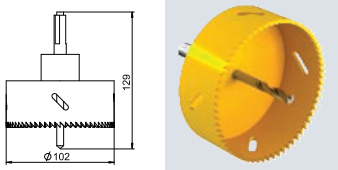

Flexkanal

Flexkanal



Type	Length mm	Colour	Pack m	Weight kg/100 m	Item no.
FLK-2K LGR	1000	Light grey	1	28.800	6154922
FLK-2K SWGR	1000	Black-grey	1	28.800	6154930

The Flexkanal runs your cables ordered and protected to the desk. It connects the Deskbox with the dado duct or with the floor connection box. When extended, the Flexkanal is 1,000 mm long, 60 mm wide and 20 mm high.

The duct consists of two chambers, capacity per chamber:
two cables of 8.5 mm diameter or three cables of 7.5 mm diameter or
four cables of 7.0 mm diameter or five cables of 6.0 mm diameter.

Strain reliefs

Holder with strain relief for Flexkanal

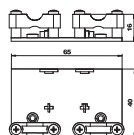

Type	Colour	Pack Piece	Weight kg/100 pc.	Item no.
FLK-HL ZL	Anthracite grey	1	10.500	6154961

The holder possesses two integrated strain reliefs and can be screwed on. A Flexkanal can be mounted directly on the holder.

Fastening bracket

Fastening clamp for Flexkanal

Alu

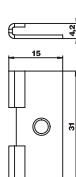
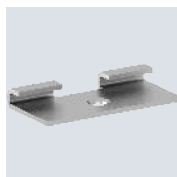

Type	Pack Piece	Weight kg/100 pc.	Item no.
FLK-BEF	10	0.150	6154968

The Flexkanal is suspended from the fastening clamp. The holder is fastened using a countersunk union.

Floor rails

Floor rail for Flexkanal

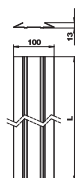

Type	Length mm	Colour	Pack Piece	Weight kg/100 pc.	Item no.
FLK-BS1	1000	Anthracite grey	1	19.400	6154980
FLK-BS2	2000	Anthracite grey	1	19.400	6154983

The Flexkanal is pushed directly into the floor rail. The ramp on both sides reduces the risk of stumbling.

T branch for Flexkanal

Type	Colour	Pack Piece	Weight kg/100 pc.	Item no.
FLK-TAZ	Anthracite grey	1	8.700	6154965

T branch for supply of working places with the Flexkanal.

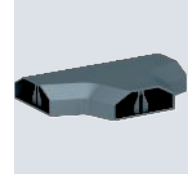
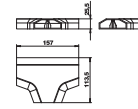

Holder

Flexkanal holder for Deskbox DB

Type	Colour	Pack Piece	Weight kg/100 pc.	Item no.
DBZ-FLKB	Black	1	1.100	6116991

Flexkanal holder for Deskbox, type DB, for secure connection of a Flexkanal to the Deskbox.

Note: Can only be used for mounting on the tabletop using fastening clamps.

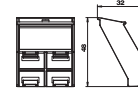



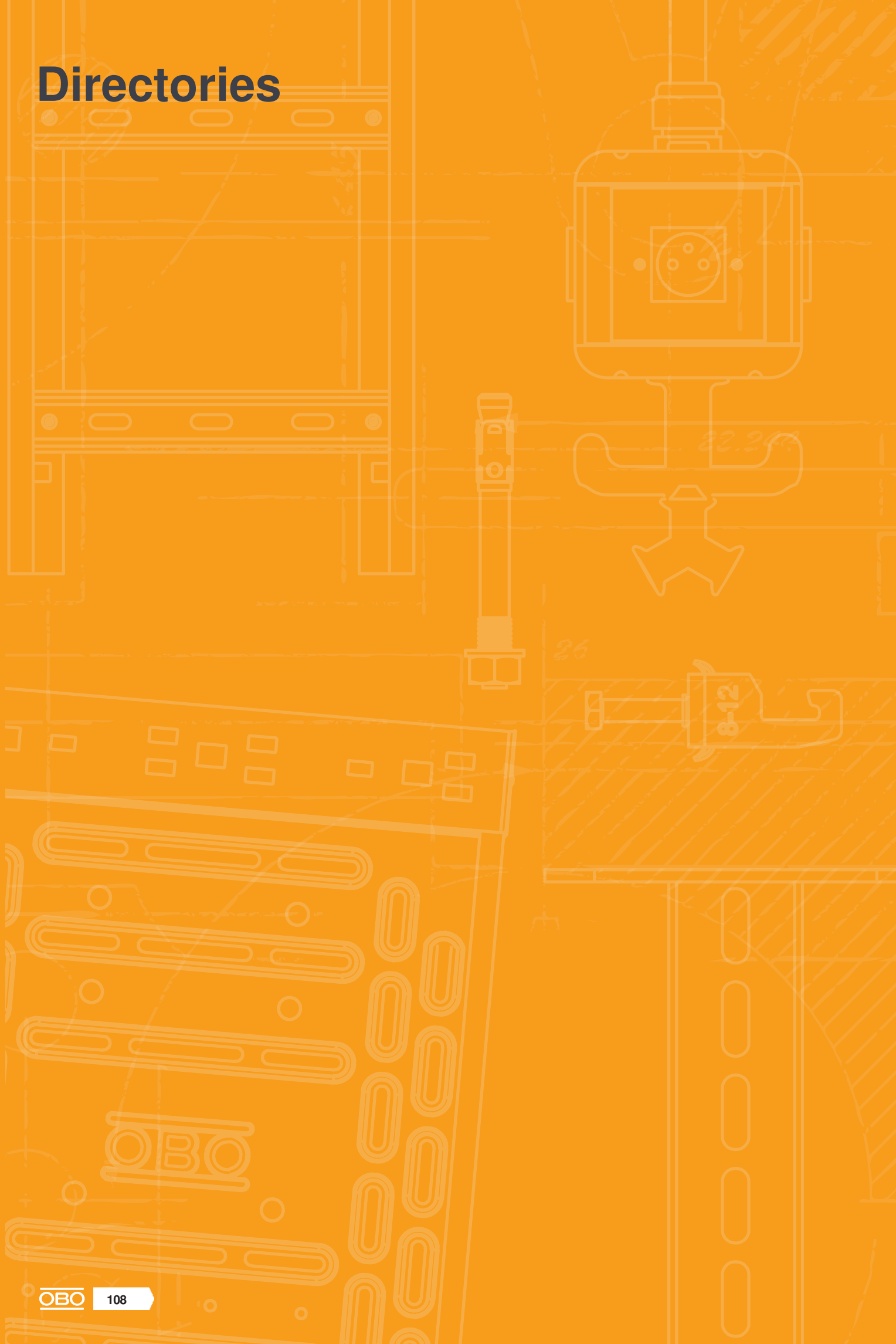

Directories







































Directories

	Test marks	110
	Pictogram explanation	112
	Numeric directory	116



Test marks

	American Bureau of Shipping, USA		Underwriters Laboratories Inc., USA + CSA, Canada
	AENOR, Producto Certificado, Spain		Österreichischer Verband für Elektrotechnik, Austria
	STOWARZYSZENIE ELEKTRYKÓW POLSKICH, Poland		ISTITUTO ITALIANO DEL MARCHO DI QUALITÀ, Italy
	Lightning current-tested		RINA 1861, Ship Classification, Certification and Services
	Lightning current-tested, Class H (100 kA)		Underwriters Laboratories Inc., USA
	CEBEC, Belgium		SEMKO An Inchcape Testing Services Company, Sweden
	Canadian Standards Association, Canada		Eidgenössisches Starkstrominspektorat, Switzerland
	DEMKO, Danmarks Elektriske Materielkontrol, Denmark		South African Bureau of Standards
	Deutsches Institut für Bautechnik Berlin, Germany		Shock-tested, Bundesamt für Zivilschutz, Germany
	Det Norske Veritas		Sähköarkastuskeskus Elinspektionscentralen Electrical Inspectorate, Finland
	ENEC Austria		Underwriters Laboratories Inc., USA
	ATEX certificate for explosive areas		Underwriters Laboratories Inc., USA
	ELEKTROTECHNICKÝ ZKUŠEBNÍ ÚSTAV, Czech Republic		Verband der Elektrotechnik, Elektronik, Informationstechnik e.V., Germany
	FIMKO, Finland		German Association of Electricians, tested safety
	Forschungs- und Materialprüfungsanstalt, Germany		5-year warranty
	Russia, GOST The State Committee for Standards		
	Test marks for technical resources, VDE Prüf- und Zertifizierungsinstitut Offenbach, Germany		
	Halogen-free; without chlorine, fluorine and bromine		
	INMETRO, Brazil		
	KEMA-KEUR, Netherlands		
	Indication of metric products		
	MAGYAR ELEKTROTECHNIKAI ELLENŐRZŐ INTÉZET Budapest, Hungary		
	NEMKO, Norway		
	AFNOR Quality symbol of the French standardisation institute		

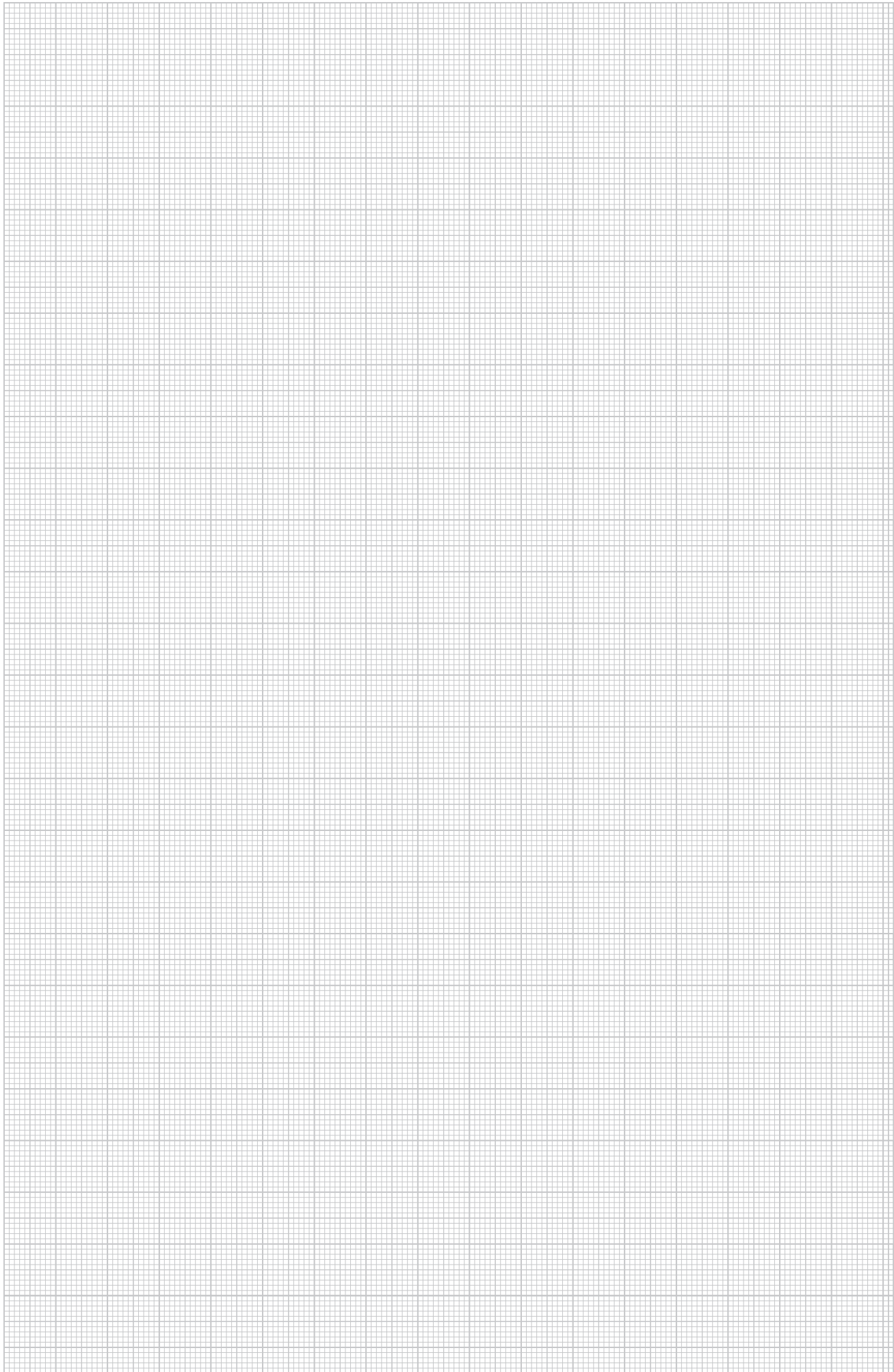

Pictogram explanation

Surfaces

FS	Strip galvanised
FSK	Strip galvanised/plastic-coated
DD	Strip galvanised zinc/aluminium, double dip
BK	Bright
EL	Anodised
F	Hot-dip galvanised
G	Electrogalvanised
EI	Electrogalvanised/plastic-coated
GCL	Electrogalvanised, yellow-chromated
GGP	Electrogalvanised, yellow passivated
GTP	Electrogalvanised, transparently passivated
GR	Primed
L	Painted
SG	Welding primed
FT	Hot-dip galvanised
FT SO	Hot-dip galvanised 85 µm
Cu	Copper-plated
N	Nickel-plated
ZD	Galvanised, Deltatone 500
ZDM	Galvanised, MAGNI 565
GA	Zinc-aluminium coated, Galfan
ZL	Zinc scale

Conformity symbol

CE	Communautés Européennes, EC declaration of conformity according to EC directives
RoHS conform	RoHS-conformant

Quality marks

Halogen-free	Halogen-free; without chlorine, fluorine and bromine
650	Flame resistant 650 °C
750	Flame resistant 750 °C
960	Flame resistant 960 °C
UV resistant	UV-resistant

Specific product symbols

Ø 60	Diameter 60 mm
Ø 68	Diameter 68 mm
Type 3	Protection device to DIN EN 61643-11 or IEC 61643-11
LPZ 2→3	Transition from LPZ 2 to LPZ 3
AS	Acoustic signalling

Applications



FS	Remote signalling
AS	Acoustic signalling
ISDN	Integrated Service Digital Network, ISDN applications
DSL	Digital Subscriber Line, DSL applications
Analog TK	Analogue telecommunication
Cat 5	Category 5 TwisterPair
Cat 6	Channel Performance to American EIA/TIA standard
MSR	Measuring, controlling and regulating systems
TV	TV applications
SAT	SAT-TV applications
Mu	MultiBase base
LifeControl	LifeControl
EX	Intrinsically safe protection device for potentially explosive areas
Class E	Channel Performance to ISO / IEC 11801
PoE	Power over Ethernet
230/400 V System	230/400 V system
IP 54	Protection rating IP 54
IP 65	Protection rating IP 65

Lightning protection classes







Type 1	Protection device to DIN EN 61643-11 or IEC 61643-11
Type 1+2	Combination protection device made of type 1 and type 2
Type 2	Protection device to DIN EN 61643-11 or IEC 61643-11







Lightning protection classes

	Protection device to DIN EN 61643-11 or IEC 61643-11
	Protection device to DIN EN 61643-11 or IEC 61643-11



Lightning protection zone

	Transition from LPZ 0 to LPZ 1
	Transition from LPZ 0 to LPZ 2
	Transition from LPZ 0 to LPZ 3
	Transition from LPZ 1 to LPZ 2
	Transition from LPZ 1 to LPZ 3
	Transition from LPZ 2 to LPZ 3



BSS maintenance of electrical function installation

	Fire-tested systems
	Escape route ceiling mounting with pressure clip
	OBO Grip, wall routing type
	OBO Grip, ceiling routing type
	Pressure clip for maintenance of electrical function, ceiling mounting



BSS anchor

	Fire protection anchor
	Fire protection bolt tie

BSS test marks/material class

	Maintenance of electrical function class E30
	Maintenance of electrical function class E90













Clamp clip base shapes

	Clamp clip for C profile rail, slot width 11–12 mm
	Clamp clip for C profile rail, slot width 16–17 mm
	Clamp clip for C profile rail, slot width 18–22 mm



Diameter

	Diameter 60 mm
	Diameter 68 mm
	Diameter 70 mm
	Diameter 74 mm





Entries

	4 cable entries
	6 cable entries
	7 cable entries
	8 cable entries
	9 cable entries
	10 cable entries
	12 cable entries
	10 cable entries ECO
	12 cable entries ECO
	14 cable entries ECO
	16 cable entries
	18 cable entries ECO
	24 cable entries





Gland thread

	Thread metric
	Thread Pg





Entry size

	M20 entry
	M25 entry
	M32 entry
	M40 entry

KTS side heights

	Cable tray, side height 35 mm
	Cable tray, side height 60 mm
	Cable tray, side height 85 mm
	Mesh cable tray, slant height 35 mm
	Mesh cable tray, slant height 55 mm









Materials

	Flat steel
	Angular steel
	U steel
	Round material





Pictogram explanation







Nominal cross-section

	Nominal cross-section 1.5 mm ²
	Nominal cross-section 1.5–2.5 mm ²
	Nominal cross-section 2.5 mm ²
	Nominal cross-section 2.5–4 mm ²
	Nominal cross-section 4 mm ²
	Nominal cross-section 4–6 mm ²
	Nominal cross-section 6 mm ²
	Nominal cross-section 10 mm ²
	Nominal cross-section 16 mm ²





Nominal voltage

	Nominal voltage 400 V
	Nominal voltage 500 V
	Nominal voltage 660 V





Polarity

	3-pole
	5-pole
	7-pole
	8-pole
	10-pole
	12-pole

Slot widths

	Slot width 7.5 mm
	Slot width 11 mm
	Slot width 11–12 mm
	Slot width 12 mm
	Slot width 15 mm
	Slot width 16 mm
	Slot width 16.5 mm
	Slot width 16–17 mm
	Slot width 17 mm
	Slot width 18 mm
	Slot width 22 mm
	Slot width 35 mm











Screw heads

	Philips screw
	Torx screw
	Phillips screw
	Pozidrive





Firing devices

	Bolt-firing tool
	Nail device





Protection rating

	Protection rating IP 20
	Protection rating IP 30
	Protection rating IP 31
	Protection rating IP 44
	Protection rating IP 54
	Protection rating IP 55
	Protection rating IP 65
	Protection rating IP 66
	Protection rating IP 67
	Protection rating IP 68

Metals

	Aluminium
	Aluminium/steel
	Stainless steel, rustproof
	Stainless steel, rustproof
	Stainless steel, rustproof
	Copper
	Brass
	Steel
	Malleable iron
	Die-cast zinc

Plastics

	Acrylonitrile butadiene styrene
	Duroplast, Aminoplast, type 131.5
	Duroplast, melamine resin, type 150
	Ethylene vinyl acetate



Plastics

FA	Fibre-proof material DIN 28091
GFK	Fibre-glass-reinforced plastic
NBR SBR	Rubber mixture
NBR	Nitrile rubber
PETR	Petrolatum
PA	Polyamide
PA/ GF	Polyamide, fibre-glass reinforced
PBPT	Polybutylene terephthalate
PC	Polycarbonate
PE	Polyethylene
PP	Polypropylene
PP/GF	Polypropylene, fibre-glass reinforced
PS	Polystyrene
PVC	Polyvinylchloride
ZELL PE	Cellular polyethylene



GTIN	Item no.	Page	GTIN	Item no.	Page
	/pc.			/pc.	
6049974	6120388	24	5983330	6288572	29
6050024	6120390	24	5915027	6288574	29
6050031	6120392	24	5889106	6288576	29
6050154	6120412	24	5809128	6288577	29
6050208	6120414	24			
6050222	6120416	24	5090786	7400768	37
6050253	6120418	24			
6050260	6120420	24	5099871	7404400	33
6050277	6120422	24	5099888	7404404	33
6050314	6120432	25	5099895	7404408	34
6050321	6120434	25	5099901	7404412	33
6050345	6120436	25	6557516	7404660	12
6050376	6120438	25	6557523	7404662	12
6050383	6120440	25	6557554	7404664	12
6050390	6120442	25	6557561	7404670	12
6050437	6120452	25	6557578	7404672	14
6050444	6120454	25	6557585	7404674	12
6050468	6120456	25	6557615	7404676	13
6050499	6120458	25	6557622	7404678	13
6050505	6120460	25	6557646	7404680	13
6050512	6120462	25	6557639	7404682	14
6050550	6120482	26	6557677	7404684	14
6050567	6120484	26	6557684	7404686	14
6050581	6120486	26	6557691	7404688	13
6050611	6120488	26			
6050628	6120490	26	5109891	7406928	37
6050635	6120492	26			
6050673	6120502	26	5861300	7407047	76
6050680	6120504	26	5450771	7407663	55
6050703	6120506	26	5450788	7407665	55
6050734	6120508	26	5450825	7407667	56
6050741	6120510	26	5450832	7407669	55
6050758	6120512	26	5112730	7407688	77
6049851	6120722	48	5112839	7407712	77
6049868	6120724	48	5113027	7407764	76
6333578	6120782	54	5113034	7407768	73
6602889	6120797	54	5113072	7407776	75
6571161	6120832	26	5113089	7407780	72
6571178	6120834	26	5113096	7407784	73
6571185	6120836	26	5113102	7407788	73
	/pc.		5415978	7407790	74
6570805	6120920	58	5113133	7407792	74
6570812	6120922	58	5623489	7407798	75
6570829	6120924	58	5113157	7407800	74
6570836	6120926	58	5113164	7407804	75
6570843	6120928	58	5113195	7407808	75
6570850	6120930	58	5113201	7407812	75
6570867	6120932	58	5113218	7407816	76
6570874	6120934	58	5455806	7407817	76
6570881	6120936	58	5688624	7407818	76
6570898	6120938	59	5113225	7407820	72
6570911	6120940	59	5113256	7407824	73
6570928	6120942	59	5113263	7407828	73
6570935	6120950	59	5113270	7407832	74
6570942	6120952	59	5417965	7407833	74
6570959	6120954	59	5113287	7407836	72
6570966	6120960	60	5113294	7407840	72
6571000	6120962	60	5113300	7407844	72
6571017	6120964	60	5438694	7407894	36
6571024	6120966	60	5438700	7407896	36
6571031	6120968	60	5438717	7407898	36
6571048	6120970	60			
6571055	6120980	59	5674566	7408693	56
6571062	6120982	59			
6571079	6120984	59	5246435	7425600	33
6594702	6120992	60			
	price/m				
6277575	6154922	106			
6277995	6154930	106			
	/pc.				
6278350	6154961	106			
6278411	6154965	107			
6278473	6154968	106			
6278657	6154980	106			
6278718	6154983	106			
6691531	6288328	79			
6691548	6288330	79			
6691555	6288334	79			
6691562	6288336	79			
	/pc.				
5616559	6288365	79			

Gebäudeinstallation WAGO, Tischsteckdosen und Steckdosen, Schalter, Daten- und Multimediasteckdosen / en / 2021/06/24 09:42:21



OBO Bettermann Holding GmbH Co. KG

P.O. Box 1120
58694 Menden, Germany

Customer Service

Tel.: +49 23 73 89 - 17 00
Fax: +49 23 73 89 - 12 38
export@obo.de

www.obo-bettermann.com

Building Connections

