

DMP 331

Industrial Pressure Transmitter for Low Pressure

Stainless Steel Sensor

accuracy according to IEC 60770:
standard: 0.35 % FSO
option: 0.25 / 0.1 % FSO



Nominal pressure

from 0 ... 100 mbar up to 0 ... 60 bar

Output signals

2-wire: 4 ... 20 mA

3-wire: 0 ... 20 mA / 0 ... 10 V

others on request

Special characteristic

- ▶ perfect thermal behaviour
- ▶ excellent long term stability
- ▶ pressure port
G 1/2" flush from 100 mbar



Optional versions

- ▶ IS-version
Ex ia = intrinsically safe
for gases and dusts
- ▶ SIL 2-according to
IEC 61508 / IEC 61511
- ▶ welded pressure sensor
- ▶ customer specific versions

The pressure transmitter DMP 331 can be used in all industrial areas when the medium is compatible with stainless steel 1.4404 (316 L) or 1.4435 (316 L). Additional are different elastomer seals as well as a helium tested welded version available.

The modulare concept of the device allows to combine different stainless steel sensors and electronic modules with a variety of electrical and mechanical versions. Thus a diversity of variations is created, meeting almost all requirements in industrial applications.

Preferred areas of use are

-  Plant and machine engineering
-  Environmental engineering
(water - sewage - recycling)
-  Energy industry



Input pressure range									
Nominal pressure gauge	[bar]	-1...0	0.10	0.16	0.25	0.40	0.60	1	1.6
Nominal pressure abs.	[bar]	-	-	-	-	0.40	0.60	1	1.6
Overpressure	[bar]	5	0.5	1	1	2	5	5	10
Burst pressure ≥	[bar]	7.5	1.5	1.5	1.5	3	7.5	7.5	15

Nominal pressure gauge / abs.	[bar]	2.5	4	6	10	16	25	40	60
Overpressure	[bar]	10	20	40	40	80	80	105	105
Burst pressure ≥	[bar]	15	25	50	50	120	120	210	210
Vacuum resistance		$p_N \geq 1$ bar: unlimited vacuum resistance $p_N < 1$ bar: on request							

Output signal / Supply			
Standard	2-wire:	4 ... 20 mA / $V_S = 8 \dots 32 V_{DC}$	SIL-version: $V_S = 14 \dots 28 V_{DC}$
Option IS-protection	2-wire:	4 ... 20 mA / $V_S = 10 \dots 28 V_{DC}$	SIL-version: $V_S = 14 \dots 28 V_{DC}$
Options 3-wire	3-wire:	0 ... 20 mA / $V_S = 14 \dots 30 V_{DC}$ 0 ... 10 V / $V_S = 14 \dots 30 V_{DC}$	

Performance	
Accuracy ¹	standard: nominal pressure < 0.4 bar: $\leq \pm 0.50$ % FSO nominal pressure ≥ 0.4 bar: $\leq \pm 0.35$ % FSO option 1: nominal pressure ≥ 0.4 bar: $\leq \pm 0.25$ % FSO option 2: for all nominal pressure ranges: $\leq \pm 0.10$ % FSO
Permissible load	current 2-wire: $R_{max} = [(V_S - V_{S min}) / 0.02 A] \Omega$ current 3-wire: $R_{max} = 240 \Omega$ voltage 3-wire: $R_{min} = 10 k\Omega$
Influence effects	supply: 0.05 % FSO / 10 V load: 0.05 % FSO / $k\Omega$
Long term stability	$\leq \pm 0.1$ % FSO / year at reference conditions
Response time	2-wire: ≤ 10 msec 3-wire: ≤ 3 msec

¹ accuracy according to IEC 60770 – limit point adjustment (non-linearity, hysteresis, repeatability)

Thermal effects (offset and span)				
Nominal pressure p_N	[bar]	-1 ... 0	< 0.40	≥ 0.40
Tolerance band	[% FSO]	$\leq \pm 0.75$	$\leq \pm 1$	$\leq \pm 0.75$
in compensated range	[°C]	-20 ... 85	0 ... 70	-20 ... 85

Permissible temperatures	
Medium	-40 ... 125 °C
Electronics / environment	-40 ... 85 °C
Storage	-40 ... 100 °C

Electrical protection	
Short-circuit protection	permanent
Reverse polarity protection	no damage, but also no function
Electromagnetic compatibility	emission and immunity according to EN 61326

Mechanical stability	
Vibration	10 g RMS (25 ... 2000 Hz) according to DIN EN 60068-2-6
Shock	500 g / 1 msec according to DIN EN 60068-2-27

Materials	
Pressure port	stainless steel 1.4404 (316 L)
Housing	stainless steel 1.4404 (316 L)
Option compact field housing	stainless steel 1.4301 (304) cable gland M12x1.5, brass, nickel plated (clamping range 2 ... 8 mm)
Seals	standard: FKM options: EPDM welded version ² (for $p_N \leq 40$ bar) others on request
Diaphragm	stainless steel 1.4435 (316 L)
Media wetted parts	pressure port, seals, diaphragm

² welded version only with pressure ports according to EN 837, $p_N \leq 40$ bar

Explosion protection (only for 4 ... 20 mA / 2-wire)	
Approvals DX19-DMP 331	IBExU 10 ATEX 1068 X / IECEx IBE 12.0027X zone 0: II 1G Ex ia IIC T4 Ga zone 20: II 1D Ex ia IIIC T135 °C Da
Safety technical maximum values	$U_i = 28 \text{ V}$, $I_i = 93 \text{ mA}$, $P_i = 660 \text{ mW}$, $C_i \approx 0 \text{ nF}$, $L_i \approx 0 \text{ }\mu\text{H}$, the supply connections have an inner capacity of max. 27 nF to the housing
Permissible temperatures for environment	in zone 0: -20 ... 60 °C with p_{atm} 0.8 bar up to 1.1 bar in zone 1 or higher: -40/-20 ... 70 °C
Connecting cables (by factory)	cable capacitance: signal line/shield also signal line/signal line: 160 pF/m cable inductance: signal line/shield also signal line/signal line: 1 $\mu\text{H}/\text{m}$
Miscellaneous	
Option SIL2 version ³	according to IEC 61508 / IEC 61511
Current consumption	signal output current: max. 25 mA signal output voltage: max. 7 mA
Weight	approx. 200 g
Installation position	any ⁴
Operational life	100 million load cycles
CE-conformity	EMC Directive: 2014/30/EU
ATEX Directive	2014/34/EU

³ only for 4 ... 20 mA / 2-wire, not in combination with accuracy 0.1 %

⁴ Pressure transmitters are calibrated in a vertical position with the pressure connection down. If this position is changed on installation there can be slight deviations in the zero point for pressure ranges $p_N \leq 1 \text{ bar}$.

Wiring diagrams

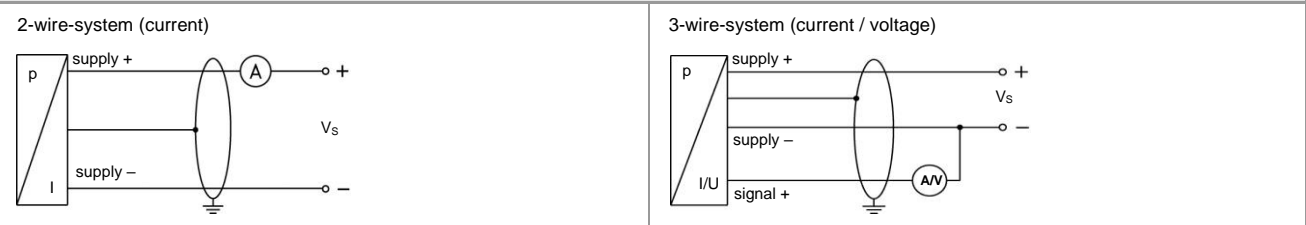

Pin configuration

Electrical connection	ISO 4400	Binder 723 (5-pin)	M12x1 / metal (4-pin)	Bayonet MIL-C-26482 (10-6)	
				2-wire	3-wire
Supply +	1	3	1	A	A
Supply -	2	4	2	B	D
Signal + (for 3-wire)	3	1	3	-	B
Shield	ground pin	5	4	pressure port	
Electrical connection	compact field housing		cable colours (IEC 60757)		
	V_{S+} , V_{S-} , $S+$, GND				
Supply +	V_{S+}		WH (white)		
Supply -	V_{S-}		BN (brown)		
Signal + (for 3-wire)	$S+$		GN (green)		
Shield	GND		GNYE (green-yellow)		

Electrical connections (dimensions mm / in)

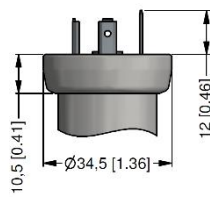

ISO 4400
(IP 65)

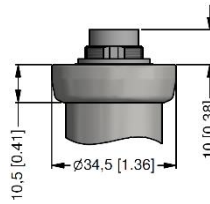

Binder series 723, 5-pin
(IP 67)

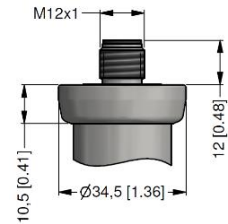

M12x1, 4-pin
(IP 67)

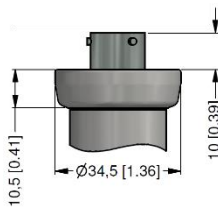

Bayonet MIL-C-26482 (10-6)
(IP 67)

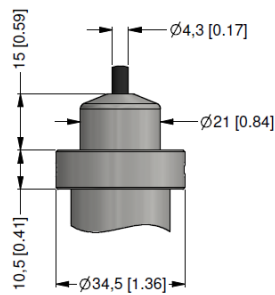

cable outlet with PVC cable
(IP 67)⁵

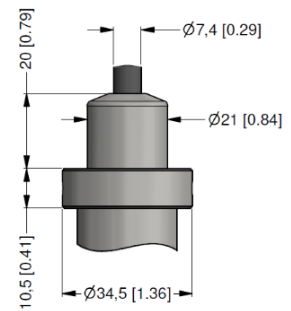

cable outlet, cable with
ventilation tube (IP 68)⁶

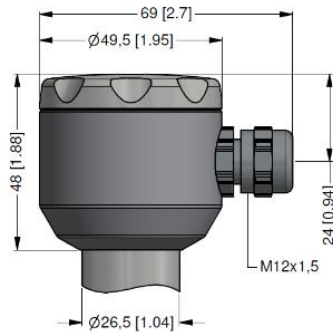

compact field housing
(IP 67)

⇒ universal field housing stainless steel 1.4404 (316 L) with cable gland M20x1.5 (ordering code 880) and other versions on request

⁵ standard: 2 m PVC cable without ventilation tube (permissible temperature: -5 ... 70 °C)

⁶ different cable types and lengths available, permissible temperature depends on kind of cable

Dimensions (mm / in)

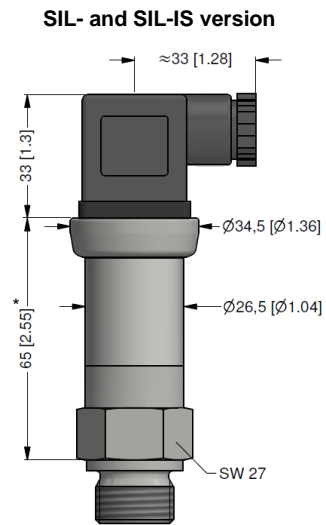
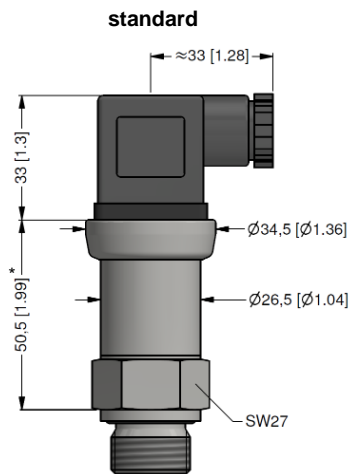

* with electrical connection Bayonet MIL-C-26482 (10-6) increases the length of devices by 5 mm

Mechanical connections (dimensions mm / in)

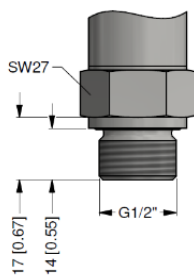

G1/2" DIN 3852

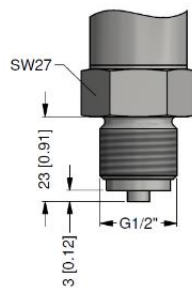

G1/2" EN 837

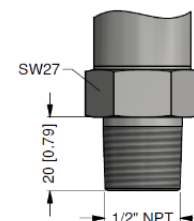

1/2" NPT

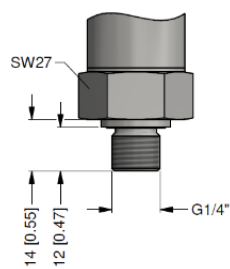

G1/4" DIN 3852

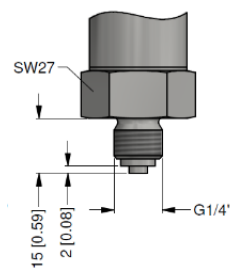

G1/4" EN 837

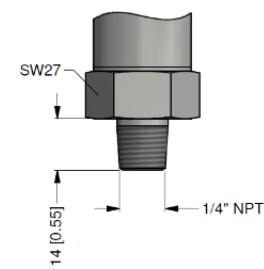

1/4" NPT

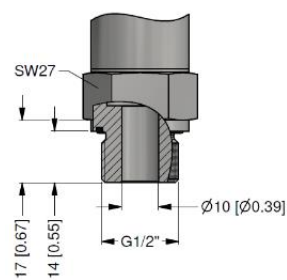

G1/2" open port DIN 3852
(pN ≤ 40 bar)

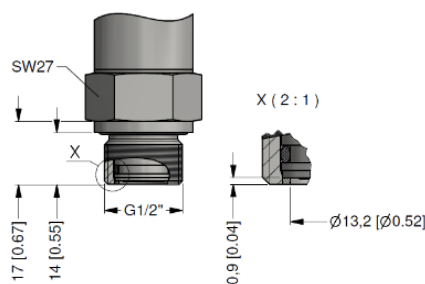

G1/2" flush DIN 3852
(pN ≤ 40 bar)

⇓ metric threads and other versions on request

© 2021 BD|SENSORS GmbH – The specifications given in this document represent the state of engineering at the time of publishing. We reserve the right to make modifications to the specifications and materials.

Ordering code DMP 331

DMP 331

Pressure		
gauge	1 1 0	
absolute ¹	1 1 1	
Input [bar]		
0.10 ¹	1 0 0 0	
0.16 ¹	1 6 0 0	
0.25 ¹	2 5 0 0	
0.40	4 0 0 0	
0.60	6 0 0 0	
1.0	1 0 0 1	
1.6	1 6 0 1	
2.5	2 5 0 1	
4.0	4 0 0 1	
6.0	6 0 0 1	
10	1 0 0 2	
16	1 6 0 2	
25	2 5 0 2	
40	4 0 0 2	
60	6 0 0 2	
-1 ... 0	X 1 0 2	
customer	9 9 9 9	consult
Output		
4 ... 20 mA / 2-wire	1	
0 ... 20 mA / 3-wire	2	
0 ... 10 V / 3-wire	3	
intrinsic safety 4 ... 20 mA / 2-wire	E	
SIL2 4 ... 20 mA / 2-wire	1S	
SIL2 with intrinsic safety 4 ... 20 mA / 2-wire	ES	
customer	9	consult
Accuracy		
standard for p _N ≥ 0.4 bar: 0.35 % FSO	3	
standard for p _N < 0.4 bar: 0.50 % FSO	5	
option 1 for p _N ≥ 0.4 bar: 0.25 % FSO	2	
option 2: 0.10 % FSO ²	1	
customer	9	consult
Electrical connection		
male and female plug ISO 4400	1 0 0	
male plug Binder series 723 (5-pin)	2 0 0	
cable outlet with PVC cable (IP67) ³	T A 0	
cable outlet,	T R 0	
cable with ventilation tube (IP68) ⁴	M 1 0	
male plug M12x1 (4-pin) / metal	B G 0	
Bayonet MIL-C-26482 (10-6); 2 wire	B G 4	
Bayonet MIL-C-26482 (10-6); 3 wire	8 5 0	
compact field housing		
stainless steel 1.4301 (304)	9 9 9	consult
customer		
Mechanical connection		
G1/2" DIN 3852	1 0 0	
G1/2" EN 837	2 0 0	
G1/4" DIN 3852	3 0 0	
G1/4" EN 837	4 0 0	
G1/2" DIN 3852 with flush sensor ⁵	F 0 0	
G1/2" DIN 3852 open pressure port ⁵	H 0 0	
1/2" NPT	N 0 0	
1/4" NPT	N 4 0	
customer	9 9 9	consult
Seals		
FKM	1	
EPDM	3	
without (welded version) ^{5, 6}	2	
customer	9	consult
Special version		
standard	0 0 0	
customer	9 9 9	consult

¹ absolute pressure possible from 0.4 bar

² not in combination with SIL

³ standard: 2 m PVC cable without ventilation tube (permissible temperature: -5 ... 70°C), others on request

⁴ code TR0 = PVC cable, cable with ventilation tube available in different types and lengths

⁵ only for p_N ≤ 40 bar

⁶ welded version only with pressure ports according to EN 837

© 2020 BDSENSORS GmbH - The specifications given in this document represent the state of engineering at the time of publishing. We reserve the right to make modifications to the specifications and materials.

01.04.2020