

Technical data sheet

Cap nut cable gland, metric thread, set with lock nut,
light grey
Art.-Nr. 2022764



The quickest and most convenient way of providing strain relief and tightness with cable glands on junction boxes and housings is with the tried-and-trusted V-TEC VM cable glands from OBO. A protection rating of IP68 is achieved through the integrated sealing lip and the special OBO slat technology. Strain relief and tightness have been tested to DIN EN 62444.

The connection threads are metric. Once screwed in place, the installation is there forever, as the optimum thread adjustment with the right pitch ensures permanent resistance to shaking. Applications: From private housing with junction boxes up to industrial applications in the distributor cabinet.

Temperature range: -20 °C to +65 °C.



PA Polyamide

Master data

Item no.	2022764
Type	V-TEC VM16+ LGR
Description 1	Cable gland
Description 2	with locknut
Dimension	M16
Colour	Light grey
RAL number	7035
Material	Polyamide
Material symbol	PA
Smallest sales unit	50,00 Piece
Weight	0,80 kg/100 pc.

Technical data sheet

Cap nut cable gland, metric thread, set with lock nut,
light grey

Art.-Nr. 2022764



Technical data

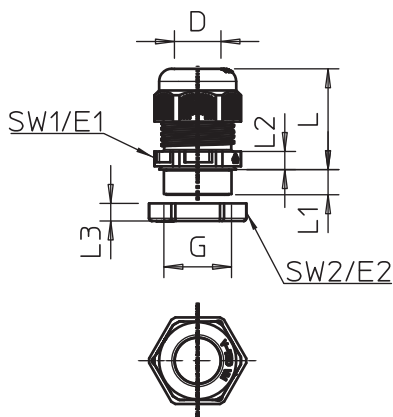

Dimension E1	22,00 mm
Dimension E2	25,00 mm
Dimension L min.	21,50 mm
Dimension L max.	23,50 mm
Dimension L1	8,00 mm
Dimension L2	5,00 mm
Dimension L3	5,00 mm
SW 1	20,00 mm
SW 2	22,00 mm
Version	Straight
Type of seal	Sealing ring
Bend protection	<input type="checkbox"/>
Sealing range D	4,50 - 10,00 mm
explosion-proof	<input type="checkbox"/>
Flat cable threaded connection	<input type="checkbox"/>
For Ex zone	Without
For Ex zone gas	Without
For Ex zone dust	Without
Flame resistant	Flame resistant to VDE 0471/DIN 695 Part 2-1, test temperature 650 °C
Thread	M16 x 1,5
Thread type	Metric
Thread length	8,00 mm
Thread increase	1,50 mm
Nominal thread size	16,00
Fibre-glass reinforced	<input type="checkbox"/>
Halogen-free	<input checked="" type="checkbox"/>
Installation torque	2,00 Nm
Multiple sealing insert	<input type="checkbox"/>
With locknut	<input type="checkbox"/>
Impact-resistant	<input type="checkbox"/>
Protection rating	IP68
Splittable gland	<input type="checkbox"/>
max. permitted ambient temperature	-20,00 - 65,00 °C
Strain relief option	<input checked="" type="checkbox"/>