

- Base device for Emergency Stop, Safety Gate and Light Grid applications
- Equivalent or non-equivalent activation selectable
- Two-channel activation including Cross Monitoring and Synchronous Time Check
- Automatic or Manual Start
- 3 enabling current paths
- For applications up to safety category 4
- Stop category 0
- Width 22.5mm
- Industrial design



## Technical data

### 1. Functions

Two-channel safety switching device with self-monitoring on each ON-OFF cycle. Monitoring of safety actuators for generating a safety-oriented output signal (enable) via forced output relay contacts.

### 2. Indicators

Green LED U ON: indication of supply voltage  
 Green LED K1 ON/OFF: safety channel 1 enabled  
 Green LED K2 ON/OFF: safety channel 2 enabled

### 3. Mechanical design

Self-extinguishing plastic housing, IP rating IP40  
 Mounted on DIN-Rail TS 35 according to EN 50022  
 Mounting position: any  
 Shockproof terminal connection according to VBG 4, IP rating IP20  
 Tightening torque: 0.5 to 0.6Nm  
 Terminal capacity:  
 2 x 0.14 to 0.75mm<sup>2</sup> without multicore cable end  
 1 x 0.14 to 2.5mm<sup>2</sup> without multicore cable end  
 2 x 0.25 to 0.5mm<sup>2</sup> flexible with multicore cable ends  
 1 x 0.25 to 2.5mm<sup>2</sup> flexible with multicore cable ends

### 4. Input circuit

Supply voltage: 24V AC/DC terminals A1-A2  
 Tolerance: 24V AC/DC -15% to +10%  
 Rated frequency: 50 to 60Hz  
 Rated consumption: 24V AC/DC 4.4VA (2.4W)  
 Duration of operation: 100%  
 Residual ripple bei DC: 2.4Vss

### 5. Output circuit

3 forced normally open contacts (enabling current paths)  
 Rated voltage: 230V AC / 300V DC  
 Rated current of enabling paths: max. 6A  
 Fusing: gG 6A (MCB 6 B or C)  
 Total current of all paths: max. 12A  
 Mechanical life: 10 x 10<sup>6</sup> operations  
 Switching capacity (according to IEC 947-5-1):  
 max. 6/min (AC-15: 4A/230V AC)  
 max. 60/min (AC-15: 3A/230V AC)  
 max. 6/min (DC-13: 4A/24V DC)  
 max. 60/min (DC-13: 2.5A/24V DC)  
 Insulation voltage: 300V AC (according to IEC 664-1)  
 Surge voltage: 4kV, overvoltage category III (according to IEC 664-1)  
 Release time  $t_R$  (K1, K2): 25ms

### 6. Safety circuit

Function: Connection of safety switching-devices (e.g. E-stop) or semiconductor output of safety actuator (OSSD)  
 Rated voltage: 22V DC  
 Input voltage range for semiconductor drive  
 high: 17.4V to 26.4V DC  
 low: -3.0V to +5V DC  
 Test pulse time ( $t_p$ ): ≤1ms, max. 10/s  
 Rated current: 40mA  
 Peak current: 100mA  
 Short circuit protection: short-circuit proof  
 Response time: -  
 Reset time: -  
 Safety channel 1 (CH1): terminals S11-S12  
 Safety channel 2 (CH2) cross monitoring: terminals S21-S22 (bridge S11-S31)  
 without cross monitoring: terminals S11-S31 (bridge S21-S22)  
 Synchronous time (CH1 before CH2): approx. 200ms  
 Synchronous time (CH2 before CH1): ∞  
 Input debouncing: No  
 Galvanic separation to power supply: No

### 7. Reset circuit

Function:  
 manual monitored reset: potential free normally open contact, terminals S33-S34  
 automatic start: bridge at terminals S33-S35  
 Rated voltage: 22V DC  
 Rated current: 5mA  
 Peak current: 50mA  
 Short circuit protection: short-circuit proof  
 Response time (K1, K2)  
 manual monitored start ( $t_{A1}$ ): max. 40ms  
 automatic start ( $t_{A2}$ ): max. 600ms  
 Pulse length  $t_M$ : min. 80ms  
 Galvanic separation to power supply: No

### 8. Ambient conditions

Ambient temperature: -25 to +55°C (according to IEC 68-1)  
 Storage temperature: -25 to +75°C  
 Transport temperature: -25 to +75°C  
 Relative Humidity: max. 83% (bei 23°C), max. 93% (bei 40°C) nach DIN 50016  
 Pollution degree: 3 outside, 2 inside (according to IEC 664-1)

## Functions

### Base functions:

#### Single-channel activation

Both safety channels are activated by only one contact of the safety actuator. (e.g. single-channel E-Stop switch)

#### Two-channel activation

Each safety channel of the safety relay is activated by an own contact of the safety actuator. (e.g. two-channel E-Stop switch)

#### Cross Monitoring:

The Cross Monitoring function detects short circuits between the two safety channels. To activate Cross Monitoring, safety channel 1 is connected to positive voltage (terminals S11-S12) and channel 2 is wired to mass (terminals S21-S22). To disable Cross Monitoring both channels are connected to positive voltage (terminals S12/S31-S11).

#### Synchronous Time Check

Synchronous Time Check is only possible in Automatic Start mode. If the contact at safety channel 1 is closed, contact at safety channel 2 has to be activated within the synchronous time  $t_s$  to activate the enabling current paths (LEDS K1 and K2 illuminated). If channel 2 is activated after the synchronous time has elapsed, the enabling current paths are not closed. In this case both channels have to be deactivated first before a new activation cycle can be started. If safety channel 2 is closed before safety channel 1 synchronous time is set to  $\infty$  to disable this monitoring function.

#### Single channel E-stop with Manual Start and Reset Monitoring

When the supply voltage is applied to terminals A1 and A2 (LED U illuminated) and the E-stop switch is not actuated (terminals S11-S12 closed), the Starting Lockout is effective. If the reset button at terminals S33-S34 is closed and opened again (Manual Start with Reset Monitoring) the output relays pick up within the response time  $t_{A1}$  (LED K1, K2 illuminated) and the enabling current paths (terminals 13-14, 23-24, 33-34) are closed.

If the E-stop switch is actuated, the output relays release within the release time  $t_{R1}$ .

If the supply voltage fails, the output relays release within the release time  $t_{R2}$ .

A reset of the safety relay can only be provided, if the e-stop switch has been unlocked again.

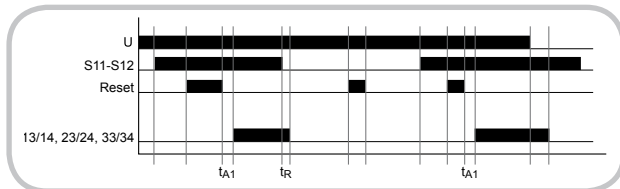

## Connections

### Starting Lockout

If the supply voltage is connected to terminals A1 and A2 and the safety contacts are closed, the output relays do not pick up until the reset button is actuated.

### Restarting Lockout

If the safety contacts are opened and closed again, the output relays do not pick up until the reset button is actuated.

### Automatic Start

If safety channels are closed correctly, the bridge at terminals S33-S35 provides an automatic start of the safety relay and the enabling current paths are closed. This function disables Starting and Restarting Lockout.

### Manual Start without Reset Monitoring

After closing the safety channels the output relays can be activated by closing the reset button at terminals S33-S35. Broken reset buttons are not monitored. This might cause an uncontrolled automatic start, if reset button fails

### Manual Start with Reset Monitoring

After closing the safety channels the output relays can be activated by pushing and releasing the reset button at terminals S33-S34. This ensures the correct operation of the connected reset button.

### OSSD-Compatibility

The two input channels of the safety relay can be actuated alternatively by semiconductor outputs of safety actuators (e.g. light grills). Test pulses of these output channels do not influence the function of the safety relay, as long as they do not exceed the maximum permissible test pulse time  $t_{TP}$ . Test pulses that do exceed  $t_{TP}$  will be monitored as a line break of the depending safety channel.

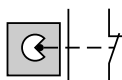
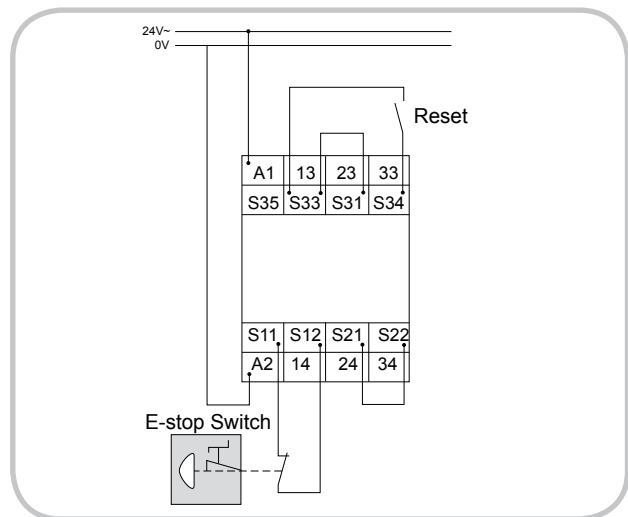

not actuated normally closed contact

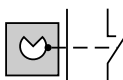

actuated normally closed contact

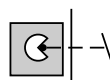

not actuated normally open contact

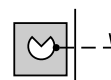

actuated normally open contact

## Functions

### Two-channel E-stop with Cross Monitoring and Manual Start with Reset Monitoring.

With the supply voltage connected to terminals A1-A2 (green LED U illuminated) and not actuated E-stop switch (terminals S21-S22 and S11-S12 closed) the output relays pick up within the response time  $t_{A1}$  (green LED K1 and K2 illuminated), as soon as the reset button at terminals S33-S34 is closed and opened again (Manual Start with Reset Monitoring).

If the E-stop switch is activated, the output relays release within the release time  $t_{R1}$  (terminals 13-14, 23-24 and 33-34 open) and the enabling current paths are interrupted.

If the supply voltage fails, the output relays release within the release time  $t_{R2}$ .

A restart of the safety relay can only be provided, after the E-stop switch has been unlocked again.

If in case of a fault only one of the two safety channels is opened, the output relays release and get locked until both safety channels have been opened and closed again.

If a short circuit to ground or an interwire short circuit occurs, the cross monitoring function deactivates the output relays within the release time.

A restart of the safety relay can only be provided, if the short circuit has been removed.

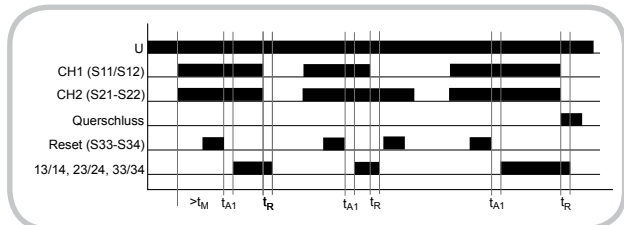

### Two-channel E-stop without Cross Monitoring with manual monitored start

The function is equal to two-channel E-stop with cross monitoring, but interwire short circuits between the safety channels are not monitored.

### Two-channel Safety Gate Monitoring with Cross Monitoring and Automatic Start

If the supply voltage applies at terminals A1-A2 (LED U illuminated), the bridge at terminals S33-S35 provides an automatic start of the safety relay as soon as contacts S1 (terminals S11-S12) and S2 (terminals S21-S22) are closed.

If the contacts are positioned in a way, that S1 gets closed before S2, synchronism of the activation is monitored. In this case the output relays (K1, K2) only pick up, if contacts S1 and S2 get activated within the synchronous time. If S2 is closed before S1 synchronism is not monitored.

If a short circuit to ground or an interwire short circuit is monitored, the Cross Monitoring function deenergizes the output relays and the enabling current paths are opened within the release time  $t_{R1}$ . A reset of the safety relay can only be executed, if the short circuit has been removed.

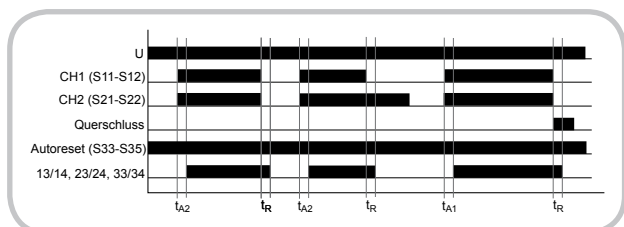

## Connections

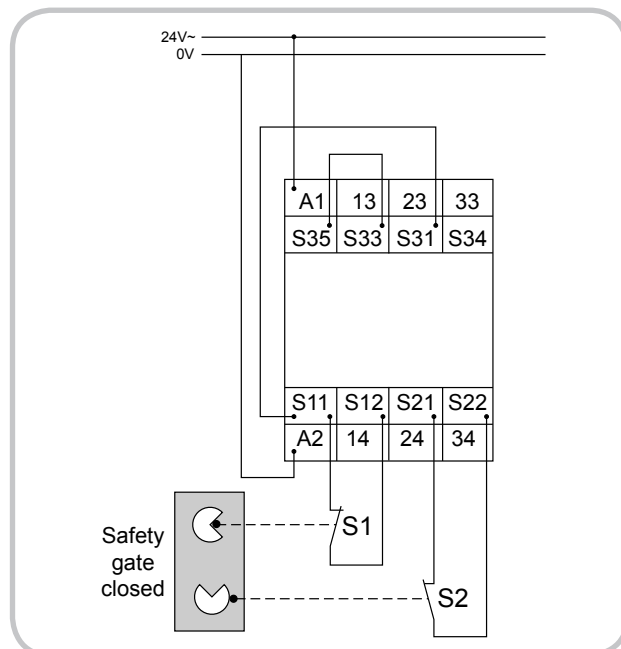
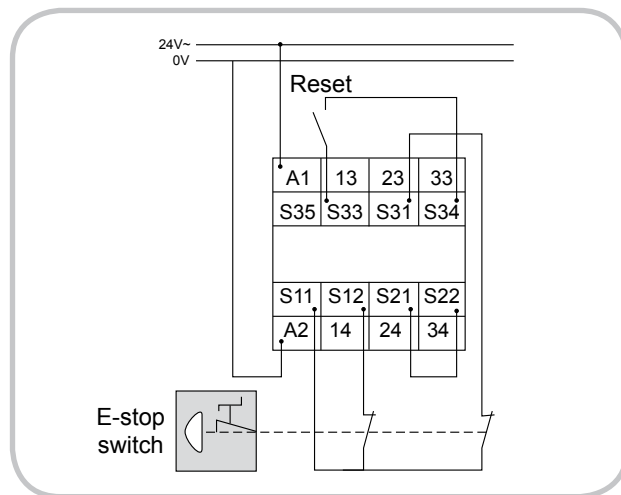
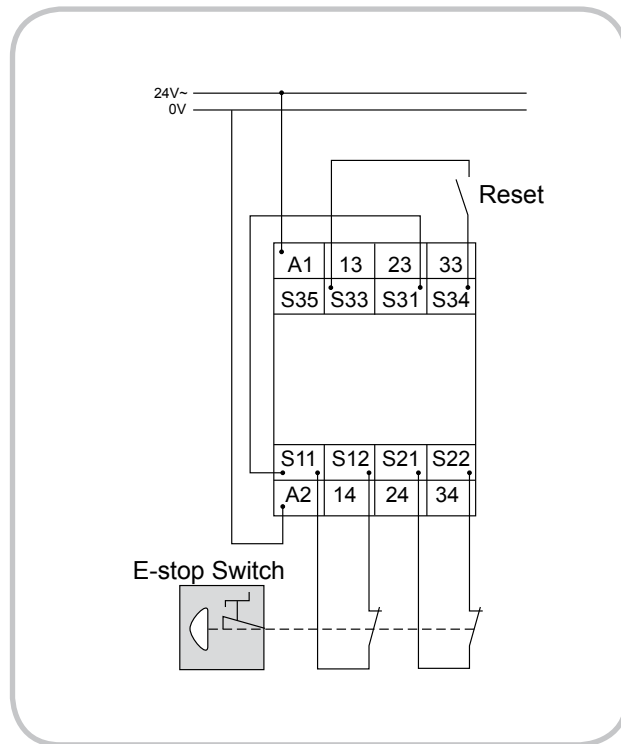

## Functions

### Monitoring safety switching devices with semiconductor output (OSSD)

With the supply voltage connected to terminals A1-A2 (green LED U illuminated), the output relays K1 and K2 pick up, as soon as a high signal is connected to safety channel 1 and 2 (terminals S12, S31). If signaling voltage is connected to S12 first, synchronism of activation is monitored. In that case the signaling voltage has to be applied to S31 within the synchronous time  $t_s$  to activate the output relays K1 and K2.

If at least one of the safety channels is deenergized longer than the maximum permissible test pulse time  $t_{TP}$ , the output relays release within the release time  $t_{R1}$ . A restart of the safety relay is disabled until both safety channels have been deenergized.

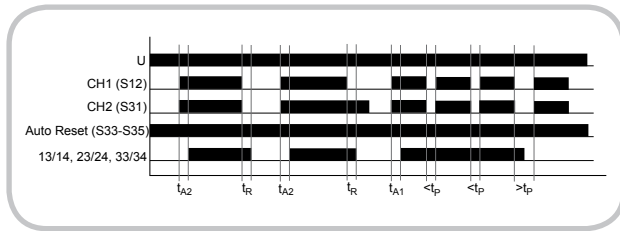

Internal circuitry

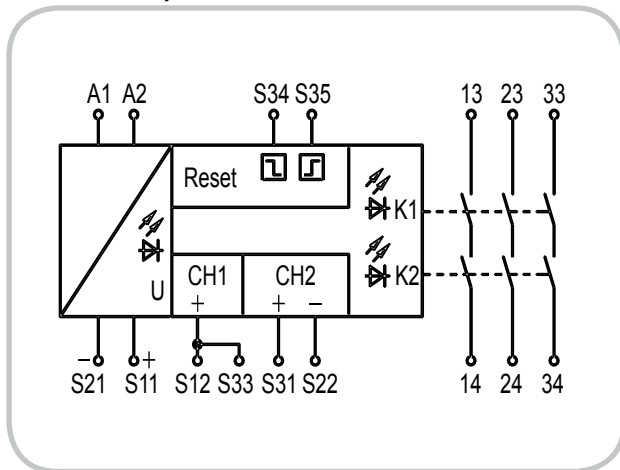

## Connections

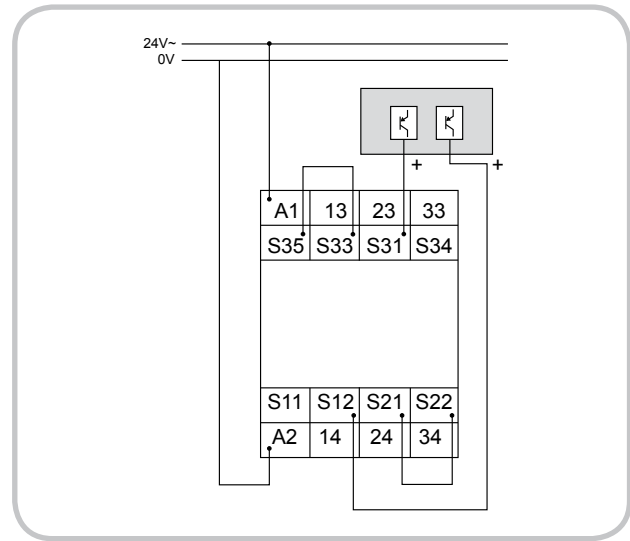

## Dimensions

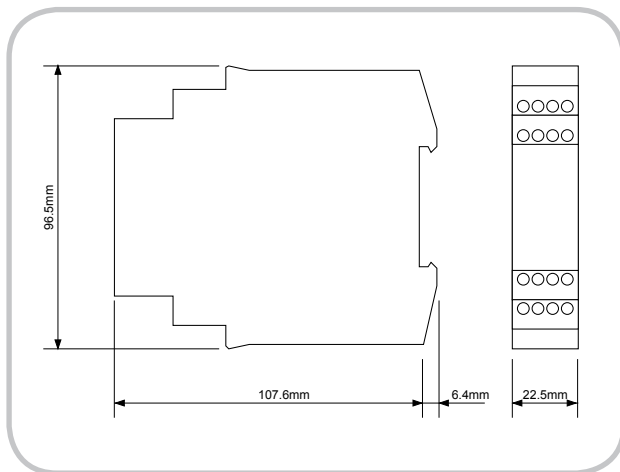

Subject to alterations and errors