

- ▶ Base device for Emergency Stop and Safety Gate applications
- ▶ Equivalent or non-equivalent activation selectable
- ▶ Two-channel activation including cross monitoring and synchronous time check
- ▶ Automatic or Manual Star
- ▶ 3 enabling current paths
- ▶ For applications up to safety category 4
- ▶ Stop category 0
- ▶ Width 22.5mm
- ▶ Industrial design



Technical data

1. Functions

Two-channel safety switching device with self-monitoring on each ON-OFF cycle and forced output relay contacts. Monitoring of equivalent or non-equivalent switching safety devices for generating a safety-oriented output signal (enable).

2. Indicators

Green LED U ON: indication of supply voltage
 Green LED K1 ON/OFF: safety channel 1 enabled
 Green LED K2 ON/OFF: safety channel 2 enabled

3. Mechanical design

Self-extinguishing plastic housing, IP rating IP40
 Mounted on DIN-Rail TS 35 according to EN 50022
 Mounting position: any
 Shockproof terminal connection according to VBG 4,
 IP rating IP20
 Tightening torque: 0.5 to 0.6Nm
 Terminal capacity:
 2 x 0.14 to 0.75mm² without multicore cable end
 1 x 0.14 to 2.5mm² without multicore cable end
 2 x 0.25 to 0.5mm² flexible with multicore cable ends
 1 x 0.25 to 2.5mm² flexible with multicore cable ends

4. Input circuit

Supply voltage: 24V AC/DC terminals A1-A2
 Tolerance: 24V AC/DC -15% to +10%
 Rated frequency: 50 to 60Hz
 Rated consumption: 24V AC/DC 3.2VA (2.6W)
 Duration of operation: 100%
 Residual ripple bei DC: 2.4Vss

5. Output circuit

3 forced normally open contacts (enabling current paths)
 Rated voltage: 230V AC / 300V DC
 Rated current of enabling paths: max. 6A
 Fusing: gG 6A (MCB 6 B or C)
 Total current of all paths: max. 12A
 Mechanical life: 10 x 10⁶ operations
 Switching capacity (according to IEC 947-5-1):
 max. 6/min (AC-15: 4A/230V AC)
 max. 60/min (AC-15: 3A/230V AC)
 max. 6/min (DC-13: 4A/24V DC)
 max. 60/min (DC-13: 2.5A/24V DC)
 Insulation voltage: 300V AC (according to IEC 664-1)
 Surge voltage: 4kV, overvoltage category III
 (according to IEC 664-1)
 Release time t_R (K1, K2): 25ms

6. Safety circuit

Function: connection of safety switching devices (e.g. E-stop actuator)
 Rated voltage: 22V DC
 No load voltage (AC-devices): <40V
 Rated current: 40mA
 Peak current: 100mA
 Short circuit protection: short circuit proof transformer
 Safety channel 1 (CH1): terminals S13-S14
 Safety channel 2 (CH2):
 equivalent activation: terminals S23-S24
 non-equivalent activation: terminals S13-S22
 Synchronous time (CH1 before CH2): approx. 200ms
 Synchronous time (CH2 before CH1): ∞
 Cross monitoring (CH1, CH2) Yes
 Galvanic separation to power supply: No

7. Reset circuit

Function:
 manual monitored start: potential free normally open contact terminals S33-S34
 automatic start: terminals S14-S35 bridged
 Rated voltage: 22V DC
 No load voltage: <40V
 Rated current: 5mA
 Peak current: 50mA
 Short circuit protection: short circuit proof transformer
 Response time (K1, K2)
 manual start (t_{A1}): 40ms
 automatic start (t_{A2}): 600ms
 Pulse length t_M: min. 50ms
 Galvanic separation to power supply: No

8. Ambient conditions

Ambient temperature: -25 to +55°C
 (according to IEC 68-1)
 Storage temperature: -25 to +70°C
 Transport temperature: -25 to +70°C
 Relative Humidity: max. 83% (bei 23°C),
 max. 93% (bei 40°C)
 nach DIN 50016
 Pollution degree: 3 outside, 2 inside
 (according to IEC 664-1)

Functions

Base functions:

Two-channel activation

Each safety channel of the safety relay is activated by an own contact of the safety actuator. (e.g. two-channel E-Stop switch)

Cross Monitoring:

The Cross Monitoring function detects short circuits between the two safety channels. With equivalent activation cross monitoring is achieved by means of the short circuit principle, with non-equivalent activation it is achieved by functional diversity.

Synchronous Time Check

Synchronous Time Check is only possible in Automatic Start mode. If the contact at safety channel 1 is closed, contact at safety channel 2 has to be activated within the synchronous time t_s to activate the enabling current paths (LEDS K1 and K2 illuminated). If channel 2 is activated after the synchronous time has elapsed, the enabling current paths are not closed (LEDs K1 illuminated, K2 not illuminated). In this case both channels have to be deactivated first before a new activation cycle can be started.

If safety channel 2 is closed before safety channel 1 synchronous time is set to ∞ to disable this monitoring function.

Equivalent activation

Both safety channels are activated by congenerous signal types. If the contacts at terminals S13-S14 and S23-S24 get closed, the enabling current paths can be activated by a reset. The enabling current paths are deactivated as soon as at least one contact is opened again.

Non-equivalent activation

The safety channels are activated by non-congenerous signal types. To activate the enabling current paths by a reset, the contact at terminals S13-S14 has to be closed and contact at terminals S13-S22 has to be opened.

Two-channel E-stop equivalent activated and Manual Start with Reset Monitoring

With the supply voltage connected to terminals A1-A2 (green LED U illuminated) and not actuated E-stop switch (terminals S13-S14 and S23-S24 closed) the output relays pick up within the response time t_{A1} (green LED K1 and K2 illuminated), as soon as the reset button at terminals S33-S34 is closed and opened again (Manual Start with Reset Monitoring).

If the E-stop switch is activated (terminals S13-S14 and S23-S24 opened), the output relays release within the release time t_R and the enabling current paths are interrupted.

If the supply voltage fails, the output relays release within the release time t_R .

A restart of the safety relay can only be provided, after the E-stop switch has been unlocked again.

If in case of a fault only one of the two safety channels is opened, the output relays release and get locked until both safety channels have been opened and closed again.

If a short circuit to ground or an interwire short circuit occurs, the cross monitoring function deactivates the output relays within the release time.

A restart of the safety relay can only be provided, if the short circuit has been removed.

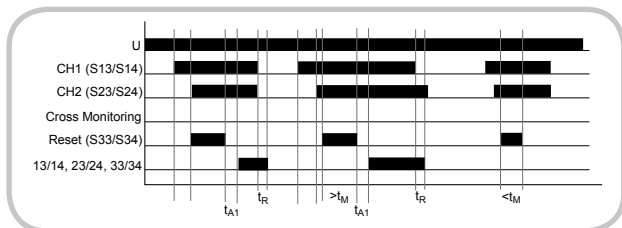

Connections

Starting Lockout

If the supply voltage is connected to terminals A1 and A2 and the safety contacts are closed, the output relays do not pick up until the reset button is actuated.

Restarting Lockout

If the safety contacts are opened and closed again, the output relays do not pick up until the reset button is actuated.

Automatic Start

If safety channels are closed correctly, the bridge at terminals S33-S35 resp. S14-S35 provides an automatic start of the safety relay and the enabling current paths are closed. This function disables Starting and Restarting Lockout.

Manual Start without Reset Monitoring

After closing the safety channels the output relays can be activated by closing the reset button at terminals S33-S35. Broken reset buttons are not monitored. This might cause an uncontrolled automatic start, if reset button fails

Manual Start with Reset Monitoring

After closing the safety channels the output relays can be activated by pushing and releasing the reset button at terminals S33-S34. This ensures the correct operation of the connected reset button.

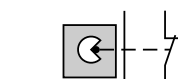
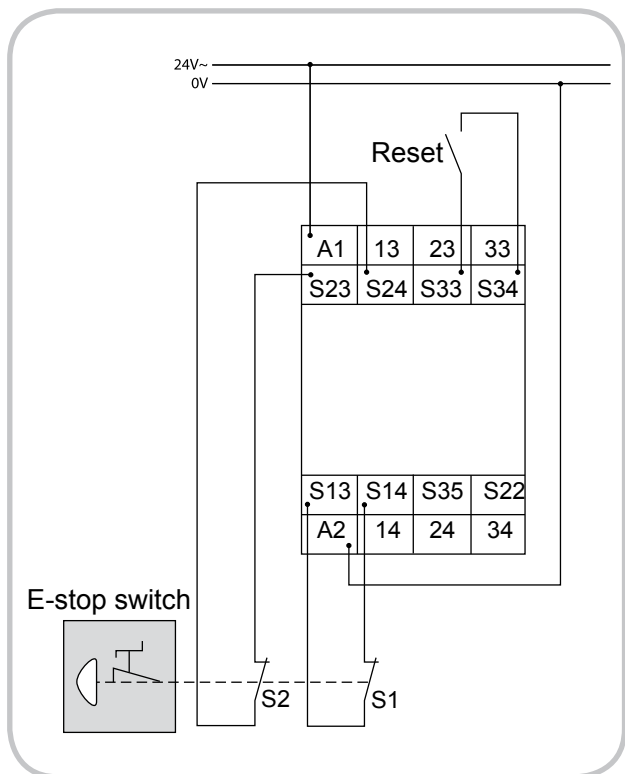

not actuated normally closed contact

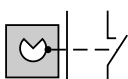

actuated normally closed contact

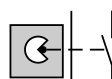

not actuated normally open contact

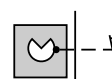

actuated normally open contact

Functions

Two-channel safety gate application equivalent activated with Automatic Start

If the supply voltage applies at terminals A1-A2 (LED U illuminated), the bridge at terminals S14-S35 provides an automatic start (Reset) of the safety relay as soon as the safety limit switch contacts S1 (terminals S13-S14) and S2 (terminals S23-S24) get closed.

If the contacts are positioned in a way, that S1 gets closed before S2, synchronism of the activation is monitored. In this case the output relays (K1, K2) only pick up, if contacts S1 and S2 get activated within the synchronous time. If S2 is closed before S1 synchronism is not monitored.

If a short circuit to ground or an interwire short circuit occurs, the cross monitoring function deactivates the output relays within the release time.

A restart of the safety relay can only be provided, if the short circuit has been removed.

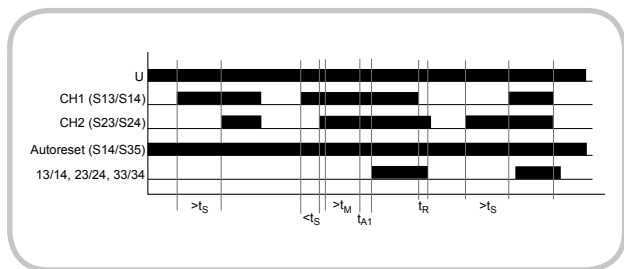

Connections

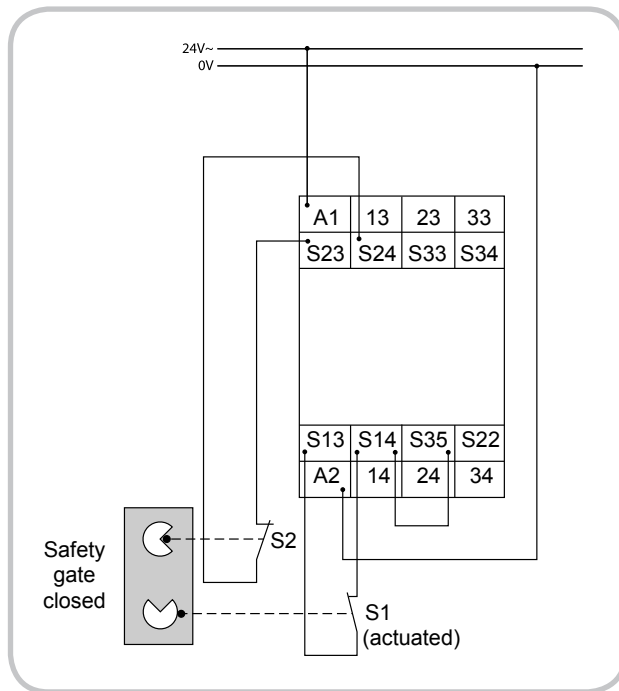

Two-channel safety gate application non-equivalent activated and Manual Start with Reset Monitoring

If the supply voltage applies at terminals A1-A2 (LED U illuminated), and with safety channel 1 (terminals S13-S14) closed and safety channel 2 (terminals S13-S22) opened, the output relays pick up within the response time t_{A1} (green LED K1 and K2 illuminated), as soon as the reset button at terminals S33-S34 is closed and opened again (Manual Start with Reset Monitoring).

If the protective gate is opened (terminals S13-S14 opened and S13-S22 closed), the output relays release within the release time t_R . If in case of a fault only one of the two safety channels is switched, the output relays release and get locked until both safety channels have been actuated.

If a short circuit to ground or an interwire short circuit occurs, the Cross Monitoring function deactivates the output relays within the release time.

A restart of the safety relay can only be provided, if the short circuit has been removed.

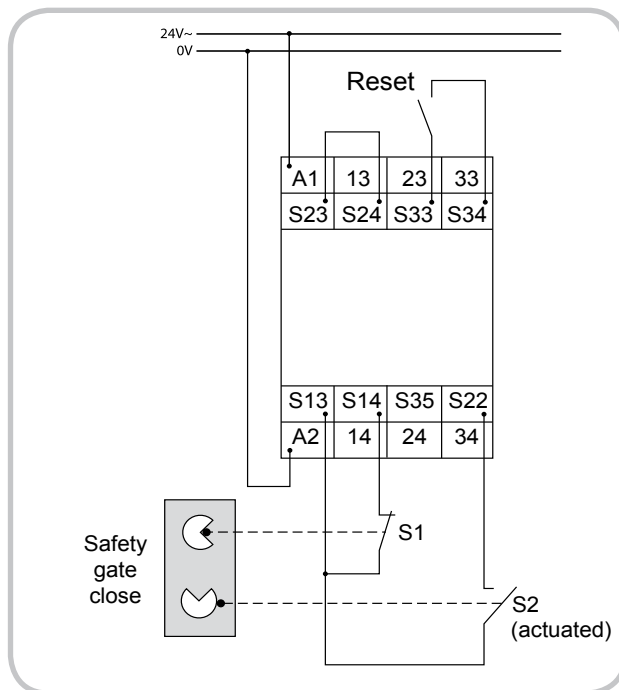
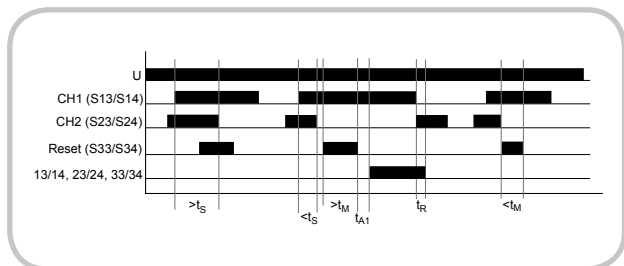

Subject to alterations and errors

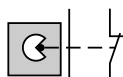

not actuated normally closed contact

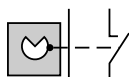

actuated normally closed contact

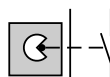

not actuated normally open contact

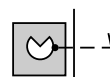

actuated normally open contact

Functions

Two-channel safety gate application non-equivalent activated and Automatic Start

If the supply voltage applies at terminals A1-A2 (LED U illuminated), the bridge at terminals S14-S35 provides an automatic start (Reset) of the safety relay as soon as the safety limit switch contact S1 (terminals S13-S14) is closed and S2 (terminals S23-S24) is opened. The output relays pick up within the response time t_{A1} (green LED K1 and K2 illuminated).

If the contacts are positioned in a way, that S1 is switched before S2, synchronism of the activation is monitored. In this case the output relays (K1, K2) only pick up, if contacts S1 and S2 get switched within the synchronous time. If S2 is opened before S1 is closed synchronism is not monitored.

If a short circuit to ground or an interwire short circuit occurs, the cross monitoring function deactivates the output relays within the release time.

A restart of the safety relay can only be provided, if the short circuit has been removed.

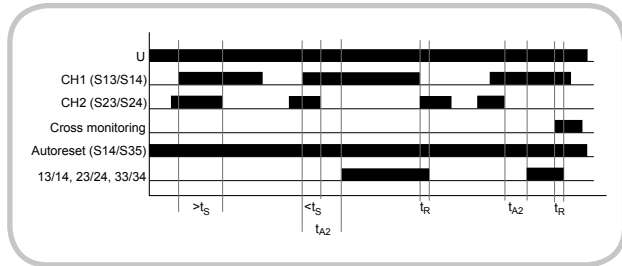

Connections

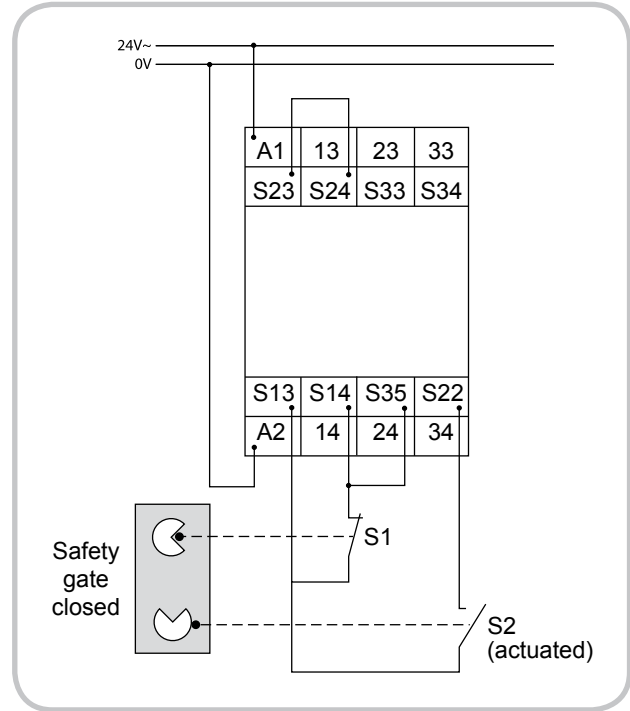

Dimensions

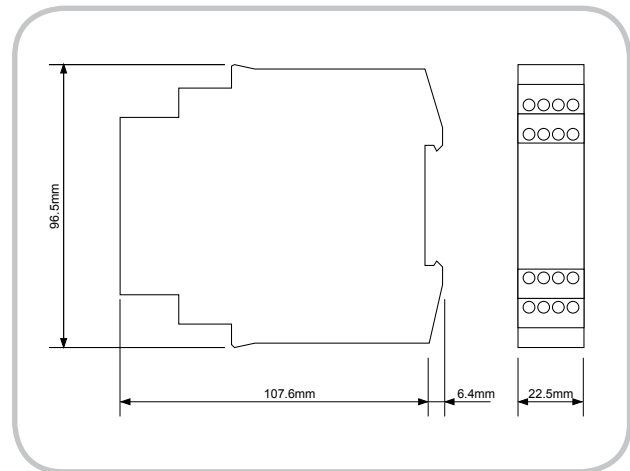

Internal circuitry

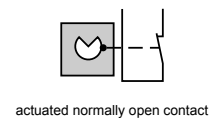
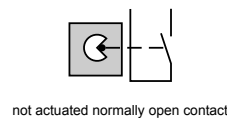
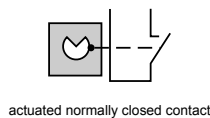
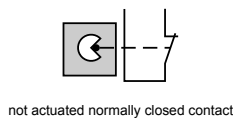
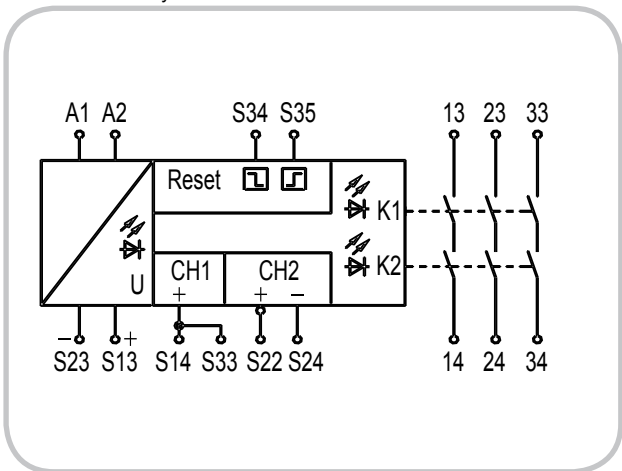

Subject to alterations and errors