

Technical data sheet

Fine protection device TELE 4-F for ISDN RJ11

Item no. 5081977



Data line protection device for analogue telecommunications systems

- In aluminium housing
- With 2-stage protection circuit
- Simple mounting
- Incl. 150 mm connection cable with RJ11 and/or RJ45 connectors
- Optimised bandwidth for TC systems
- DIN rail mounting with DLS-BS accessories (5082 38 2)

Application: For analogue telecommunication systems



Additional product text 1

- In aluminium housing
- Simple mounting on hat rail or on terminal
- Incl. 150 mm connection cable with RJ411 connectors
- Optimised bandwidth for telecommunications systems

Dimensions

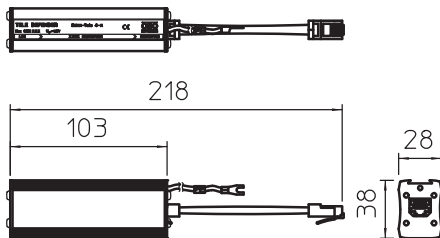

Master data

Item no.	5081977
Type	RJ11-TELE 4-F
Description 1	Fine protection device
Description 2	for analogue telecommunication
Dimension	170V
Smallest sales unit (VG)	1,00 Piece
Weight	14,00 kg/100 pc.

Technical data sheet

Fine protection device TELE 4-F for ISDN RJ11

Item no. 5081977



Technical data

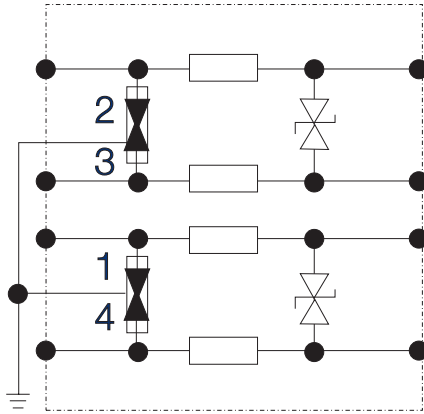

Category	Type 2+3 / C2+C1
SPD to IEC 61643-21	Class II+III / C2+C1
Version	Fine protection, 4 wires
Number of poles	4,00
Insertion loss	≤3 dB
Earthing via:	Connection cable
Total discharge current (8/20)	4 kA
Frequency range	0 - 18 MHz
Frequency range	0,00 - 18,00 MHz
Cut-off frequency	18,00 MHz
Maximum continuous voltage AC	120,00 V
Maximum continuous voltage DC	170,00 V
Insulation resistance	> 34 MΩ
Capacity (wire-wire)	<500 pF
Capacity (wire-earth)	<20 pF
Lightning protection zone LPZ	1→3
Rated current	0,30 A
Nominal load current AC	0,20 A
Nominal load current DC	0,30 A
Installation type	Connector/cable adapter
Testing standard	IEC 61643-21
Protection rating	IP40
Protection level wire-wire	<300 V
Protection level wire-earth	<600 V
Protection level, wire-earth at 1 kV/μs (C3)	<245 V
Series resistance per wire	2,2 Ω ± 10 %
Signalling on device	Without
Connection system	RJ11
Impulse durability wire-wire	C1: 1 kV / 0,5 kA (8/20)
Impulse durability wire-earth	C2: 2 kV / 1 kA (8/20)
Temperature range	-40+80 °C