

Technical data sheet

Protection for field devices, 3-pole, 24 V, NPT

Item no. 5098392

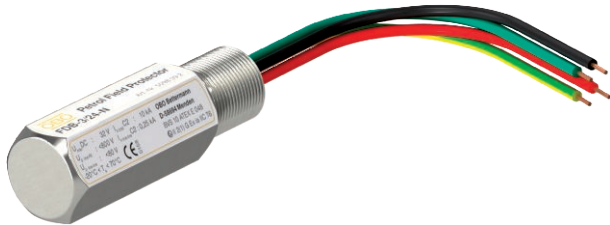

Petrol Field Protector FDB for intrinsically safe measuring circuits and bus systems

- NPT connection technology
- Low protection level at high current load
- Easy mounting on field devices
- Negligible internal capacitance and inductance
- Stainless steel housing with pressure-resistant encapsulation
- ATEX approval: II 2(1) G Ex ia [ia Ga] IIC T4..T6 Gb (BVS 10 ATEX E 048)

Application: Flow sensors, temperature sensors



Dimensions

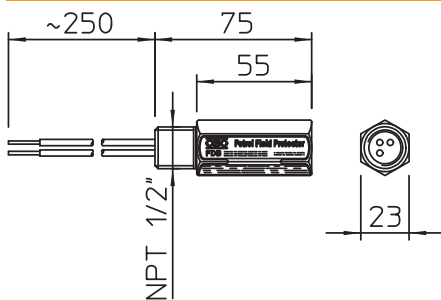

Master data

Item no.	5098392
Type	FDB-3 24-N
Description 1	Petrol Field Protector
Description 2	with npt external thread
Dimension	32V
Smallest sales unit (VG)	1,00 Piece
Weight	19,50 kg/100 pc.

Technical data sheet

Protection for field devices, 3-pole, 24 V, NPT



Item no. 5098392

Technical data

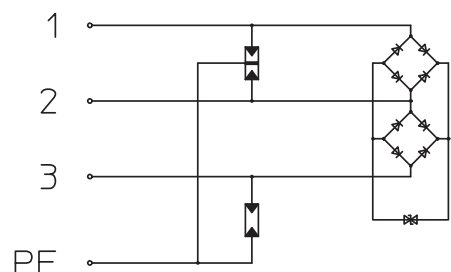

Category	Type 2+3 / C2+C1
SPD to IEC 61643-21	Class II+III / C2+C1
Version	3-pole; NPT
Number of poles	3,00
Earthing via:	Connection cable
Explosion-tested version	<input checked="" type="checkbox"/>
EX approval	II 2(1)G Ex ia [ia Ga] IIC T4..T6 Gb (BVS 10 ATEX E 048)
Telecommunications contact	<input type="checkbox"/>
Housing material	V2A
Total discharge current (8/20)	10 kA
Maximum continuous voltage AC	22,00 V
Maximum continuous voltage DC	32,00 V
Capacity (wire-wire)	< 17 pF
Capacity (wire-earth)	< 26 pF
Lightning protection zone LPZ	1→3
Mounting of input / output	1/2" NPT
Mounting of field / device side:	Connection cable 1.5 mm ² Length ~ 250 mm
Installation type	Screw-on
Testing standard	IEC 61643-21
Protection rating	IP65/67
Protection level wire-wire	<80 V
Protection level wire-earth	<800 V
Signalling on device	None
Impulse durability wire-wire	C1: 0,5 kV / 0,25 kA (8/20µs)
Impulse durability wire-earth	C2: 5 kV / 2,5 kA (8/20µs)
Temperature range	-20-+70 °C